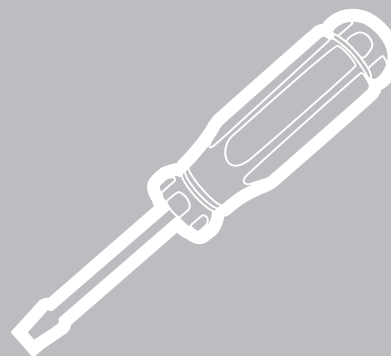


**hp** LaserJet  
3015 • 3020 • 3030  
all-in-one



i n v e n t

**service**





HP LaserJet 3015, 3020, and 3030 all-in-one

**Service Manual** \_\_\_\_\_

## Copyright Information

© Copyright 2004 Hewlett-Packard Development Company, L.P.

Reproduction, adaptation or translation without prior written permission is prohibited, except as allowed under the copyright laws.

The information contained herein is subject to change without notice.

The only warranties for HP products and services are set forth in the express warranty statements accompanying such products and services. Nothing herein should be construed as constituting an additional warranty. HP shall not be liable for technical or editorial errors or omissions contained herein.

Part number Q2665-90901

Edition 1, 01/2004

## Trademark Credits

Adobe® and PostScript® are trademarks of Adobe Systems Incorporated.

Microsoft®, Windows®, and Windows NT® are U.S. registered trademarks of Microsoft Corporation.

## Safety Information

**WARNING!**

Potential Shock Hazard

Always follow basic safety precautions when using this product to reduce risk of injury from fire or electric shock.

Read and understand all instructions in the user guide.

Observe all warnings and instructions marked on the product.

Use only a grounded electrical outlet when connecting the HP LaserJet 3015, 3020, and 3030 all-in-one products to a power source. If you don't know whether the outlet is grounded, check with a qualified electrician.

Do not touch the contacts on the end of any of the sockets on the HP LaserJet 3015, 3020, or 3030 all-in-one. Replace damaged cords immediately.

Unplug this product from wall outlets before cleaning.

Do not install or use this product near water or when you are wet.

Install the product securely on a stable surface.

Install the product in a protected location where no one can step on or trip over the power cord and the power cord will not be damaged.

If the product does not operate normally, see the online user guide.

Refer all servicing questions to qualified personnel.



# Table of contents

## 1 Product Information

Product configurations.....	2
HP LaserJet 3015, 3020, and 3030 all-in-one products.....	2
HP LaserJet 3015 all-in-one product.....	3
HP LaserJet 3020/3030 all-in-one product.....	3
Product features .....	4
Overview of products.....	5
Hardware components.....	5
Product identification.....	7
Model and serial numbers.....	7
Product specifications.....	8
Physical specifications.....	8
Environmental specifications (all models).....	8
HP LaserJet 3015 performance specifications.....	8
HP LaserJet 3020/3030 performance specifications.....	10
Electrical specifications (all models).....	12
Acoustic emissions (all models).....	12
Skew specifications (all models).....	12
HP LaserJet 3030 fax capabilities.....	13
HP LaserJet 3015, 3020, and 3030 all-in-one battery.....	14
Warranty statement.....	15
HP's Premium Protection print-cartridge warranty.....	16
Extended warranty.....	17
Print-cartridge information .....	18
Refilled print cartridges .....	18
HP LaserJet printing supplies .....	18
HP Printing Supplies Returns and Recycling Program information.....	18
FCC regulations.....	20
Telephone Consumer Protection Act (United States).....	22
IC CS-03 requirements.....	23
Declaration of Conformity .....	24
Safety statements.....	25
Laser safety statement.....	25
Canada DOC regulations.....	25
Laser statement for Finland.....	26
Korean EMI statement.....	26
Australian EMC requirements.....	26
Regulatory information for the European Union countries/regions .....	27

## 2 Operation

Operating environment.....	30
Identifying the control-panel components.....	31
Control-panel menu structure.....	33
To use the control-panel buttons.....	33
To print the control-panel menu structure.....	33

Product media specifications .....	37
Main input tray (all models) .....	37
Automatic document feeder (ADF) specifications.....	38
To gain access to the optimizing feature.....	38
Guidelines for using media.....	39
Paper and transparencies .....	39
Common media problems table.....	39
Labels.....	40
Envelopes.....	40
Card stock and heavy media .....	41
Loading media .....	43
Media input tray .....	43
Priority input tray .....	43
Specific types of media .....	43
Media information for ADF originals .....	43
Media information for the flatbed (HP LaserJet 3020 and 3030) .....	44
Loading originals to copy or scan.....	44
Loading originals into the LJ 3020 and 3030 ADF input tray.....	45
Loading originals onto the LJ 3020 and 3030 flatbed scanner.....	46

### 3 Maintenance

Life expectancies of parts that wear .....	48
Scanner calibration .....	49
Cleaning the product .....	50
To clean the print path .....	50
Cleaning the glass.....	50
Cleaning the print-cartridge area.....	54
To cleaning the print-cartridge area (all models).....	54
Cleaning the printer pickup roller (all models).....	55
Cleaning the printer separation pad (all models).....	56
User replaceable parts.....	57
Printer pickup roller (all models).....	57
Printer separation pad (all models).....	59
Printer main input tray (all models).....	60
HP LaserJet 3015 ADF pickup roller .....	61
HP LaserJet 3015 ADF separation pad set.....	62
HP LaserJet 3015 ADF input tray.....	62
HP LaserJet 3015 ADF output bin.....	63
HP LaserJet 3020 and 3030 ADF pickup roller.....	63
HP LaserJet 3020 and 3030 ADF separation pad.....	66
HP LaserJet 3020 and 3030 control-panel bezel.....	66

### 4 Operational overview

Basic functions (all models) .....	70
Basic sequence of operation .....	71
Formatter system .....	75
Central processing unit .....	75
Line interface unit (HP LaserJet 3015 and 3030 only) .....	75
Standard boot process .....	75
RAM .....	76
Parallel interface or universal serial bus (USB) interface .....	76
Control panel .....	76
EconoMode .....	76
MEt .....	77
Enhanced I/O .....	77

PJL overview .....	77
Printer functions (all models).....	78
Engine control system (engine control unit and power-supply assembly).....	78
Image-formation system.....	83
Print cartridge.....	84
Printer paper-feed system.....	84
Jam detection in the printer .....	85
HP LaserJet 3015 all-in-one unique components.....	87
Basic operation.....	87
HP LaserJet 3020 and 3030 all-in-one unique components.....	93
Scanner and ADF functions and operation .....	93
Fax functions and operation (HP LaserJet 3015 and 3030 only) .....	96
PSTN operation .....	96
The fax subsystem .....	96
Formatter in the fax subsystem .....	96
LIU in the fax subsystem .....	96
Fax page storage in flash memory .....	99

## 5 Removal and replacement

Removal and replacement strategy.....	103
Required tools.....	103
Before performing service.....	103
After performing service.....	104
Parts removal order.....	104
HP LaserJet 3015 all-in-one.....	107
Link assemblies and scanner support frame springs.....	107
Scanner side covers.....	110
Separation-pad set.....	111
Control-panel bezel.....	112
Control-panel assembly.....	113
Media lever and media lever torsion spring.....	114
Separation pad assembly.....	115
Scanner assembly.....	118
Scanner assembly top cover.....	126
Top-cover assembly.....	129
Pickup roller .....	130
White platen.....	131
HP LaserJet 3020 and 3030 all-in-one.....	133
ADF input tray.....	133
Flatbed lid.....	134
Link assemblies and scanner support frame springs.....	136
Control-panel bezel.....	139
Control-panel assembly.....	139
ADF separation pad .....	140
ADF input-tray flag.....	141
ADF pickup roller .....	142
ADF scanner glass.....	143
Scanner assembly.....	145
Printer (product base).....	153
Printer separation pad.....	154
Print cartridge.....	154
Printer pickup roller.....	156
Media input tray.....	158
Transfer roller.....	159
Printer side covers.....	161

Print-cartridge door.....	163
Rear cover and fuser cover.....	164
Front cover.....	165
Installing the scanner cushions.....	167
Speaker assembly.....	168
Power supply.....	169
Formatter and line interface unit (LIU).....	171
Scanner support frame .....	175
Engine controller unit.....	177
Laser/scanner assembly.....	181
Main motor.....	182
Fuser.....	184
Paper-pickup assembly.....	186

## 6 Troubleshooting

Basic troubleshooting .....	188
Control-panel messages .....	193
Alert and warning messages .....	193
Critical error messages .....	201
Event-log codes.....	204
Solving image-quality problems .....	206
Checking the print cartridge .....	206
Solving print image-quality problems .....	206
Solving scanning (copying) image-quality problems .....	216
Repetitive image defect ruler .....	222
Solving paper-feed problems .....	223
Jams occur in the printer.....	223
Solving print paper-feed problems .....	225
Jams occur in the automatic document feeder (ADF).....	227
Solving scanner (copier) paper-feed problems .....	229
Solving problems with digital subscriber line (DSL) connections.....	231
Connecting additional devices.....	231
Functional checks .....	235
Control-panel test.....	235
Half self-test functional check .....	235
Drum rotation functional check .....	237
High-voltage contacts check .....	238
Updating the firmware code.....	240
Troubleshooting tools .....	241
Printing a configuration report, demonstration page, or menu structure .....	241
Printing all fax reports at once (HP LaserJet 3015 and 3030 only) .....	241
T.30 protocol trace (HP LaserJet 3015 and 3030 only) .....	241
Service-mode functions .....	262
Secondary service menu .....	262
Developer's menu .....	263
Adjusting the country/region code parameters.....	264
Soft reset.....	265
NVRAM init .....	265
System settings for localized products.....	266
Printer job language (PJL) software commands .....	268
Main wiring .....	269
Component locations, HP LaserJet 3015 all-in-one .....	272
Component locations, HP LaserJet 3020 and 3030 all-in-one.....	276
Component locations, HP LaserJet 3015, 3020 and 3030 printer (product base).....	277

## 7 Parts and diagrams

Ordering parts and supplies .....	282
Parts that wear .....	282
Parts .....	282
World-wide customer support .....	282
Accessories .....	284
Common hardware .....	284
How to use the parts lists and diagrams .....	285
HP LaserJet 3015 scanner assembly .....	286
HP LaserJet 3020/3030 scanner assembly .....	296
HP LaserJet 3015/3020/3030 printer base.....	304
Alphabetical parts list.....	320
Numerical parts list.....	326

## Index



# List of tables

Table 1-1.	Physical specifications.....	8
Table 1-2.	Environmental specifications (all models).....	8
Table 1-3.	HP LaserJet 3015 performance specifications.....	8
Table 1-4.	HP LaserJet 3020/3030 performance specifications.....	10
Table 1-5.	Electrical specifications (all models).....	12
Table 1-6.	Acoustic emissions (all models).....	12
Table 1-7.	Skew specifications (all models) .....	12
Table 1-8.	HP LaserJet 3030 fax capabilities.....	13
Table 1-9.	HP LaserJet 3015, 3020, and 3030 all-in-one battery.....	14
Table 2-1.	Control-panel menu structure.....	33
Table 2-2.	Supported media types.....	37
Table 3-1.	Life expectancies of parts that wear .....	48
Table 4-1.	HP LaserJet 3015 basic sequence of operation.....	71
Table 4-2.	HP LaserJet 3020 and 3030 basic sequence of operation.....	71
Table 4-3.	HP LaserJet 3015, 3020 and 3030 printer (product base) basic sequence of operation.....	73
Table 4-4.	Product startup messages.....	76
Table 4-5.	Dc power distribution.....	80
Table 6-1.	Alert and warning messages .....	193
Table 6-2.	Critical error messages.....	201
Table 6-3.	Event-log codes.....	204
Table 6-4.	Fax receive codes.....	243
Table 6-5.	Fax send codes.....	248
Table 6-6.	Fax phase sequence (HP LaserJet 3015 and 3030 only).....	254
Table 6-7.	Appropriate responses (HP LaserJet 3015 and 3030 only).....	256
Table 6-8.	Fax abbreviations (HP LaserJet 3015 and 3030 only).....	257
Table 6-9.	System settings.....	266
Table 7-1.	Technical support websites and related documentation.....	282
Table 7-2.	Accessories.....	284
Table 7-3.	Common fasteners .....	284
Table 7-4.	Alphabetical parts list.....	320
Table 7-5.	Numerical parts list.....	326





# List of figures

Figure 1-1.	HP LaserJet 3015, 3020, and 3030 all-in-one products.....	2
Figure 1-2.	HP LaserJet 3015 all-in-one hardware components.....	5
Figure 1-3.	HP LaserJet 3020 all-in-one hardware components.....	6
Figure 1-4.	HP LaserJet 3030 all-in-one hardware components.....	6
Figure 1-5.	Sample Identification label (on the back of the product).....	7
Figure 1-6.	Location of additional serial number label.....	7
Figure 2-1.	HP LaserJet 3015 dimensions.....	30
Figure 2-2.	HP LaserJet 3020/3030 dimensions.....	30
Figure 2-3.	HP LaserJet 3015 all-in-one control panel.....	31
Figure 2-4.	HP LaserJet 3020 all-in-one control panel.....	32
Figure 2-5.	HP LaserJet 3030 all-in-one control panel.....	32
Figure 2-6.	Envelope construction.....	41
Figure 2-7.	Loading the LJ 3015 ADF (1 of 3).....	44
Figure 2-8.	Loading the LJ 3015 ADF (2 of 3).....	45
Figure 2-9.	Loading the LJ 3015 ADF (3 of 3).....	45
Figure 2-10.	Loading the LJ 3020 and 3030 ADF (1 of 2).....	46
Figure 2-11.	Loading the LJ 3020 and 3030 ADF (2 of 2).....	46
Figure 2-12.	Loading the LJ 3020 and 3030 flatbed scanner.....	46
Figure 3-1.	Cleaning the LJ 3015 glass.....	51
Figure 3-2.	Cleaning the LJ 3015 white platen.....	51
Figure 3-3.	Cleaning the LJ 3020 and 3030 glass (1 of 2).....	52
Figure 3-4.	Cleaning the LJ 3020 and 3030 glass (2 of 2).....	52
Figure 3-5.	Cleaning the LJ 3020 and 3030 lid backing.....	52
Figure 3-6.	Cleaning the print-cartridge area (1 of 3).....	54
Figure 3-7.	Cleaning the print-cartridge area (2 of 3).....	54
Figure 3-8.	Cleaning the print-cartridge area (3 of 3).....	55
Figure 3-9.	Cleaning the separation pad.....	55
Figure 3-10.	Cleaning the pickup roller (1 of 3).....	55
Figure 3-11.	Cleaning the pickup roller (2 of 3).....	56
Figure 3-12.	Cleaning the pickup roller (3 of 3).....	56
Figure 3-13.	Cleaning the separation pad (1 of 2).....	56
Figure 3-14.	Cleaning the separation pad (2 of 2).....	56
Figure 3-15.	Replacing the pickup roller (1 of 7).....	57
Figure 3-16.	Replacing the pickup roller (2 of 7).....	57
Figure 3-17.	Replacing the pickup roller (3 of 7).....	57
Figure 3-18.	Replacing the pickup roller (4 of 7).....	58
Figure 3-19.	Replacing the pickup roller (5 of 7).....	58
Figure 3-20.	Replacing the pickup roller (6 of 7).....	58
Figure 3-21.	Replacing the pickup roller (7 of 7).....	58
Figure 3-22.	Replacing the printer separation pad (1 of 5).....	59
Figure 3-23.	Replacing the printer separation pad (2 of 5).....	59
Figure 3-24.	Replacing the printer separation pad (3 of 5).....	60
Figure 3-25.	Replacing the printer separation pad (4 of 5).....	60
Figure 3-26.	Replacing the printer separation pad (5 of 5).....	60
Figure 3-27.	Remove the media input tray (1 of 2).....	61
Figure 3-28.	Remove the paper pickup tray (2 of 2).....	61

Figure 3-29.	Remove the separation pad.....	62
Figure 3-30.	Replacing the ADF input tray.....	63
Figure 3-31.	Replacing the ADF output bin.....	63
Figure 3-32.	Replacing the ADF pickup-roller assembly (1 of 9) .....	63
Figure 3-33.	Replacing the ADF pickup-roller assembly (2 of 9) .....	64
Figure 3-34.	Replacing the ADF pickup-roller assembly (3 of 9) .....	64
Figure 3-35.	Replacing the ADF pickup-roller assembly (4 of 9) .....	64
Figure 3-36.	Replacing the ADF pickup-roller assembly (5 of 9) .....	64
Figure 3-37.	Replacing the ADF pickup-roller assembly (6 of 9) .....	65
Figure 3-38.	Replacing the ADF pickup-roller assembly (7 of 9) .....	65
Figure 3-39.	Replacing the ADF pickup-roller assembly (8 of 9) .....	65
Figure 3-40.	Replacing the ADF pickup-roller assembly (9 of 9) .....	65
Figure 3-41.	Remove the separation pad.....	66
Figure 3-42.	Replacing the control-panel bezel (1 of 4).....	66
Figure 3-43.	Replacing the control-panel bezel (2 of 4).....	67
Figure 3-44.	Replacing the control-panel bezel (3 of 4).....	67
Figure 3-45.	Replacing the control-panel bezel (4 of 4).....	67
Figure 4-1.	Product configuration .....	70
Figure 4-2.	HP LaserJet 3015, 3020, and 3030 printer (product base) timing diagram .....	74
Figure 4-3.	Printer functional block diagram.....	78
Figure 4-4.	Laser/scanner operation.....	80
Figure 4-5.	High-voltage power supply circuit.....	82
Figure 4-6.	Image-formation block diagram .....	83
Figure 4-7.	Printer paper path .....	85
Figure 4-8.	Basic operation block diagram.....	87
Figure 4-9.	HP LaserJet 3015 optical and feed systems.....	88
Figure 4-10.	HP LaserJet 3015 feed control (1 of 2).....	89
Figure 4-11.	HP LaserJet 3015 feed control (2 of 2).....	90
Figure 4-12.	HP LaserJet 3015 optical system (1 of 2).....	91
Figure 4-13.	HP LaserJet 3015 optical system (2 of 2).....	92
Figure 4-14.	HP LaserJet 3020 and 3030 optical system .....	93
Figure 4-15.	HP LaserJet 3020 and 3030 ADF path .....	95
Figure 5-1.	HP LaserJet 3015, 3020, and 3030 products.....	104
Figure 5-2.	Parts removal order for the HP LaserJet 3015 all-in-one.....	105
Figure 5-3.	Parts removal order for the HP LaserJet 3020 and 3030 all-in-one .....	105
Figure 5-4.	Parts removal order for the printer (product base, all models).....	106
Figure 5-5.	Parts removal order HP LaserJet 3015 scanner assembly.....	107
Figure 5-6.	Remove the link assemblies and scanner support frame springs (1 of 4) ....	108
Figure 5-7.	Remove the link assemblies and scanner support frame springs (2 of 4).....	108
Figure 5-8.	Remove the link assemblies and scanner support frame springs (3 of 4).....	109
Figure 5-9.	Remove the link assemblies and scanner support frame springs (4 of 4).....	109
Figure 5-10.	Remove the scanner side covers (1 of 3).....	110
Figure 5-11.	Remove the scanner side covers (2 of 3).....	110
Figure 5-12.	Remove the scanner side covers (3 of 3).....	111
Figure 5-13.	Remove the separation pad.....	112
Figure 5-14.	Remove the control-panel bezel (1 of 3).....	112
Figure 5-15.	Remove the control-panel bezel (2 of 3).....	113
Figure 5-16.	Remove the control-panel bezel (3 of 3).....	113
Figure 5-17.	Remove the control-panel assembly (1 of 2).....	114
Figure 5-18.	Remove the control-panel assembly (2 of 2).....	114
Figure 5-19.	Remove the media lever and media lever torsion spring (1 of 2).....	115
Figure 5-20.	Remove the media lever and media lever torsion spring (2 of 2).....	115
Figure 5-21.	Remove the separation pad assembly (1 of 3).....	116
Figure 5-22.	Remove the separation pad assembly (2 of 3).....	117
Figure 5-23.	Remove the separation pad assembly (3 of 3).....	117

Figure 5-24.	Remove the scanner assembly (1 of 15).....	118
Figure 5-25.	Remove the scanner assembly (2 of 15).....	118
Figure 5-26.	Remove the scanner assembly (3 of 15).....	119
Figure 5-27.	Remove the scanner assembly (4 of 15).....	119
Figure 5-28.	Remove the scanner assembly (5 of 15).....	120
Figure 5-29.	Remove the scanner assembly (6 of 15).....	120
Figure 5-30.	Remove the scanner assembly (7 of 15).....	121
Figure 5-31.	Remove the scanner assembly (8 of 15).....	121
Figure 5-32.	Remove the scanner assembly (9 of 15).....	122
Figure 5-33.	Remove the scanner assembly (10 of 15).....	122
Figure 5-34.	Remove the scanner assembly (11 of 15).....	123
Figure 5-35.	Remove the scanner assembly (12 of 15).....	124
Figure 5-36.	Remove the scanner assembly (13 of 15).....	125
Figure 5-37.	Remove the scanner assembly (14 of 15).....	125
Figure 5-38.	Remove the scanner assembly (15 of 15).....	126
Figure 5-39.	Remove the scanner assembly top cover (1 of 4).....	127
Figure 5-40.	Remove the scanner assembly top cover (2 of 4).....	127
Figure 5-41.	Remove the scanner assembly top cover (3 of 4).....	128
Figure 5-42.	Remove the scanner assembly top cover (4 of 4).....	128
Figure 5-43.	Reinstalling the scanner assembly top cover.....	129
Figure 5-44.	Align the scanner assembly top cover and base.....	129
Figure 5-45.	Remove the top-cover assembly (1 of 2).....	130
Figure 5-46.	Remove the top-cover assembly (2 of 2).....	130
Figure 5-47.	Remove the pickup roller (1 of 2).....	131
Figure 5-48.	Remove the pickup roller (2 of 2).....	131
Figure 5-49.	Remove the white platen (1 of 2).....	132
Figure 5-50.	Remove the white platen (2 of 2).....	132
Figure 5-51.	Parts removal order HP LaserJet 3020 and 3030 scanner assembly.....	133
Figure 5-52.	Remove the ADF input tray.....	133
Figure 5-53.	Remove the flatbed lid (1 of 5).....	134
Figure 5-54.	ADF cover correctly installed.....	134
Figure 5-55.	Remove the flatbed lid (2 of 5).....	135
Figure 5-56.	Remove the flatbed lid (3 of 5).....	135
Figure 5-57.	Remove the flatbed lid (4 of 5).....	136
Figure 5-58.	Remove the flatbed lid (5 of 5).....	136
Figure 5-59.	Remove the link assemblies and scanner support frame springs (1 of 4).....	137
Figure 5-60.	Remove the link assemblies and scanner support frame springs (2 of 4).....	137
Figure 5-61.	Remove the link assemblies and scanner support frame springs (3 of 4).....	138
Figure 5-62.	Remove the link assemblies and scanner support frame springs (4 of 4).....	138
Figure 5-63.	Remove the control-panel bezel.....	139
Figure 5-64.	Remove the control panel assembly (1 of 2).....	139
Figure 5-65.	Remove the control panel assembly (2 of 2).....	140
Figure 5-66.	Remove the separation pad.....	140
Figure 5-67.	Remove the ADF input-tray flag.....	141
Figure 5-68.	Correct positioning of the ADF input-tray spring.....	141
Figure 5-69.	Remove the ADF pickup roller (1 of 2).....	142
Figure 5-70.	Remove the ADF pickup roller (2 of 2).....	142
Figure 5-71.	Remove the ADF scanner glass (1 of 3).....	143
Figure 5-72.	Remove the ADF scanner glass (2 of 3).....	143
Figure 5-73.	Remove the ADF scanner glass (3 of 3).....	144
Figure 5-74.	Install the ADF scanner glass.....	144
Figure 5-75.	Remove the scanner assembly (1 of 13).....	145
Figure 5-76.	Remove the scanner assembly (2 of 13).....	145
Figure 5-77.	Remove the scanner assembly (3 of 13).....	146
Figure 5-78.	Remove the scanner assembly (4 of 13).....	146
Figure 5-79.	Remove the scanner assembly (5 of 13).....	147

Figure 5-80.	Remove the scanner assembly (6 of 13).....	147
Figure 5-81.	Remove the scanner assembly (7 of 13).....	148
Figure 5-82.	Remove the scanner assembly (8 of 13).....	148
Figure 5-83.	Remove the scanner assembly (9 of 13).....	149
Figure 5-84.	Remove the scanner assembly (10 of 13) .....	150
Figure 5-85.	Remove the scanner assembly (11 of 13) .....	151
Figure 5-86.	Remove the scanner assembly (12 of 13).....	151
Figure 5-87.	Remove the scanner assembly (13 of 13).....	152
Figure 5-88.	Parts removal order for the printer (product base, all models).....	153
Figure 5-89.	Remove the printer separation pad (1 of 2).....	154
Figure 5-90.	Remove the printer separation pad (2 of 2).....	154
Figure 5-91.	Remove the print cartridge (1 of 2).....	155
Figure 5-92.	Remove the print cartridge (2 of 2).....	155
Figure 5-93.	Remove the printer pickup roller (1 of 5).....	156
Figure 5-94.	Remove the printer pickup roller (2 of 5).....	156
Figure 5-95.	Remove the printer pickup roller (3 of 5).....	157
Figure 5-96.	Remove the printer pickup roller (4 of 5).....	157
Figure 5-97.	Remove the printer pickup roller (5 of 5).....	158
Figure 5-98.	Remove the media input tray (1 of 3).....	158
Figure 5-99.	Remove the media input tray (2 of 3).....	159
Figure 5-100.	Remove the media input tray (3 of 3).....	159
Figure 5-101.	Remove the transfer roller (1 of 3).....	160
Figure 5-102.	Remove the transfer roller (2 of 3).....	160
Figure 5-103.	Remove the transfer roller (3 of 3).....	161
Figure 5-104.	Remove the printer side covers (1 of 3).....	161
Figure 5-105.	Remove the printer side covers (2 of 3) .....	162
Figure 5-106.	Remove the printer side covers (2 of 3) .....	162
Figure 5-107.	Remove the printer side covers (3 of 3).....	163
Figure 5-108.	Remove the print-cartridge door (1 of 2).....	163
Figure 5-109.	Remove the print-cartridge door (2 of 2).....	164
Figure 5-110.	Remove the rear cover and fuser cover (1 of 3).....	164
Figure 5-111.	Remove the rear cover and fuser cover (2 of 3).....	165
Figure 5-112.	Remove the rear cover and fuser cover (3 of 3).....	165
Figure 5-113.	Remove the front cover (1 of 3).....	166
Figure 5-114.	Remove the front cover (2 of 3).....	166
Figure 5-115.	Remove the front cover (3 of 3).....	167
Figure 5-116.	Front-cover locking tabs.....	167
Figure 5-117.	Installing the scanner cushions.....	168
Figure 5-118.	Remove the speaker assembly (1 of 2).....	168
Figure 5-119.	Remove the speaker assembly (2 of 2).....	169
Figure 5-120.	Remove the power supply (1 of 3).....	170
Figure 5-121.	Remove the power supply (2 of 3).....	170
Figure 5-122.	Remove the power supply (3 of 3).....	171
Figure 5-123.	Correct routing of the power-supply wire-harnesses.....	171
Figure 5-124.	HP LaserJet 3015 formatter and LIU.....	173
Figure 5-125.	HP LaserJet 3020 formatter without LIU.....	173
Figure 5-126.	HP LaserJet 3030 formatter and LIU.....	173
Figure 5-127.	Remove the formatter (1 of 2) (and LIU installed).....	174
Figure 5-128.	Remove the formatter (2 of 2).....	174
Figure 5-129.	Remove the scanner support frame (1 of 3).....	175
Figure 5-130.	Remove the scanner support frame (2 of 3).....	176
Figure 5-131.	Remove the scanner support frame (3 of 3).....	176
Figure 5-132.	Remove the chassis reinforcement plate.....	177
Figure 5-133.	Remove the ECU (1 of 6).....	178
Figure 5-134.	Remove the ECU (2 of 6).....	178
Figure 5-135.	Remove the ECU (3 of 6).....	179

Figure 5-136. Remove the ECU (4 of 6).....	179
Figure 5-137. Remove the ECU (5 of 6).....	180
Figure 5-138. Remove the ECU (6 of 6).....	180
Figure 5-139. Laser/scanner assembly shutter arm.....	181
Figure 5-140. Remove the laser/scanner assembly.....	182
Figure 5-141. Remove the main motor (1 of 2).....	183
Figure 5-142. Remove the main motor (2 of 2).....	183
Figure 5-143. Remove the fuser assembly (1 of 2).....	184
Figure 5-144. Remove the fuser assembly (2 of 2).....	185
Figure 5-145. Fragile tab on fuser assembly.....	185
Figure 5-146. Remove the paper-pickup assembly.....	186
Figure 6-1. Repetitive image defect ruler.....	222
Figure 6-2. Clear a jam in the product base (1 of 3).....	223
Figure 6-3. Clear a jam in the product base (2 of 3).....	224
Figure 6-4. Clear a jam in the product base (3 of 3).....	224
Figure 6-5. Clearing output bin jams (HP LJ 3015).....	225
Figure 6-6. Clearing ADF output bin jams (HP LaserJet 3015).....	225
Figure 6-7. Clearing output bin jams (HP LaserJet 3020 and 3030).....	225
Figure 6-8. ADF lid open (HP LaserJet 3015).....	228
Figure 6-9. ADF lid open (HP LaserJet 3020 and 3030).....	228
Figure 6-10. Clear an ADF jam (HP LaserJet 3015).....	229
Figure 6-11. Clear an ADF jam (HP LaserJet 3020 and 3030; 1 of 2).....	229
Figure 6-12. Clear an ADF jam (HP LaserJet 3020 and 3030; 2 of 2).....	229
Figure 6-13. Check the fuser connectors on the fuser.....	237
Figure 6-14. Check the fuser connectors on the power supply.....	237
Figure 6-15. Print-cartridge high-voltage contacts.....	238
Figure 6-16. High-voltage contacts.....	239
Figure 6-17. Example of a T.30 trace of a successfully sent fax.....	260
Figure 6-18. Example of a T.30 trace of a successfully received fax.....	261
Figure 6-19. Main wiring, HP LaserJet 3015 scanner assembly.....	269
Figure 6-20. Main wiring, HP LaserJet 3020 and 3030 scanner assembly.....	270
Figure 6-21. Main wiring, HP LaserJet 3015, 3020, and 3030 product base.....	271
Figure 6-22. Major components.....	272
Figure 6-23. Main parts.....	273
Figure 6-24. Sensors and motors.....	274
Figure 6-25. PCBs.....	275
Figure 6-26. HP LaserJet 3020 and 3030 components.....	276
Figure 6-27. Major components.....	277
Figure 6-28. Solenoid, sensors, switches, and motor.....	278
Figure 6-29. PCBs.....	279
Figure 7-1. HP LaserJet 3015.....	286
Figure 7-2. ADF input and delivery assemblies (HP LaserJet 3015).....	288
Figure 7-3. Internal components (HP LaserJet 3015).....	290
Figure 7-4. Frame assembly (HP LaserJet 3015).....	292
Figure 7-5. Guide assembly (HP LaserJet 3015).....	294
Figure 7-6. HP LaserJet 3020/3030 scanner assembly.....	296
Figure 7-7. Link assembly (HP LaserJet 3020/3030).....	298
Figure 7-8. Major assemblies (HP LaserJet 3020/3030).....	300
Figure 7-9. HP LaserJet 3015/3020/3030 printer base.....	304
Figure 7-10. Pickup and delivery tray assemblies (LJ 3015/3020/3030 printer base).....	306
Figure 7-11. External covers (LJ 3015/3020/3030 printer base).....	308
Figure 7-12. Internal components 1 of 1 (LJ 3015/3020/3030 printer base).....	310
Figure 7-13. Internal components 2 of 2 (LJ 3015/3020/3030 printer base).....	312
Figure 7-14. Internal components 3 of 3 (LJ 3015/3020/3030 printer base).....	314
Figure 7-15. Paper-pickup assembly (LJ 3015/3020/3030 printer base).....	316
Figure 7-16. Fuser (fixing assy) assembly (LJ 3015/3020/3030 printer base).....	318



# 1

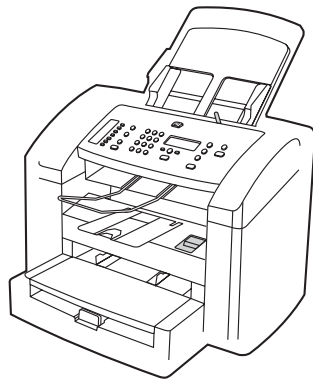
# Product Information

This chapter provides information about the following topics.

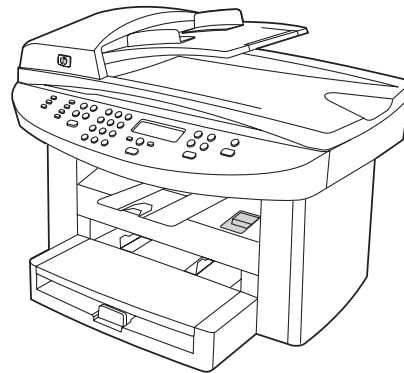
Product configurations.....	2
HP LaserJet 3015, 3020, and 3030 all-in-one products.....	2
HP LaserJet 3015 all-in-one product.....	3
HP LaserJet 3020/3030 all-in-one product.....	3
Product features .....	4
Overview of products.....	5
Hardware components.....	5
Product identification.....	7
Model and serial numbers.....	7
Product specifications.....	8
Physical specifications.....	8
Environmental specifications (all models).....	8
HP LaserJet 3015 performance specifications.....	8
HP LaserJet 3020/3030 performance specifications.....	10
Electrical specifications (all models).....	12
Acoustic emissions (all models).....	12
Skew specifications (all models).....	12
HP LaserJet 3030 fax capabilities.....	13
HP LaserJet 3015, 3020, and 3030 all-in-one battery.....	14
Warranty statement.....	15
HP's Premium Protection print-cartridge warranty.....	16
Extended warranty.....	17
Print-cartridge information .....	18
Refilled print cartridges .....	18
HP LaserJet printing supplies .....	18
HP Printing Supplies Returns and Recycling Program information.....	18
FCC regulations.....	20
Telephone Consumer Protection Act (United States).....	22
IC CS-03 requirements.....	23
Declaration of Conformity .....	24
Safety statements.....	25
Laser safety statement.....	25
Canada DOC regulations.....	25
Laser statement for Finland.....	26
Korean EMI statement.....	26
Australian EMC requirements.....	26
Regulatory information for the European Union countries/regions .....	27

## Product configurations

### HP LaserJet 3015, 3020, and 3030 all-in-one products



HP LaserJet 3015



HP LaserJet 3020 and 3030

Figure 1-1.

#### HP LaserJet 3015, 3020, and 3030 all-in-one products

- Prints up to 15 pages per minute (less than a 10-second wait for the first page to print)
- 150-sheet printer input tray with a 10-page priority input tray
- 600 by 600 dpi printing using Resolution Enhancement technology (REt)
- 2,000-page print cartridge (using an average of 5 percent toner coverage on printed A4- or letter-size pages)
- 4 MB of ROM, 32 MB of RAM
- Universal serial bus (USB) port
- 1284-B compliant parallel port
- V.34 fax modem that supports speeds up to 33.6 kbps (HP LaserJet 3015 and 3030 only)
- Two RJ-11 ports (one line and one accessory port)
- Two-line LCD display (16 characters per line)
- Additional 2 MB flash ROM for fax storage (up to 110 pages based on a slerexe test page) (HP LaserJet 3015 and 3030 only)
- Expandable input/output (I/O) using the HP Jetdirect 10/100Base-TX
- Individual speed-dial memory and group speed-dial memory (120 entries using the Toolbox) (HP LaserJet 3015 and 3030 only)



- Supported software
  - HP Toolbox
  - HP LaserJet Scan
  - TWAIN or WIA Scan Driver
  - HP LaserJet Fax
  - Readiris OCR (not installed with other software; separate installation is required)
  - Printer drivers (PCL 5e, PCL 6, and PS)
  - Installer/uninstaller
- Supported operating systems
  - Windows 98Se (second edition)
  - Windows Millennium Edition (Me)
  - Windows 2000
  - Windows XP (32-bit)
  - Mac OS 9.1 or 9.2.x
  - Mac OS X (10.2.x only)

---

**Note**

---

Driver-only support for Windows 98 (first edition), Windows XP 64-bit, and Windows 2003 Server.

## HP LaserJet 3015 all-in-one product

- Contact image scanner (CIS) 600 ppi, 24-bit color scanner
- 30-sheet automatic document feeder (ADF) feeds pages at up to 12 pages per minute (ppm)
- Three status LEDs, a numeric keypad, and menu navigation buttons on the control panel
- Selectable single- or multiple-sheet lever for the ADF

## HP LaserJet 3020/3030 all-in-one product

- Coupled charged device (CCD) 600 ppi 24-bit color scanner
- Letter/A4-sized flatbed scanner glass
- 50-sheet automatic document feeder (ADF) feeds pages at up to 12 pages per minute (ppm)
- Status LEDs, a numeric keypad, and menu navigation buttons on the control panel (the HP LaserJet 3020 has two status LEDs; the HP LaserJet 3030 has three status LEDs)

---

**Note**

---

The HP LaserJet 3020 does *not* have fax capabilities.

## Product features

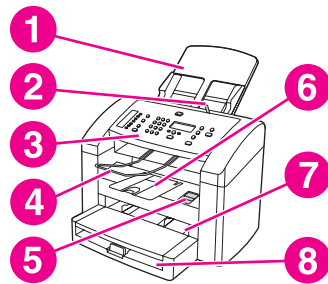
The HP LaserJet 3015, 3020, and 3030 all-in-one products are designed to perform the following tasks:

- **Print:** Print documents with HP LaserJet quality.
- **Copy:** Make up to 99 laser-quality copies of a 50-page original. It also enlarges, reduces, and lightens/darkens copies. (The HP LaserJet 3020 and 3030 also collate copies.)
- **Scan:** Scan documents to create electronic text or graphics files.
- **Fax:** Send and receive documents by using standard fax communications (HP LaserJet 3015 and 3030 only).

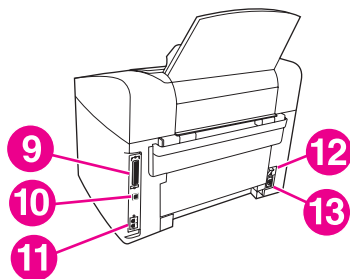
# Overview of products

## Hardware components

Use the following illustrations to identify the hardware components.

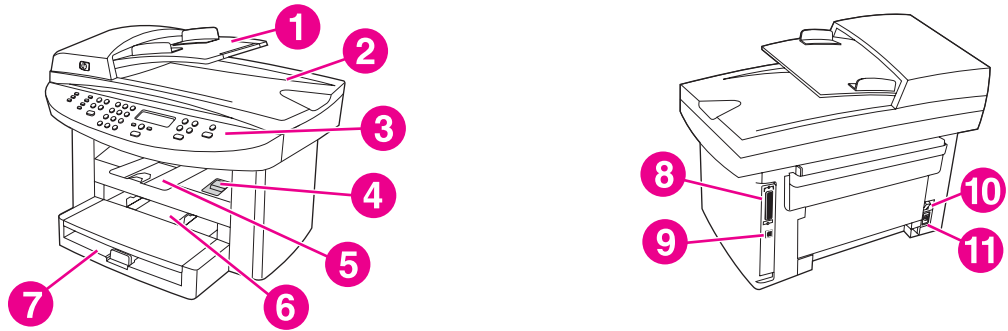


**Figure 1-2.** HP LaserJet 3015 all-in-one hardware components (1 of 2)



**Figure 1-2.** HP LaserJet 3015 all-in-one hardware components (2 of 2)

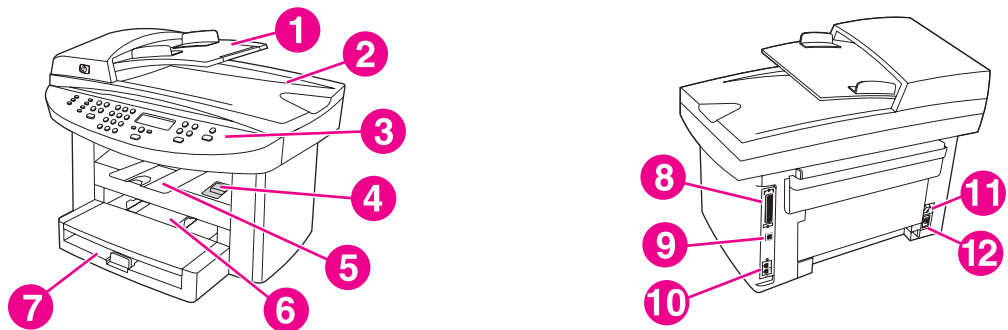
- 1 Automatic document feeder (ADF) input tray
- 2 ADF media lever
- 3 Control panel
- 4 ADF output bin
- 5 Print-cartridge-door release
- 6 Output bin
- 7 Priority input slot
- 8 Media input tray
- 9 Parallel port
- 10 USB port
- 11 Fax interface ports
- 12 Power switch
- 13 Power receptacle



**Figure 1-3.**

**HP LaserJet 3020 all-in-one hardware components**

- 1 Automatic document feeder (ADF) input tray
- 2 Flatbed scanner lid and ADF output bin
- 3 Control panel
- 4 Print-cartridge-door release
- 5 Output bin
- 6 Priority input tray
- 7 Media input tray
- 8 Parallel port
- 9 USB port
- 10 Power switch
- 11 Power receptacle



**Figure 1-4.**

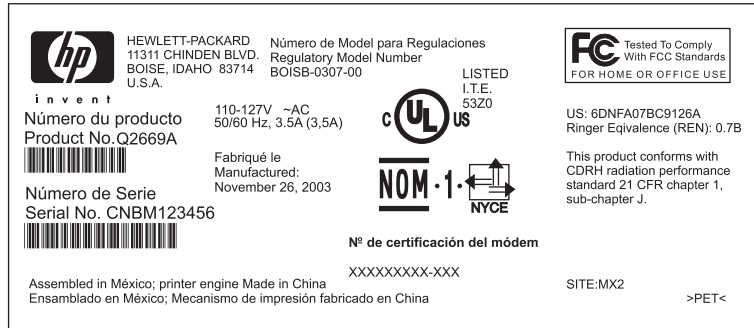
**HP LaserJet 3030 all-in-one hardware components**

- 1 Automatic document feeder (ADF) input tray
- 2 Flatbed scanner lid and ADF output bin
- 3 Control panel
- 4 Print-cartridge-door release
- 5 Output bin
- 6 Priority input tray
- 7 Media input tray
- 8 Parallel port
- 9 USB port
- 10 Fax interface ports
- 11 Power switch
- 12 Power receptacle

# Product identification

## Model and serial numbers

An identification label is located on the back of the product. This label contains the model and serial numbers. The serial number contains information about the country/region of origin, revision level, production code, and production number of the product. The label also contains power-rating and regulatory information.



**Figure 1-5. Sample Identification label (on the back of the product)**

An additional identification label is located on the top-left side of the scanner support frame. Open the print cartridge door to find this label.

### Note

The additional serial number label is in the same location on the scanner support frame for all of the HP LaserJet 3015, 3020, and 3030 all-in-one products.



**Figure 1-6. Location of additional serial number label**

# Product specifications

## Physical specifications

**Table 1-1. Physical specifications**

Product	Height	Depth	Width	Weight
HP LaserJet 3015 product	445 mm (17.5 inches)	440 mm (17.3 inches)	430 mm (16.9 inches)	9.1 kg (20 pounds)
HP LaserJet 3020/3030 product	556 mm 21.89 inches)	483 mm (19.02 inches)	497 mm (19.6 inches)	11.34 kg (25 pounds)

## Environmental specifications (all models)

**Table 1-2. Environmental specifications (all models)**

Category	Specification
Operating environment (unit plugged into an ac outlet)	<ul style="list-style-type: none"><li>• Temperature: 15° to 32.5° C ( 59° to 90.5° F)</li><li>• Humidity: 10 percent to 80 percent relative humidity (no condensation)</li></ul>
Storage environment (unit not plugged into an ac outlet)	<ul style="list-style-type: none"><li>• Temperature: -20° to 40° C (-4° to 104° F)</li><li>• Humidity: Less than 95 percent relative humidity (with no condensation)</li></ul>

## HP LaserJet 3015 performance specifications

**Table 1-3. HP LaserJet 3015 performance specifications**

Category	Specification
<b>Printer capacities and ratings</b>	
Print speed	<ul style="list-style-type: none"><li>• 15 pages per minute (ppm) for letter size paper and 14 ppm for A4-size paper</li><li>• First page out in less than 10 seconds</li></ul>
Media input tray capacity	150 sheets of regular-weight 60-g/m <sup>2</sup> (16-lb) paper or up to 30 envelopes
Priority input slot capacity	10 sheets of regular-weight 75-g/m <sup>2</sup> (20-lb) paper or 1 envelope
Output bin capacity	Up to 125 sheets of regular-weight 16-lb (60-g/m <sup>2</sup> ) paper
Minimum paper size	76 by 127 mm (3 by 5 inches)

**Table 1-3. HP LaserJet 3015 performance specifications (continued)**

<b>Category</b>	<b>Specification</b>
Maximum paper size	216 by 356 mm (8.5 by 14 inches). The output bin holds one sheet of legal-size media 215 by 356 mm (8.5 by 14 inches). Subsequent sheets of legal-size media slide off of the output bin.
Media weight	Media input tray: 60- to 163-g/m <sup>2</sup> (16- to 43-lb) cut sheet paper Priority input slot: 60- to 90-g/m <sup>2</sup> (16- to 24-lb) single thickness envelopes Print paper output: 135- to 176-g/m <sup>2</sup> (36- to 47-lb) postcards
Base memory	4 MB of ROM and 32 MB of RAM (9 MB for the product and 23 MB available to the user)
Print resolution	1,200 dpi
Duty cycle	<ul style="list-style-type: none"> <li>● 7,000 single-sided pages per month (maximum)</li> <li>● 800 single-sided pages per month (average)</li> </ul>
PCL (Printer Control Language)	Level 5e and 6
PostScript® (PS)	Emulates Adobe® PostScript level 2
<b>Copier capacities and ratings</b>	
Copy speed	Up to 15 ppm
Multiple copies	Up to 99 per job
Copy reduction or enlargement	25 percent to 400 percent
Acoustic emissions (per ISO 9296) while copying	6.3 Bel sound power level
<b>Scanner capacities and ratings</b>	
Margins for scanned items	3.05 mm (0.12 inch) right and left 4.23 mm (0.17 inch) top and bottom
Scanner duty cycle	2,000 single-sided items per month
Scan resolution	600 dpi color
<b>Automatic document feeder (ADF) input tray specifications</b>	
Input capacity	Up to 30 sheets of flat 60- to 75-g/m <sup>2</sup> (16- to 20-lb) media
Media weight (input and output)	Single sheet setting ( blue media lever set to the right): 42- to 260-g/m <sup>2</sup> (11- to 69-lb) Multiple sheet setting ( blue media lever set to the left): 46- to 105-g/m <sup>2</sup> (12- to 28-lb)
Media size	74 by 105 mm (2.9 by 4.1 inches) to 216 mm by 381 mm (8.5 by 15 inches). The ADF output bin holds one sheet of legal-size media 215 by 356 mm (8.5 by 14 inches). Subsequent sheets of legal-size media slide off of the ADF output bin.
Speed	Up to 12 ppm for letter-size or A4-size media
Duty cycle	1,000 pages per month
<b>Port availability</b>	

**Table 1-3. HP LaserJet 3015 performance specifications (continued)**

Category	Specification
USB	Compatible with USB 2.0 specification
Parallel	<ul style="list-style-type: none"> <li>• IEEE 1284-B level 2 device with an IEEE 1284-B receptacle</li> <li>• Set the host computer to ECP (enhanced capabilities mode)</li> </ul>
<b>Fax capabilities and ratings</b>	
Fax transmission speed	3 seconds per page (ITU-T Test Image #1)
Right/left margins for printed pages	6.3 mm (0.25 inch)
Top/bottom margins for printed pages	5.08 mm (0.2 inch)
Fax compatibility	ITU Group 3; ECM
Fax coding schemes	MH, MR, and MMR
Modem speed	Up to 33,600 bits per second (bps)
Speed dialing	Yes
Distinctive ring detect	Yes
Fax resolution (standard)	203 by 98 dpi
Fax resolution (fine)	203 by 196 dpi
Fax resolution (superfine)	300 by 300 dpi (no halftone)
Fax resolution (photo)	300 by 300 dpi (halftone enabled)
Fax page storage	Up to 110 slerexe pages

## HP LaserJet 3020/3030 performance specifications

**Table 1-4. HP LaserJet 3020/3030 performance specifications**

Category	Specification
<b>Printer capacities and ratings</b>	
Print speed	<ul style="list-style-type: none"> <li>• 15 pages per minute (ppm) for letter-size paper and 14 ppm for A4-size paper</li> <li>• First page out in less than 9 seconds</li> </ul>
Media input tray capacity	150 sheets of regular-weight 60-g/m <sup>2</sup> (16-lb) paper or up to 30 envelopes
Priority input tray capacity	10 sheets of regular-weight 75-g/m <sup>2</sup> (20-lb) paper or 1 envelope
Output bin capacity	Up to 125 sheets of regular-weight 75-g/m <sup>2</sup> (20-lb) paper
Minimum paper size	76 by 127 mm (3 by 5 inches)
Maximum paper size	216 by 356 mm (8.5 by 14 inches)



**Table 1-4. HP LaserJet 3020/3030 performance specifications (continued)**

Category	Specification
Media weight	Media input tray: 60- to 163-g/m <sup>2</sup> (16- to 43-lb) cut sheet paper Priority input slot: 60- to 90-g/m <sup>2</sup> (16- to 24-lb) single thickness envelopes Print paper output: 135- to 176-g/m <sup>2</sup> (36- to 47-lb) postcards
Base memory	4 MB of ROM and 32 MB of RAM (9 MB for the product and 23 MB available to the user)
Print resolution	1,200 dpi
Duty cycle	<ul style="list-style-type: none"> <li>● 7,000 single-sided pages per month (maximum)</li> <li>● 1,000 single-sided pages per month (average)</li> </ul>
PCL (Printer Control Language)	Level 5e and 6
PostScript (PS)	Emulates Adobe PostScript level 2
<b>Copier capacities and ratings</b>	
Copy speed	Up to 15 ppm
Multiple copies	Up to 99 per job
Copy reduction or enlargement	25 percent to 400 percent
Acoustic emissions (per ISO 9296) while copying	6.3 Bel sound power level
<b>Scanner capacities and ratings</b>	
Margins for scanned items	3.05 mm (0.12 inch) right and left 4.06 mm (0.16 inch) top and bottom
Media size	(216 by 356 mm) (8.5 by 11.7 inches) no minimum size
Scanner duty cycle	2,000 single-sided items per month
Scan resolution	600 dpi color
<b>Automatic document feeder (ADF) input tray specifications</b>	
Input capacity	Up to 50 sheets of flat 60 to 75-g/m <sup>2</sup> (16- to 20-lb) media
Media weight (input and output)	60- to 90-g/m <sup>2</sup> (16- to 24-lb)
Media size	127 by 127 mm (5 by 5 inches) to 216 by 381 mm (8.5 by 15 inches)
Speed	Up to 15 ppm for letter-size or A4-size media
Duty cycle	1,000 pages per month
<b>Port availability</b>	
USB	Compatible with USB 2.0 specification
Parallel	<ul style="list-style-type: none"> <li>● IEEE 1284-B level 2 device with an IEEE 1284-B receptacle</li> <li>● Set the host computer to ECP (enhanced capabilities mode)</li> </ul>

## Electrical specifications (all models)

### Note

The values are subject to change. See <http://www.hp.com/support/lj3015> or <http://www.hp.com/support/lj3030> for the most current information. The 110-volt and 220-volt power sources are not interchangeable.

**Table 1-5. Electrical specifications (all models)**

Item	110-volt models	220-volt models
Power supply	110 to 127 V ( $\pm 10\%$ ) 50 to 60 Hz ( $\pm 2$ Hz)	220 to 240 V ( $\pm 10\%$ ) 50 to 60 Hz ( $\pm 2$ Hz)
Power consumption (typical)	300 W (average)	300 W (average)
Printing	14 W (average)	14 W (average)
Standby	14 W (average)	14 W (average)
Power Save	0 W	0 W
Off		
Minimum recommended circuit capacity	4.5 A	2.3 A

## Acoustic emissions (all models)

### Note

The values are subject to change. See <http://www.hp.com/support/lj3015> or <http://www.hp.com/support/lj3030> for the most current information. During other operations, acoustic emissions can vary.

**Table 1-6. Acoustic emissions (all models)**

Activity level	Operator (<1m)	Bystander (1m)	Sound power
Active	LpAm56 dB (A)	LpAm48 dB (A)	LWAd6.1 Bels dB (A)
Idle	inaudible	inaudible	inaudible

## Skew specifications (all models)

**Table 1-7. Skew specifications (all models)**

Category	Specification
<b>Skew:</b> all vertical lines are parallel to the left edge of the media.	3.0 mm (0.12 inch) over 250 mm (9.85 inches) length (0.8 percent) for cut-sheet media (except for A5 size) 3.3 mm (.13 inch) over 220 mm (8.66 inches) length (1.5 percent) for envelopes, postcards, and A5 size cut-sheet media. 1.65 mm (0.06 inch) over 190 mm (7.48 inches) width for cut-sheet media (leading-edge skew)

**Table 1-7. Skew specifications (all models) (continued)**

Category	Specification
<b>First line/leading edge skew:</b> the distance of the first scan line from the leading edge of the media.	4.23 mm (0.16 inch) ± 2.0 mm (0.07 inch) for cut-sheet media. 4.23 mm (0.16 inch) ± 2.5 mm (0.09 inch) for thick media over 105-g/m <sup>2</sup> (28 pounds). 15.0 mm (0.59 inch) ± 3.5 mm (0.13 inch) for envelopes and postcards.
<b>Left margin:</b> the distance of the left-most vertical line (first two dots of each scan line) from the left edge of the media.	4.23 mm (0.16 inch) ± 2.0 mm (0.07 inch) for cut-sheet media. 15.0 mm (0.59 inch) ± 3.5 mm (0.13 inch) for envelopes and postcards.
<b>Parallelism</b>	All vertical lines must be parallel within an absolute value of 2 percent (1.5 mm [0.05 inch] over a 250 mm [9.85 inch] length for cut-sheet media).

## HP LaserJet 3030 fax capabilities

**Table 1-8. HP LaserJet 3030 fax capabilities**

Category	Specification
Fax transmission speed	3 seconds/page (ITU-T Test Image #1)
Right/left margins for printed pages	6.3 mm (0.25 inch)
Top/bottom margins for printed pages	5.08 mm (0.2 inch)
Fax compatibility	ITU Group 3; ECM
Fax coding schemes	MH, MR, and MMR
Modem speed	Up to 33,600 bits per second (bps)
Speed dialing	Yes
Distinctive ring detect	Yes
Fax resolution (standard)	203 by 98 dpi
Fax resolution (fine)	203 by 196 dpi
Fax resolution (superfine)	300 by 300 dpi (no halftone)
Fax resolution (photo)	300 by 300 dpi (halftone enabled)
Fax page storage	Up to 110 slerexe pages

## HP LaserJet 3015, 3020, and 3030 all-in-one battery

Table 1-9. HP LaserJet 3015, 3020, and 3030 all-in-one battery

Category	Specification
Battery material	Polycarbon Monoflouride Lithium
Battery type	Button or coin cell battery <hr/> <b>Note</b> The battery is permanently attached to the formatter and cannot be removed or replaced. <hr/>
Quantity per device	1
Weight	Approximately 1 gram (0.04 ounce)
Lithium type	Solid
Battery manufacturers	Rayovac of Madison, Wisconsin, USA; and Panasonic of Secaucus, New Jersey, USA

## Warranty statement

HP PRODUCT  
HP LaserJet 3015/3020/3030 printers

DURATION OF LIMITED WARRANTY  
One year from date of purchase

HP warrants to you, the end-user customer, that HP hardware, accessories, and supplies will be free from defects in materials and workmanship after the date of purchase, for the period specified above. If HP receives notice of such defects during the warranty period, HP will, at its option, either repair or replace products which prove to be defective. Replacement products may be either new or equivalent in performance to new.

HP warrants to you that HP software will not fail to execute its programming instructions after the date of purchase, for the period specified above, due to defects in material and workmanship when properly installed and used. If HP receives notice of such defects during the warranty period, HP will replace software which does not execute its programming instructions due to such defects.

HP does not warrant that the operation of HP products will be uninterrupted or error free. If HP is unable, within a reasonable time, to repair or replace any product to a condition as warranted, you will be entitled to a refund of the purchase price upon prompt return of the product.

HP products may contain remanufactured parts equivalent to new in performance or may have been subject to incidental use.

Warranty does not apply to defects resulting from (a) improper or inadequate maintenance or calibration, (b) software, interfacing, parts, or supplies not supplied by HP, (c) unauthorized modification or misuse, (d) operation outside of the published environmental specifications for the product, or (e) improper site preparation or maintenance. TO THE EXTENT ALLOWED BY LOCAL LAW, THE ABOVE WARRANTIES ARE EXCLUSIVE AND NO OTHER WARRANTY OR CONDITION, WHETHER WRITTEN OR ORAL, IS EXPRESSED OR IMPLIED AND HP SPECIFICALLY DISCLAIMS ANY IMPLIED WARRANTIES OR CONDITIONS OF MERCHANTABILITY, SATISFACTORY QUALITY, AND FITNESS FOR A PARTICULAR PURPOSE. Some countries/regions, states, or provinces do not allow limitations on the duration of an implied warranty, so the above limitation or exclusion might not apply to you. This warranty gives you specific legal rights and you might also have other rights that vary from country/region to country/region, state to state, or province to province.

HP's limited warranty is valid in any country/region or locality where HP has a support presence for this product and where HP has marketed this product. The level of warranty service you receive may vary according to local standards. HP will not alter form, fit, or function of the product to make it operate in a country/region for which it was never intended to function for legal or regulatory reasons. TO THE EXTENT ALLOWED BY LOCAL LAW, THE REMEDIES IN THIS WARRANTY STATEMENT ARE YOUR SOLE AND EXCLUSIVE REMEDIES. EXCEPT AS INDICATED ABOVE, IN NO EVENT WILL HP OR ITS SUPPLIERS BE LIABLE FOR LOSS OF DATA OR FOR DIRECT, SPECIAL, INCIDENTAL, CONSEQUENTIAL (INCLUDING LOST PROFIT OR DATA), OR OTHER DAMAGE, WHETHER BASED IN CONTRACT, TORT, OR OTHERWISE. Some countries/regions, states, or provinces do not allow the exclusion or limitation of incidental or consequential damages, so the above limitation or exclusion may not apply to you. THE WARRANTY TERMS CONTAINED IN THIS STATEMENT, EXCEPT TO THE EXTENT LAWFULLY PERMITTED, DO NOT EXCLUDE, RESTRICT, OR MODIFY AND ARE IN ADDITION TO THE MANDATORY STATUTORY RIGHTS APPLICABLE TO THE SALE OF THIS PRODUCT TO YOU.

## HP's Premium Protection print-cartridge warranty

### Limited Warranty Statement

This HP Print Cartridge is warranted to be free from defects in materials and workmanship.

This warranty does not apply to print cartridges that (a) have been refilled, refurbished, remanufactured or tampered with in any way, (b) experience problems resulting from misuse, improper storage, or operation outside of the published environmental specifications for the printer product or (c) exhibit wear from ordinary use.

To obtain warranty service, please return the product to place of purchase (with a written description of the problem and print samples) or contact HP customer support. At HP's option, HP will either replace products that prove to be defective or refund your purchase price.

TO THE EXTENT ALLOWED BY LOCAL LAW, THE ABOVE WARRANT IS EXCLUSIVE AND NO OTHER WARRANTY OR CONDITION, WHETHER WRITTEN OR ORAL, IS EXPRESSED OR IMPLIED AND HP SPECIFICALLY DISCLAIMS ANY IMPLIED WARRANTIES OR CONDITIONS OF MERCHANTABILITY, SATISFACTORY QUALITY, AND FITNESS FOR A PARTICULAR PURPOSE.

TO THE EXTENT ALLOWED BY LOCAL LAW, IN NO EVENT WILL HP OR ITS SUPPLIERS BE LIABLE FOR DIRECT, SPECIAL, INCIDENTAL, CONSEQUENTIAL (INCLUDING LOST PROFIT OR DATA), OR OTHER DAMAGE, WHETHER BASED IN CONTRACT, TORT, OR OTHERWISE.

THE WARRANTY TERMS CONTAINED IN THIS STATEMENT, EXCEPT TO THE EXTENT LAWFULLY PERMITTED, DO NOT EXCLUDE, RESTRICT OR MODIFY AND ARE IN ADDITION TO THE MANDATORY STATUTORY RIGHTS APPLICABLE TO THE SALE OF THIS PRODUCT TO YOU.

## Extended warranty

In most countries/regions, HP Care Pack provides additional coverage, beyond standard warranty, for the HP device and for all HP-supplied internal components. This hardware maintenance can uplift the standard warranty, for example, from next-day to same-day service, and/or extend it up to 5 years. HP Care Pack can also provide Express Exchange or onsite service. For more information, see the support flyer that came with your device for the appropriate phone numbers and information.

## Print-cartridge information

The print cartridge is designed to simplify replacement of the major consumable parts. The print cartridge contains the printing mechanism and a supply of toner.

At 5-percent page coverage, a standard print cartridge will print approximately 2,000 pages. As the percentage of toner coverage on the page increases, the number of pages that can be printed from a standard print cartridge decreases. These estimates are only approximate; usage conditions and print patterns can cause results to vary.

### Refilled print cartridges

While Hewlett-Packard does not prohibit the use of refilled print cartridges during the warranty period or while the product is under a maintenance contract, it is not recommended for the following reasons:

- Repairs resulting from the use of refilled cartridges are not covered under Hewlett-Packard warranty or maintenance contracts.
- Hewlett-Packard has no control or process to ensure that a refilled cartridge functions at the high level of reliability of a new HP LaserJet toner cartridge. Hewlett-Packard also cannot predict the long-term reliability effect on the product from using different toner formulations found in refilled cartridges.
- The print quality of HP LaserJet print cartridges influences customer perception of the product. Hewlett-Packard has no control over the actual print quality of a refilled cartridge.
- Parts that are critical to print quality might not be replaced when the cartridge is refilled with toner.

### HP LaserJet printing supplies

In many countries/regions, this product's printing supplies (for example the print cartridge) can be returned to HP through the HP Printing Supplies Returns and Recycling Program. An easy-to-use and free take-back program is available in more than 30 countries/regions. Multilingual program information and instructions are included in every new HP LaserJet print cartridge and supplies package.

### HP Printing Supplies Returns and Recycling Program information

Since 1990, the HP Printing Supplies Returns and Recycling Program has collected millions of used LaserJet print cartridges that otherwise might have been discarded in the world's landfills. The HP LaserJet print cartridges and supplies are collected and bulk shipped to our resource and recovery partners, who disassemble the cartridges. Remaining materials are separated and converted into raw materials for use by other industries to make a variety of useful products.

#### U.S. returns

For a more environmentally responsible return of used cartridges and supplies, HP encourages the use of bulk returns. Simply bundle two or more cartridges together and use the single, pre-paid, pre-addressed UPS label that is supplied in the package that the new cartridge comes in. For more information in the U.S., call (1) (800) 340-2445 or visit the HP LaserJet Supplies website at <http://www.hp.com/recycle>.



**Non-U.S. returns**

Non-U.S. customers should call the local HP Sales and Service office or visit the <http://www.hp.com/recycle> website for further information regarding availability of the HP Supplies Returns and Recycling program.

## FCC regulations

This equipment has been tested and found to comply with the limits for a Class B digital device, pursuant to Part 15 of the FCC rules. These limits are designed to provide reasonable protection against harmful interference in a residential installation. This equipment generates, uses, and can radiate radio frequency energy. If not installed and used in accordance with the instructions, it may cause harmful interference to radio communications. However, there is no guarantee that interference will not occur in a particular installation. If this equipment does cause harmful interference to radio or television reception, which can be determined by turning the equipment off and on, the user is encouraged to try to correct the interference by one or more of the following measures:

- Reorient or relocate the receiving antenna.
- Increase separation between equipment and receiver.
- Connect equipment to an outlet on a circuit different from that to which the receiver is located.
- Consult your dealer or an experienced radio/TV technician.

---

**Note**

Any changes or modifications to the product that are not expressly approved by HP could void the user's authority to operate this equipment.

---

**Note**

Use of a shielded interface cable is required to comply with the Class B limits of Part 15 of FCC rules.

---

### FCC Part 68 Requirements (United States)

This equipment complies with FCC rules, Part 68. On the back of this equipment is a label that contains, among other information, the FCC registration number and ringer equivalence number (REN) for this equipment. If requested, this information must be provided to the telephone company. The REN is used to determine the quantity of devices which may be connected to the telephone line. Excessive RENs on the telephone line may result in the devices not ringing in response to an incoming call. In most, but not all, areas, the sum of the RENs should not exceed five (5.0). To be certain of the number of devices that may be connected to the line, as determined by the total RENs, contact the telephone company to determine the maximum REN for the calling area.

This equipment uses the following USOC jack: RJ11C.

An FCC-compliant telephone cord and modular plug is provided with this equipment. This equipment is designed to be connected to the telephone network or premises wiring using a compatible modular jack which is Part 68 compliant. This equipment cannot be used on telephone company-provided coin service. Connection to Party Line Service is subject to state tariffs. If this equipment causes harm to the telephone network, the telephone company will notify you in advance that temporary discontinuance of service may be required. If advance notice is not practical, the telephone company will notify the customer as soon as possible. Also, you will be advised of your right to file a complaint with the FCC if you believe it is necessary. The telephone company may make changes in its facilities, equipment, operations, or procedures that could affect the operation of the equipment. If this happens, the telephone company will provide advance notice in order for you to make the necessary modifications in order to maintain uninterrupted service. If trouble is experienced with this equipment, please see the numbers in the front of this manual for repair and (or) warranty information. If the trouble is causing harm to the telephone network, the telephone company may request you remove the equipment from the network until the problem is resolved. The following repairs can be done by the customer: Replace any original equipment that came with the product. This includes the print cartridge, the supports for trays and bins, the power cord, and the telephone cord. It is recommended that the customer install an ac surge arrester in the ac outlet to which this device is connected. This is to avoid damage to the equipment caused by local lightning strikes and other electrical surges.

## Telephone Consumer Protection Act (United States)

The Telephone Consumer Protection Act of 1991 makes it unlawful for any person to use a computer or other electronic device, including fax machines, to send any message unless such message clearly contains, in a margin at the top or bottom of each transmitted page or on the first page of the transmission, the date and time it is sent and an identification of the business, other entity, or individual sending the message and the telephone number of the sending machine or such business, other entity, or individual. (The telephone number provided cannot be a 900 number or any other number for which charges exceed local or long-distance transmission charges.) In order to program this information into your facsimile, please see the fax guide.

## IC CS-03 requirements

NOTICE: The Industry Canada label identifies certified equipment. This certification means the equipment meets certain telecommunications network protective, operational, and safety requirements as prescribed in the appropriate Terminal Equipment Technical Requirement document(s). The Department does not guarantee the equipment will operate to the user's satisfaction. Before installing this equipment, users should ensure that it is permissible for the equipment to be connected to the facilities of the local telecommunications company. The equipment must also be installed using an acceptable method of connection. The customer should be aware that compliance with the above conditions may not prevent degradation of service in some situations. Repairs to certified equipment should be coordinated by a representative designated by the supplier. Any repairs or alterations made by the user to this equipment, or equipment malfunctions, may give the telecommunications company cause to request the user to disconnect the equipment. Users should ensure for their own protection that the electrical ground connections of the power utility, telephone lines, and internal metallic water pipe system, if present, are connected together. This precaution can be particularly important in rural areas.

---

### CAUTION

---

Users should not attempt to make such connections themselves, but should contact the appropriate electric inspection authority, or electrician, as appropriate. The Ringer Equivalence Number (REN) of this device is 0.7.

**Notice:** The Ringer Equivalence Number (REN) assigned to each terminal device provides an indication of the maximum number of terminals allowed to be connected to a telephone interface. The termination on an interface may consist of any combination of devices subject only to the requirement that the sum of the Ringer Equivalence Number of all the devices does not exceed five (5.0). The standard connecting arrangement code (telephone jack type) for equipment with direct connections to the telephone network is CA11A.

# Declaration of Conformity

## Declaration of Conformity

according to ISO/IEC Guide 22 and EN 45014

**Manufacturer's Name:** Hewlett-Packard Company  
**Manufacturer's Address:** 11311 Chinden Boulevard  
Boise, Idaho 83714-1021, USA

### declares that the product

**Product Name:** LaserJet 3015/3020/3030 products  
**Regulatory Model Number:** LJ 3015<sup>3</sup>: BOISB-707-00  
LJ 3020<sup>3</sup>: BOISB-0306-00  
LJ 3030<sup>3</sup>: BOISB-0306-01  
**Product Options:** All

### conforms to the following Product Specifications:

**Safety:** IEC 60950:1999 / EN 60950:2000  
IEC 60825-1:1993 + A1:1996 + A2:2001 / EN 60825-1:1994 + A11:1996 + A2:2001 (Class 1 Laser/LED Product)  
GB4943-1995

**EMC:** CISPR 22:1998 / EN 55022:1998 - Class B<sup>1</sup>  
EN 61000-3-2:1995 / A14:2000  
EN 61000-3-3:1995  
EN 55024:1998  
FCC Title 47 CFR, Part 15 Class B<sup>2</sup> / ICES-003, Issue 3  
GB9254-1998  
**Telecom:** TBR-21:1998; EG 201 121:1998

### Supplementary Information:

The product herewith complies with the requirements of the EMC Directive 89/336/EEC, the Low Voltage Directive 73/23/EEC, the R&TTE Directive 1995/5/EC (Annex II), and carries the CE-Marking accordingly:

<sup>1</sup> The product was tested in a typical configuration with Hewlett-Packard Personal Computer Systems.

<sup>2</sup> This Device complies with Part 15 of the FCC Rules. Operation is subject to the following two Conditions: (1) this device may not cause harmful interference, and (2) this device must accept any interference received, including interference that may cause undesired operation.

<sup>3</sup> For regulatory purposes, this product is assigned a Regulatory model number. This number should not be confused with the marketing name (HP LaserJet 3015/3020/3030) or the product number (Q2669A for the HP LaserJet 3015 and Q2665A for the HP LaserJet 3020 and Q2666A for the HP LaserJet 3030).

Boise, Idaho 83714-1021, U.S.A.

**November 1, 2003**

### For regulatory topics only:

**Australia Contact** Product Regulations Manager, Hewlett-Packard Australia, Ltd. 31-41 Joseph Street Blackburn, Victoria 3130, Australia

**European Contact** Your Local Hewlett-Packard Sales and Service Office or Hewlett-Packard GmbH, Department HQ-TRE / Standards Europe Herrenberger Strasse 140 Böblingen, D-71034, (+49-7031-14-3143)

**USA Contact** Product Relations Manager, Hewlett-Packard Company PO Box 15, Mail Stop 160 Boise, ID 83707-0015, USA (208-396-6000)

# Safety statements

## Laser safety statement

The Center for Devices and Radiological Health (CDRH) of the U.S. Food and Drug Administration has implemented regulations for laser products manufactured since August 1, 1976. Compliance is mandatory for products marketed in the United States. This printer is certified as a "Class 1" laser product under the U.S. Department of Health and Human Services (DHHS) Radiation Performance Standard according to the Radiation Control for Health and Safety Act of 1968. Since radiation emitted inside this printer is completely confined within protective housings and external covers, the laser beam cannot escape during any phase of normal user operation.

---

### WARNING!

---

Using controls, making adjustments, or performing procedures other than those specified in this manual can result in exposure to hazardous radiation.

## Canada DOC regulations

This equipment complies with Canadian EMC Class B requirements.

Conforme à la classe B des normes canadiennes de compatibilité électromagnétiques. << CEM>>.

## Laser statement for Finland

### LASERTURVALLISUUS LUOKAN 1 LASERLAITE KLASS 1 LASER APPARAT

HP LaserJet 3315/3020/3030 all-in-one-laserkirjoitin on käyttäjän kannalta turvallinen luokan 1 laserlaite. Normaalisissa käytössä kirjoittimen suojakotelointi estää lasersäteiden pääsyn laitteen ulkopuolelle.

Laitteen turvallisuusluokka on määritetty standardin EN 60825-1:1994 + A11:1996 + A2:2001 mukaisesti.

#### **VAROITUS!**

Laitteen käyttäminen muulla kuin käyttöohjeessa mainitulla tavalla saattaa altistaa käyttäjän turvallisuusluokan 1 ylittävälle näkymättömälle lasersäteilylle.

#### **WARNING!**

Om apparaten används på annat sätt än i bruksanvisning specificerats, kan användaren utsättas för osynlig laserstrålning, som överskrider gränsen för laserklass 1.

#### **HUOLTO**

HP LaserJet 3015/3020/3030 all-in-one-kirjoittimen sisällä ei ole käyttäjän huollettavissa olevia kohteita. Laitteen saa avata ja huoltaa ainoastaan sen huoltamiseen koulutettu henkilö. Tällaiseksi huoltotoimenpiteeksi ei katsota väriainekasetin vaihtamista, paperiradan puhdistusta tai muita käyttäjän käsikirjassa lueteltuja, käyttäjän tehtäväksi tarkoitettuja ylläpitotoimia, jotka voidaan suorittaa ilman erikoistyökaluja.

#### **VARO!**

Mikäli kirjoittimen suojakotelo avataan, olet alttiina näkymättömälle lasersäteilylle laitteen ollessa toiminnassa. Älä katso säteeseen.

#### **WARNING!**

Om laserprinterns skyddshölje öppnas då apparaten är i funktion, utsättas användaren för osynlig laserstrålning. Betrakta ej strålen.

Tiedot laitteessa käytettävän laserdiodin säteilyominaisuuksista:

Aallonpituus 770-795 nm

Teho 5 mW

Luokan 3B laser

## Korean EMI statement

사용시 안내문 (A급 기기)

이 기기는 업무용으로 전자파장애감정을 받은 기기이오니, 만약 잘못 구입하셨을 때에는 구입한 곳에서 비입무용으로 교환하시기 바랍니다.

## Australian EMC requirements

This equipment complies with Australian EMC requirements.



## Regulatory information for the European Union countries/regions

This equipment has been designed to work in all of the countries/regions of the European Economic Area (Public Switched Telephone Networks) only. Network compatibility is dependent on internal software settings. Contact your equipment supplier if it is necessary to use the equipment on a different telephone network. For further product support, contact Hewlett-Packard at the phone numbers provided in the support flyer that came with the product.



# 2

## Operation

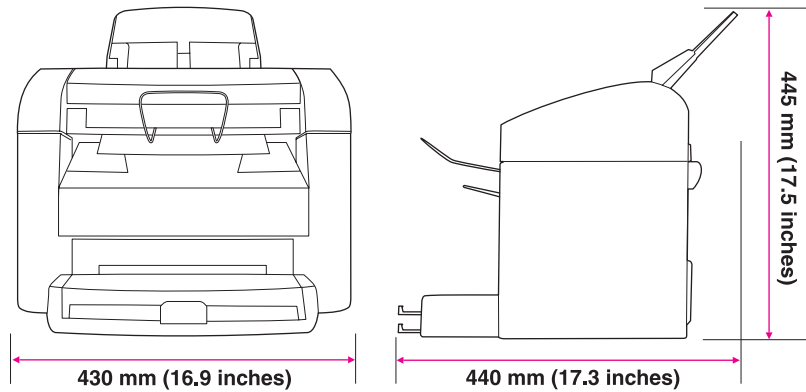
This chapter provides information about the following topics.

Operating environment.....	30
Identifying the control-panel components.....	31
Control-panel menu structure.....	33
To use the control-panel buttons.....	33
To print the control-panel menu structure.....	33
Product media specifications .....	37
Main input tray (all models) .....	37
Automatic document feeder (ADF) specifications.....	38
To gain access to the optimizing feature.....	38
Guidelines for using media.....	39
Paper and transparencies .....	39
Common media problems table.....	39
Labels.....	40
Envelopes.....	40
Card stock and heavy media .....	41
Loading media .....	43
Media input tray .....	43
Priority input tray .....	43
Specific types of media .....	43
Media information for ADF originals .....	43
Media information for the flatbed (HP LaserJet 3020 and 3030) .....	44
Loading originals to copy or scan.....	44
Loading originals into the LJ 3020 and 3030 ADF input tray.....	45
Loading originals onto the LJ 3020 and 3030 flatbed scanner.....	46

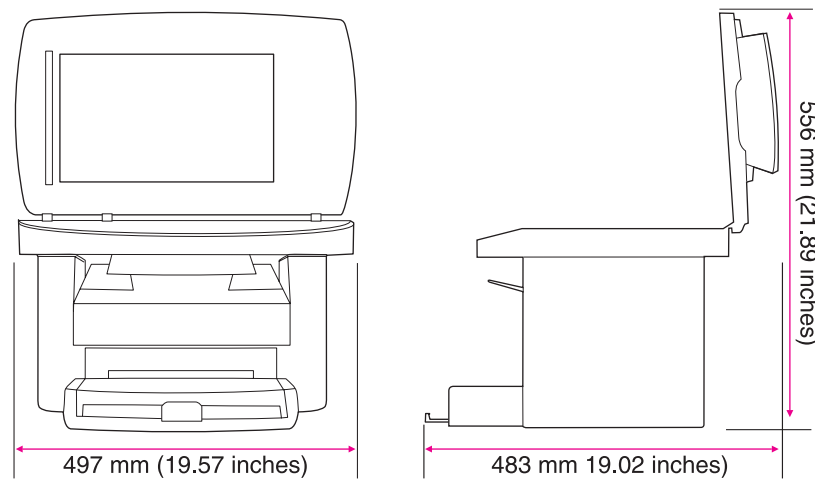
## Operating environment

Place the product on a sturdy, level surface in a well-ventilated area that meets the following environmental requirements:

- temperature (operating): 15° to 32.5° C (59° to 90.5° F)  
temperature (storage): -20° to 40° C (-4° to 104° F)
- humidity (operating): 10 to 80 percent relative humidity (no condensation)  
humidity (storage): less than 95 percent relative humidity (no condensation)
- away from direct sunlight, open flames, and ammonia fumes
- sufficient space around the product to allow for access and ventilation



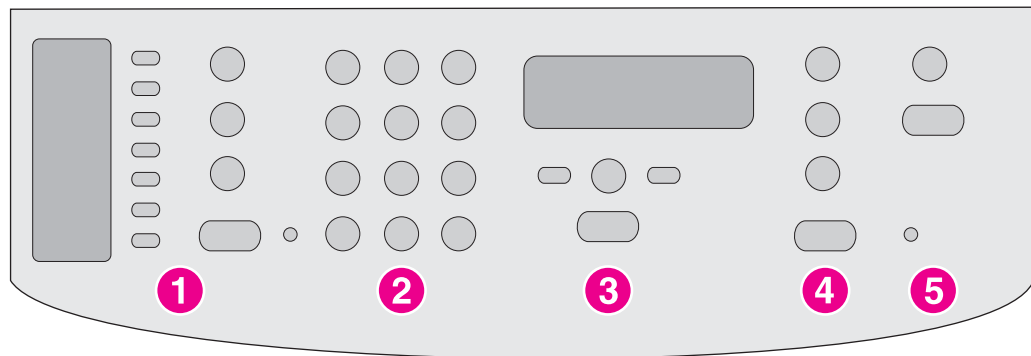
**Figure 2-1. HP LaserJet 3015 dimensions**



**Figure 2-2. HP LaserJet 3020/3030 dimensions**

## Identifying the control-panel components

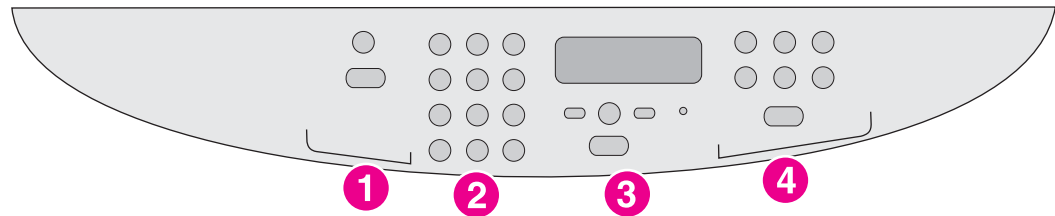
This section provides details about the control-panel components.



**Figure 2-3.**

### HP LaserJet 3015 all-in-one control panel

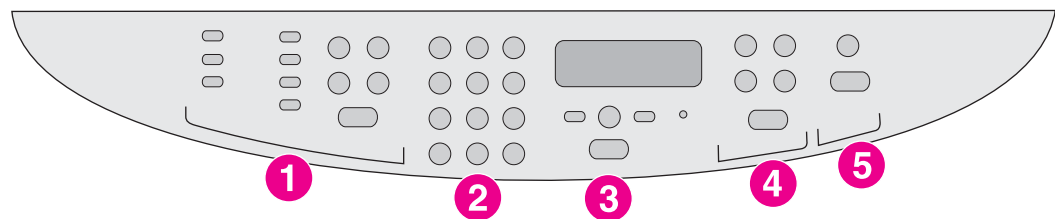
- 1 **Fax controls.** Use the fax controls to send and receive faxes and to change commonly used fax settings. See the fax guide for information about using the fax controls.
- 2 **Alphanumeric buttons.** Use the alphanumeric buttons to type data into the product control-panel display and to dial phone numbers for faxing. For information about using alphanumeric buttons, see the fax guide.
- 3 **Menu and cancel controls.** Use these controls to select menu options, determine the product status, and cancel the current job.
- 4 **Copy controls.** Use these controls to change commonly used default settings and to start copying.
- 5 **Scan controls.** Use these controls to scan to e-mail or to a folder.



**Figure 2-4.**

**HP LaserJet 3020 all-in-one control panel**

- 1 **Scan controls.** Use these controls to scan to e-mail or to a folder.
- 2 **Alphanumeric buttons.** Use the alphanumeric buttons to type data into the product control panel display.
- 3 **Menu and cancel controls.** Use these controls to select menu options, determine the product status, and cancel the current job.
- 4 **Copy controls.** Use these controls to change commonly used default settings and to start copying.



**Figure 2-5.**

**HP LaserJet 3030 all-in-one control panel**

- 1 **Fax controls.** Use the fax controls to change commonly used fax settings. For information about using the fax controls, see the fax guide.
- 2 **Alphanumeric buttons.** Use the alphanumeric buttons to type data into the product control-panel display and to dial phone numbers for faxing. For information about using alphanumeric buttons, see the fax guide.
- 3 **Menu and cancel controls.** Use these controls to select menu options, determine the product status, and cancel the current job.
- 4 **Copy controls.** Use these controls to change commonly used default settings and to start copying.
- 5 **Scan controls.** Use these controls to scan to e-mail or to a folder.

## Control-panel menu structure

Use the following hierarchical diagram of the control-panel menu structure to make changes to settings and features.

### To use the control-panel buttons

1. Press **MENU/ENTER** to begin.
2. Use the **<** or **>** button to scroll to select one of the options from the main menu, and then press **MENU/ENTER**.
3. Use the **<** or **>** button to scroll to select one of the options from the submenu, and then press **MENU/ENTER**.
4. If applicable, use the **<** or **>** button to select one of the options from the second submenu, and then press **MENU/ENTER**.

### To print the control-panel menu structure

1. Press **MENU/ENTER**.
2. Use the **<** or **>** button to select **Reports**, and then press **MENU/ENTER**.
3. Use the **<** or **>** button to select **Menu structure**, and then press **MENU/ENTER**. The product exits the menu settings and prints the report.

To see which settings are currently selected, print a configuration report. See [Troubleshooting tools](#) for instructions.

---

#### Note

Some menu items might not be available depending on the product model. For example, the **Fax Job Status** menu item does not apply to the HP LaserJet 3020 because that product does not have fax capabilities.

**Table 2-1. Control-panel menu structure**

Main Menu	Submenu	Submenu	Submenu
<b>Fax Job status</b>			
<b>Fax Functions</b>	<b>Send fax later</b> <b>Stop Recv to PC</b> <b>Reprint last</b> <b>Polling receive</b> <b>Clear saved faxes</b>		
<b>Time/Date, Header</b>	<b>Time/Date</b> <b>Fax Header</b>		

**Table 2-1. Control-panel menu structure (continued)**

<b>Main Menu</b>	<b>Submenu</b>	<b>Submenu</b>	<b>Submenu</b>
<b>Copy setup</b>	<b>Default Quality</b> <b>Def. Light/Dark</b> <b>Def. Collation</b> <b>Def. # of copies</b> <b>Def. Redu/Enlrg</b>		
<b>Reports</b>	<b>Demo Page</b>		
	<b>Fax Activity log</b>	<b>Print log now</b> <b>Auto Log Print</b>	
	<b>Fax Call report</b>	<b>Print report now</b> <b>Print report</b> <b>Include 1st page</b>	
	<b>PhoneBook report</b> <b>Menu structure</b> <b>Config report</b> <b>Block Fax list</b> <b>Billing report</b> <b>Usage page</b> <b>PCL Font list</b> <b>PS Font list</b> <b>All fax reports</b>		



**Table 2-1. Control-panel menu structure (continued)**

Main Menu	Submenu	Submenu	Submenu
Fax setup	Phone Book	Individual setup	Add Delete
		Group setup	Add/Edit group Delete group Del. # In group
		Delete all	
	Fax Send setup	Def. Resolution Def. Light/Dark Def. Glass Size Dialing Mode Redial if busy Redial-no answer Redial Comm Err. Dial Prefix Detect dial tone Billing codes	
	Fax Recv. setup	Answer mode Rings To answer Answer Ring Type Extension Phone Silence Detect Fit to page Stamp faxes Forward fax	
		Block faxes	Add entry Delete entry Clear all
	All faxes	Error correction V.34	
Common settings	Language Def. Paper Size Print Density		
	Volume settings	Alarm volume Ring volume Key Press volume PhoneLine Volume	

**Table 2-1. Control-panel menu structure (continued)**

Main Menu	Submenu	Submenu	Submenu
<b>Service</b>	<b>Print T.30 trace</b> <b>Restore defaults</b> <b>Cleaning Mode</b> <b>Power Save time</b> <b>(HP LaserJet 3020</b> <b>and 3030 only)</b> <b>Less paper curl</b>		

## Product media specifications

The product accepts a variety of media. Properties such as weight, grain, and moisture content are important factors that affect printer performance and output quality. Media should conform to the guidelines in the user guide on the product CD. Media that does not meet HP guidelines might cause poor print quality, increased jams, or premature wear on the product.

### CAUTION

Damage caused by media that does not meet HP's specifications is not covered by the HP warranty or service agreements.

### Main input tray (all models)

The printer supports media within this size range:

- **Minimum:** 76 by 127 mm (3 by 5 inches)
- **Maximum:** 216 by 356 mm (8.5 by 14 inches)

Media-type settings control the temperature of the fuser. To optimize the print quality, change the settings to match the media that you are using. The following are the media types that the product supports and the associated fuser mode.

**Table 2-2. Supported media types**

Media type	Fuser mode
Plain	Light
Preprinted	Normal
Letterhead	Normal
Transparency	Light
Prepunched	Normal
Labels	Thick
Bond	Thick
Recycled	Normal
Color	Normal
Light <75 g/m <sup>2</sup>	Light
Heavy (90 to 105 g/m <sup>2</sup> )	Thick
Cardstock (105 to 176 g/m <sup>2</sup> )	Thick 2
Envelope	Envelope
Rough	Thick
Unspecified	Uses default setting

### Note

Narrow and heavy media can cause the printer to print more slowly.

## Automatic document feeder (ADF) specifications

### HP LaserJet 3015 product

- **Input capacity:** The ADF holds up to 30 sheets of flat 16 lb copier-grade paper.
- **Media weight:** See [HP LaserJet 3015 performance specifications](#).
- **Media size:** Use copier-grade paper that is within the following size ranges only:
  - **Minimum:** 74 by 105 mm (2.9 by 4.1 inches)
  - **Maximum:** 215.9 by 356 mm (8.5 by 14 inches)

### HP LaserJet 3020 and 3030

- **Input capacity:** The ADF holds up to 50 sheets of flat 16 lb copier-grade paper.
- **Media weight:** See [HP LaserJet 3020/3030 performance specifications](#).
- **Media size:** Use copier-grade paper that is within the following size ranges only:
  - **Minimum:** 127 by 127 mm (5 by 5 inches)
  - **Maximum:** 215.9 by 381 mm (8.5 by 15 inches)

## To gain access to the optimizing feature

You can gain access to the optimizing feature on the **Paper** tab or the **Paper/Quality** tab in the device properties (printer driver).

---

### Note

Printing speeds might vary depending on the type and size of media used.

You might need to change the setting again to optimize for the type of media on which you normally print.

---

## Guidelines for using media

Use the information in this section to choose the proper print media.

### Paper and transparencies

Paper must be of good quality and free of cuts, nicks, tears, spots, loose particles, dust, wrinkles, holes, and curled or bent edges. Check the label on the paper package for details about the type of paper (such as bond or recycled).

Some paper causes print-quality problems, jamming, or damage to the printer.

#### Note

Do not use letterhead that is printed with low-temperature inks, such as those used in some types of thermography; raised letterhead; or colored paper or preprinted forms that use inks incompatible with the printer temperature (200° C, or 392° F, for 0.1 second).

Transparencies must be able to withstand 200° C (392° F), the printer's maximum temperature.

### Common media problems table

Symptom	Problem with media	Solution
Poor print quality or toner adhesion, or problems with feeding.	Too moist, too rough, too smooth, or embossed. Faulty lot.	Try another kind of media between 100 and 250 Sheffield. Use a fresh media.
Poor toner adhesion.	Fuser temperature is too low. Too smooth.	Try a higher fuser temperature setting. Try another kind of media between 100 and 250 Sheffield.
Dropouts, jamming, or curl.	Stored improperly.	Store paper flat in its moisture-proof wrapping.
Increased gray background shading over the entire page.	Media is not white enough or the contrast setting is set too high.	Use whiter paper. Lower the contrast setting,
Increased gray background shading along the edges or bottom of the page.	The media weight is too heavy. The contrast setting is set too high.	Use lighter weight paper. Lower the contrast setting,
Excessive curl, or problems with feeding.	Too moist, wrong grain direction, or short-grain construction.	Use long-grain paper. For copy or fax jobs, select <b>less paper curl</b> in the service menu. For print jobs, select a lighter-weight media type from the printer driver or the HP Toolbox.
Jamming, or damage to device.	Cutouts or perforations.	Do not use media with cutouts or perforations.
Problems with feeding.	Ragged edges.	Use good-quality media.

## Labels

---

**Note**

For best results, use only HP-brand labels. To order HP supplies, visit <http://www.hp.com>.

When selecting labels, consider the quality of the following factors:

- **Adhesives:** The adhesive material should be stable at 200° C (392° F), the products maximum temperature.
- **Arrangement:** Use only labels that have no exposed backing between them. Labels can peel off sheets that have spaces between the labels, causing serious jams.
- **Curl:** Before printing, labels must lie flat with no more than 13 mm (0.5 inch) of curl in any direction.
- **Condition:** Do not use labels that have wrinkles, bubbles, or other indications of separation. Never use a sheet of labels that has already been run through the device.

## Envelopes

When selecting envelopes, consider the quality of the following factors.

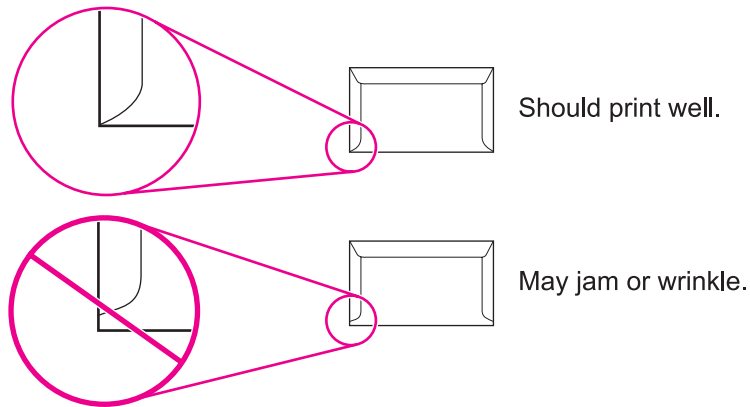
### Envelope construction

Envelope construction is critical. Envelope fold lines can vary considerably, not only between manufacturers, but also within a box from the same manufacturer. Successful printing on envelopes depends on the quality of the envelopes, which includes the following factors:

- **Weight:** The weight of the envelope paper should not exceed 105 g/m<sup>2</sup> (28 lb), or jamming might result.
- **Construction:** Before printing, envelopes should lie flat with less than 6 mm (0.25 inch) curl and should not contain air. Envelopes that trap air might cause problems.
- **Condition:** Make sure that the envelopes are not wrinkled, nicked, or otherwise damaged.
- **Sizes:** Supported envelope sizes range from 90 by 160 mm (3.5 by 6.3 inches) to 178 by 254 mm (7 by 10 inches).

## Envelopes with double-side seams

An envelope with double-side-seam construction has vertical seams at both ends of the envelope rather than diagonal seams. This style is more likely to wrinkle during printing. Make sure that the seam extends all the way to the corner of the envelope as shown in the following illustration:



**Figure 2-6.** Envelope construction

## Envelopes with adhesive strips or flaps

Envelopes with a peel-off adhesive strip or with more than one flap that folds over to seal must use adhesives that are compatible with the heat and pressure in the device (200° C or 392° F). The extra flaps and strips might cause wrinkling, creasing, or jams.

## Envelope storage

Proper storage of envelopes contributes to good print quality. Store envelopes flat to ensure good print quality. If air is trapped in an envelope, creating an air bubble, the envelope might wrinkle during printing.

## Card stock and heavy media

Some card stock performs better than others because the construction is better suited for feeding through a laser device. For optimum device performance, do not use media heavier than 157 g/m<sup>2</sup> (42 lb). Media that is too heavy might cause misfeeds, stacking problems, media jams, poor toner fusing, poor print quality, or excessive mechanical wear.

---

### Note

---

You might be able to print on heavier media if you do not fill the input trays to capacity and if you use media with a smoothness rating of 100 to 180 Sheffield.

## Card stock construction

- **Smoothness:** 135 to 157 g/m<sup>2</sup> (36 to 42 lb) card stock should have a smoothness rating of 100 to 180 Sheffield. 60 to 135 g/m<sup>2</sup> (16 to 36 lb) card stock should have a smoothness rating of 100 to 250 Sheffield.
- **Construction:** Card stock should lie flat with less than 5 mm (0.2 inch) of curl.

- **Condition:** Make sure that the card stock is not wrinkled, nicked, or otherwise damaged.
- **Sizes:** Use card stock that is within the following size ranges only:
  - **Minimum:** 76 by 127 mm ( 3 by 5 inches))
  - **Maximum:** 216 by 356 mm ( 8.5 by 14 inches))

---

**Note**

---

The HP LaserJet 3015 ADF output bin holds one sheet of legal-size media (215 by 356 mm [8.5 by 14 inches]). Subsequent sheets of legal-size media slide off of the ADF output bin.

### **Card stock guidelines**

Set margins at least 2 mm ( 0.08 inch) away from the edges.



## Loading media

This section provides information about loading media in the input trays.

### Media input tray

The media input tray holds up to 150 sheets of 60-g/m<sup>2</sup> (16-lb) paper or a 25-mm (0.98-inch) stack of heavier media. Load media with the top forward and the side to be printed on facing up. To prevent jams and skew, always adjust the side media guides.

### Priority input tray

The priority input tray holds up to 10 pages of 75-g/m<sup>2</sup> (20-lb) paper or one envelope, transparency, or card. Load media with the top forward and the side to be printed on facing up. To prevent jams and skew, always adjust the side media guides.

If you try to print on media that is wrinkled, folded, or damaged in any way, a jam might occur. See the user guide on the product CD for more information.

---

#### Note

---

When you add new media, make sure that you remove all of the media from the input tray and straighten the stack of new media. This helps prevent multiple sheets of media from feeding through the printer at one time, reducing jams.

### Specific types of media

- **Transparencies and labels:** Load transparencies and labels with the top forward and the side to be printed on facing up. See the user guide on the product CD for more information.
- **Envelopes:** Load envelopes with the narrow, stamp side forward and the side to be printed on facing up. See the user guide on the product CD for more information.
- **Letterhead and preprinted forms:** Load with the top forward and the side to be printed on facing up. See the user guide for more information.
- **Cards and custom-sized media:** Load with the narrow side forward and the side to be printed on facing up. See the user guide on the product CD for more information.

### Media information for ADF originals

---

#### Note

---

**HP LaserJet 3015:** you must use a carrier sheet to scan or copy small or delicate originals (such as newsprint, business cards, and photos), or documents that have tears, perforations, or punch holes.

**HP LaserJet 3020 and 3030:** you must use the flatbed to scan or copy small or delicate originals (such as newsprint, business cards, and photos), or documents that have tears, perforations, or punch holes. If you want to fax such items, first make a copy on the flatbed and then fax the copy.

Perform the following actions to minimize the possibility of jams:

- Remove self-stick notes.
- Remove staples and paper clips.
- Straighten any curls, folds, or wrinkles in documents before putting them into the document feeder tray.

- Do not insert any document that contains glue, correction fluid, or wet ink.
- Do not insert gum-backed paper or labels.
- Avoid multiple-copy forms.
- Do not scan originals that are larger or smaller than supported size limitations.

---

**Note**

---

To obtain good results, it is important to use the correct re-entry and color settings for the job. See the user guide on the product CD for more information.

## Media information for the flatbed (HP LaserJet 3020 and 3030)

Use the flatbed scanner for copying, scanning, and faxing if the media is fragile, thin, thick, or damaged (folded, wrinkled), or to produce a high-quality copy or file. The flatbed scanner provides the best copy and scan quality.

The flatbed has no minimum size specification, and accepts a maximum size of letter- (215.9 mm by 279 mm, or 8.5 inches by 11 inches) or A4- (210 mm by 297 mm, or 9.26 inches by 11.69 inches) size media.

---

**Note**

---

To scan a legal-size document using the HP LaserJet 3020 or 3030, use the automatic document feeder.

## Loading originals to copy or scan

Use these instructions to load originals into the product for copying or scanning. See the specific instructions for the model that you are servicing.

---

**Note**

---

Automatic document feeder (ADF) capacity is up to 30 sheets of 75-g/m<sup>2</sup> (20-lb) media (depending on the thickness of the media), or until the ADF input tray is full.

The minimum size for media in the ADF input tray is 74 by 105 mm (2.9 by 4.1 inches). The maximum size for media in the ADF input tray is 215 by 356 mm (8.5 by 14 inches).

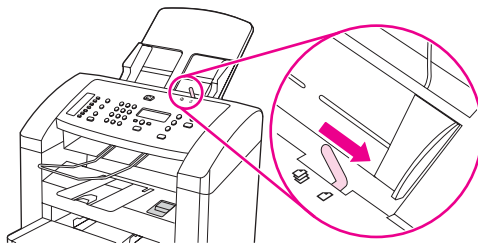
1. Adjust the ADF media lever, if necessary.

---

**Note**

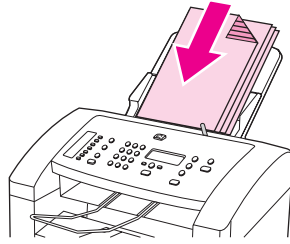
---

Move the ADF media lever to the right (single-sheet setting) if you are printing on a single sheet of thick media.



**Figure 2-7.** Loading the LJ 3015 ADF (1 of 3)

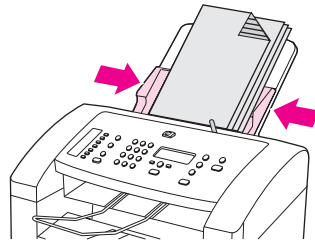
- Put the top end of the original media stack into the ADF input tray, with the media stack face down and the first page to be scanned at the bottom of the stack.



**Figure 2-8.**

#### **Loading the LJ 3015 ADF (2 of 3)**

- Slide the media stack into the ADF until the media does not move any farther. You might have to tap the stack into the ADF.
- Adjust the media guides until they are snug.



**Figure 2-9.**

#### **Loading the LJ 3015 ADF (3 of 3)**

- The document is now ready to be scanned.

---

#### **CAUTION**

To prevent damaging the device, do not use an original that has correction fluid, correction tape, or staples.

If you moved the ADF media lever to the right in step 1, move it back to the left when you have finished printing. Printing on regular media with the ADF media lever moved to the right can cause jams.

---

### **Loading originals into the LJ 3020 and 3030 ADF input tray**

---

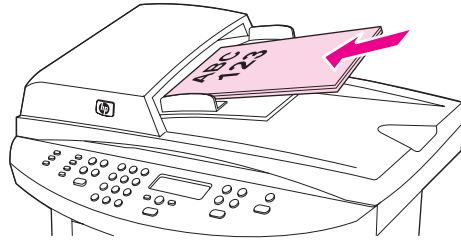
#### **Note**

The ADF capacity is up to 50 sheets of 75-g/m<sup>2</sup> (20-lb) media.

The minimum size for media in the ADF is 127 by 127 mm (5 by 5 inches). For smaller sizes, use the flatbed scanner. The maximum size for media in the ADF is 216 by 381 mm (8.5 by 15 inches).

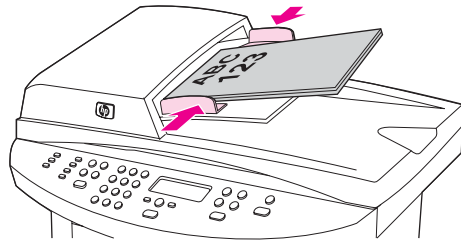
- Make sure that the flatbed scanner contains no media.

2. Close the flatbed scanner cover and put the top end of the stack of originals into the ADF input tray, with the media stack face-up and the first page to be copied on top of the stack.



**Figure 2-10.** Loading the LJ 3020 and 3030 ADF (1 of 2)

3. Slide the stack into the ADF until it does not move any farther.
4. Adjust the media guides until they are snug against the media.



**Figure 2-11.** Loading the LJ 3020 and 3030 ADF (2 of 2)

5. The document is now ready to be copied.

---

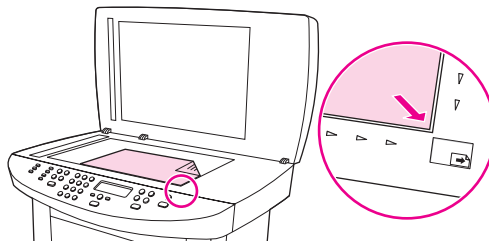
**CAUTION**

---

To prevent damaging the device, do not use an original that contains correction tape, correction fluid, or staples.

## Loading originals onto the LJ 3020 and 3030 flatbed scanner

1. Make sure that the automatic document feeder (ADF) contains no media.
2. Lift the flatbed scanner cover.
3. Place the original document face-down on the flatbed scanner with the top, left corner of the document at the lower-right corner of the glass.
4. Gently close the lid.
5. The document is ready to be copied.



**Figure 2-12.** Loading the LJ 3020 and 3030 flatbed scanner

---

**CAUTION**

---

To prevent damaging the device, do not allow the scanner lid to fall onto the flatbed scanner surface. Always close the scanner lid when the device is not in use.

# 3

## Maintenance

This chapter provides information about the following topics.

Life expectancies of parts that wear .....	48
Scanner calibration .....	49
Cleaning the product .....	50
To clean the print path .....	50
Cleaning the glass.....	50
Cleaning the print-cartridge area.....	54
To cleaning the print-cartridge area (all models).....	54
Cleaning the printer pickup roller (all models).....	55
Cleaning the printer separation pad (all models).....	56
User replaceable parts.....	57
Printer pickup roller (all models).....	57
Printer separation pad (all models).....	59
Printer main input tray (all models).....	60
HP LaserJet 3015 ADF pickup roller .....	61
HP LaserJet 3015 ADF separation pad set.....	62
HP LaserJet 3015 ADF input tray.....	62
HP LaserJet 3015 ADF output bin.....	63
HP LaserJet 3020 and 3030 ADF pickup roller.....	63
HP LaserJet 3020 and 3030 ADF separation pad.....	66
HP LaserJet 3020 and 3030 control-panel bezel.....	66

## Life expectancies of parts that wear

Inspect any parts that wear when servicing the product. Replace them as needed, based on failure or wear, rather than on usage.

The following table lists approximate schedules for replacing consumables.

**Table 3-1. Life expectancies of parts that wear**

Description	Part number	Life (estimated)	Remarks
Print cartridge (user-replaceable) <sup>PC1</sup>	Q2612A	2,000 pages (at 5 percent toner coverage)	When print becomes faint, redistribute toner in the cartridge by gently shaking the cartridge from side to side.
Product base pickup roller	RL1-0266-000CN	50,000 pages	Look for glazing and/or cracks. Can affect print quality and paper movement.
Product base separation pad	RC1-1985-000CN	50,000 pages	Can affect paper movement.
Fuser assembly (100-127 V)	RM1-0862-000CN	50,000 pages	Can affect print quality and paper movement.
Fuser assembly (220-240 V)	RM1-0863-000CN	50,000 pages	Can affect print quality and paper movement.
<b>HP LaserJet 3015</b> ADF separation pad set	RM1-0891-000CN	25,000 pages	Can affect movement of documents to be scanned or copied.
<b>HP LaserJet 3015</b> ADF separation pad assembly	RM1-0890-000CN	25,000 pages	Can affect movement of documents to be scanned or copied.
<b>HP LaserJet 3020/3030</b> ADF separation pad	C7309-60009	50,000 pages	Can affect movement of documents to be scanned or copied.
<b>HP LaserJet 3015</b> ADF pickup roller	RM1-0885-000CN	25,000 pages	Can affect movement of documents to be scanned or copied.
<b>HP LaserJet 3020/3030</b> ADF pickup roller	C709-60109	50,000 pages	Can affect movement of documents to be scanned or copied.

<sup>PC1</sup>The estimated print cartridge life is based on letter- or A4-sized paper with an average of 5-percent toner coverage and a medium density setting. Print cartridge life can be extended further by using draft-mode settings to conserve toner.

## Scanner calibration

The scanner calibrates itself automatically at the start of scan of copy jobs. Normally, you do not need to initiate the calibration, but you can initiate the calibration through the secondary service menu and produce a report that shows the calibration results. See [Secondary service menu](#).

## Cleaning the product

---

### WARNING!

Before you perform these steps, unplug the product to avoid the shock hazard.

To maintain quality, thoroughly clean the product when these conditions exist:

- any time a new print cartridge is installed
- after printing approximately 2,000 pages
- whenever print quality problems appear

Clean the outside of the product by using a water-dampened cloth. Clean the inside by using only a dry, lint-free cloth (such as a lens tissue).

To avoid permanent damage to the print cartridge, do not use ammonia-based or ethyl alcohol-based cleaners on or around the product.

---

### WARNING!

Avoid touching the heating element in the fuser. It might be very hot and can cause burns.

---

### CAUTION

Do not touch the surface of the black-sponge transfer roller. Contaminants on the roller can cause print-quality problems.

## To clean the print path

The product features a special cleaning mode to clean the paper path.

This process requires using a transparency to remove dust and toner from the print paper path. Do not use bond or rough paper.

Make sure that the transparency used in this cleaning process meets the media requirements for the printer.

If transparency film is unavailable, you can use paper. If you must use paper, perform the procedure two or three times to ensure proper cleaning.

## To clean the print path

1. If one is available, load a transparency in the priority input tray.
2. Make sure that the product is in the **Ready** state.
3. Press **MENU/ENTER**, and then use the **<** or **>** button to scroll to **Service** and press **MENU/ENTER**.
4. Use the **<** or **>** button to scroll to **Cleaning Mode** and press **MENU/ENTER**.
5. The transparency feeds through the printer slowly. Discard the transparency.

---

### Note

The **FAX/SEND** (HP LaserJet 3015 and 3030 only) and **CANCEL** lights blink until the cleaning process is complete.

## Cleaning the glass

Use the following procedures to clean the glass on the scanner.

## To clean the exterior (all models)

Use a soft, damp, lint-free cloth to wipe dust, smudges, and stains off the exterior of the device.



## To clean the LJ 3015 glass and white platen

Over time, specks of debris might collect on the scanner glass and white platen, which can affect performance. Use the following procedure to clean the scanner glass and white platen.

1. Use the power switch to turn off the product, and then unplug the power cord from the electrical socket.
2. Tilt the device control panel forward.
3. Clean the glass strip and the white platen with a soft cloth or sponge that has been moistened with nonabrasive glass cleaner.

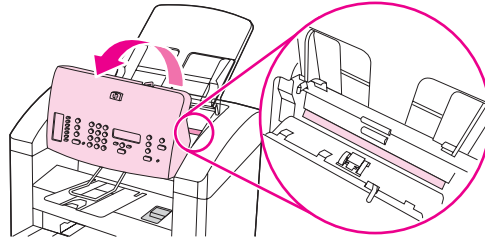


Figure 3-1.

### Cleaning the LJ 3015 glass

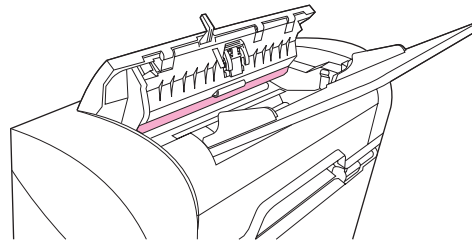


Figure 3-2.

### Cleaning the LJ 3015 white platen

---

#### CAUTION

---

Do not use abrasives, acetone, benzene, ammonia, ethyl alcohol, or carbon tetrachloride on any part of the device; these can damage the device. Do not place liquids directly on the glass or platen. They might seep and damage the device.

4. Dry the glass and platen with a chamois or cellulose sponge to prevent spotting.
5. Plug the product in and use the power switch to turn on the product.

## To clean the LJ 3020 and 3030 glass

Dirty glass, from fingerprints, smudges, hair, and so on, slows down performance and affects the accuracy of special features such as fit-to-page and copy.

---

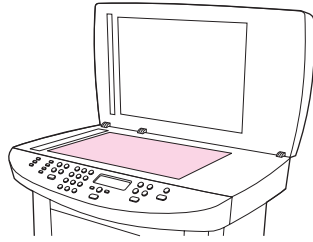
#### Note

---

If streaks or other defects appear only on copies produced using the automatic document feeder (ADF), clean the scanner strip (step 3). It is not necessary to clean the scanner glass.

1. Use the power switch to turn off the device, unplug the power cord from the electrical socket, and then raise the lid.

2. Clean the glass by using a soft cloth or sponge that has been moistened with nonabrasive glass cleaner.



**Figure 3-3.** Cleaning the LJ 3020 and 3030 glass (1 of 2)

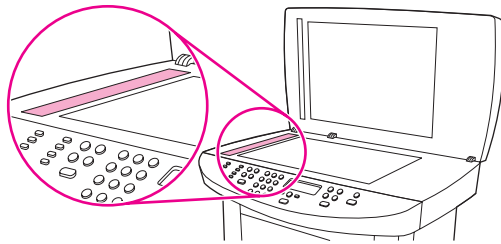
---

**CAUTION**

---

Do not use abrasives, acetone, benzene, ammonia, ethyl alcohol, or carbon tetrachloride on any part of the device; these can damage the device. Do not place liquids directly on the glass. They might seep and damage the device.

3. Clean the scanner strip by using a soft cloth or sponge that has been moistened with nonabrasive glass cleaner.



**Figure 3-4.** Cleaning the LJ 3020 and 3030 glass (2 of 2)

4. To prevent spotting, dry the glass by using a chamois or cellulose sponge.
5. Plug the product in and use the power switch to turn on the product.

### Cleaning the LJ 3020 and 3030 lid backing

Debris can accumulate on the white document lid backing that is located underneath the device lid.

1. Use the power switch to turn off the device, unplug the power cord from the electrical socket, and raise the lid.

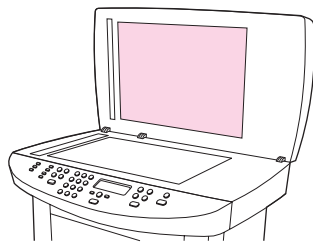
---

**Note**

---

Turn the power switch to the off position.

2. Clean the white document lid backing by using a soft cloth or sponge that has been moistened with a mild soap and warm water.



**Figure 3-5.** Cleaning the LJ 3020 and 3030 lid backing

3. Wash the backing gently to loosen debris; do not scrub the backing.

4. Dry the backing by using a chamois or soft cloth.

---

**CAUTION**

Do not use paper-based wipes because they might scratch the backing.

5. Plug the product in and use the power switch to turn on the product.
6. If this procedure does not clean the backing thoroughly, repeat the previous steps but use isopropyl alcohol to dampen the cloth or sponge, and then wipe the backing thoroughly with a damp cloth to remove any residual alcohol.

## Cleaning the print-cartridge area

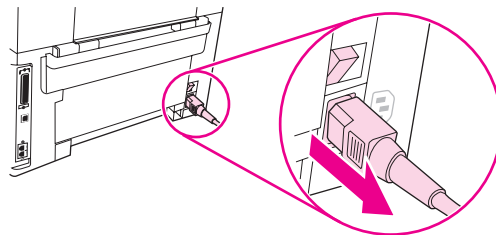
You do not need to clean the print-cartridge area often. However, cleaning this area can improve the quality of your printed sheets. During the printing process, paper, toner, and dust particles can accumulate inside the product. Over time, this buildup can cause print-quality problems, such as toner specks or smearing. To correct and prevent these types of problems, you can clean the print-cartridge area and the media path.

### To cleaning the print-cartridge area (all models)

#### **WARNING!**

Wait for the product to cool before beginning this procedure.

1. Use the power switch to turn the product off, and then unplug the power cord.



**Figure 3-6.**

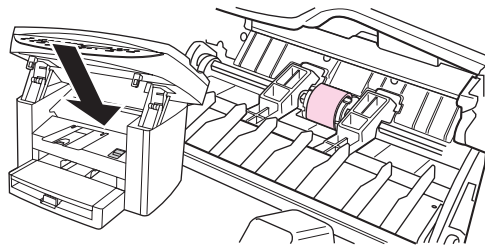
#### **Cleaning the print-cartridge area (1 of 3)**

2. Open the print-cartridge door, and remove the print cartridge.

#### **CAUTION**

To prevent damage, do not expose the print cartridge to light. Cover the print cartridge, if necessary. Do not touch the transfer roller (the black rubber roller located underneath the print cartridge). Skin oils on the roller can affect print quality.

3. Use a dry, lint-free cloth, or an HP toner cloth (part number 5090-3379) to wipe any residue from the paper-path area and the print-cartridge cavity.

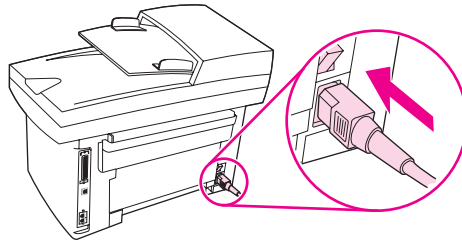


**Figure 3-7.**

#### **Cleaning the print-cartridge area (2 of 3)**

4. Replace the print cartridge, and close the print-cartridge door.

5. Plug the product in, and then use the power switch to turn on the product.



**Figure 3-8.** Cleaning the print-cartridge area (3 of 3)

---

**WARNING!**

---

Do not spray or use water inside the product. Failure to follow this warning can result in severe damage to the product or serious personal injury.

---

**Note**

---

If toner gets on your clothing or other fabric, wipe off the toner with a dry cloth. Wash the items in cold water and air-dry them. If toner gets on your hands, wash your hands in cold water. Hot water or heat from a dryer can set toner into fabric.

## Cleaning the printer pickup roller (all models)

If the product regularly picks up multiple sheets of media at one time or picks up no sheets at all, clean or replace the pickup roller. Before replacing the pickup roller, try to clean it. To clean the pickup roller, use the following instructions.

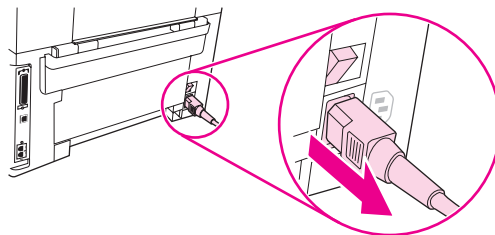
---

**Note**

---

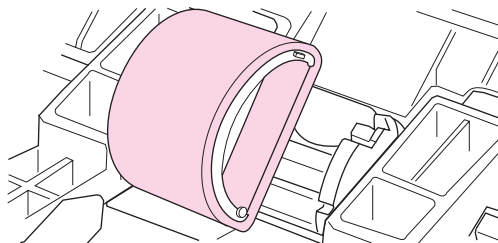
If the product does not pick up media from the tray, the cause is almost always a dirty or damaged pickup roller. If cleaning the pickup roller does not resolve the problem, replace the pickup roller. See [Printer pickup roller \(all models\)](#) for instructions.

1. Use the power switch to turn the product off and then unplug the power cord.



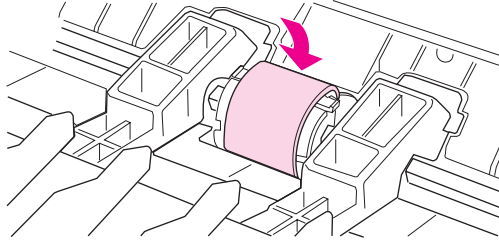
**Figure 3-9.** Cleaning the separation pad

2. Remove the pickup roller. See [Printer pickup roller \(all models\)](#).
3. Dampen a lint-free cloth with isopropyl alcohol, and scrub the roller.
4. Using a dry lint free cloth, wipe the pickup roller to remove loosened dirt.



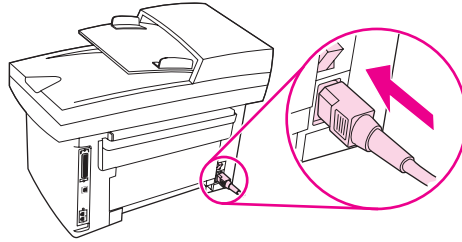
**Figure 3-10.** Cleaning the pickup roller (1 of 3)

5. Allow the pickup roller to dry completely before you reinstall it in the product. See steps 6 through 8 of [Printer pickup roller \(all models\)](#).



**Figure 3-11.** Cleaning the pickup roller (2 of 3)

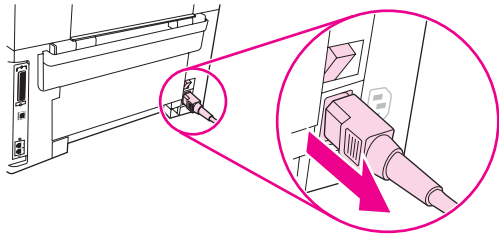
6. Plug the product in, and then use the power switch to turn on the product.



**Figure 3-12.** Cleaning the pickup roller (3 of 3)

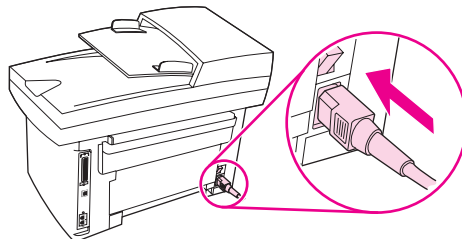
### Cleaning the printer separation pad (all models)

1. Use the power switch to turn the product off and then unplug the power cord.



**Figure 3-13.** Cleaning the separation pad (1 of 2)

2. Remove the separation pad. See [Printer separation pad \(all models\)](#).
3. Dampen a lint-free cloth with isopropyl alcohol, and scrub the separation pad.
4. Reinstall the separation pad. See steps 1 through 3 of [Printer separation pad \(all models\)](#)
5. Plug the product in, and then use the power switch to turn on the product.



**Figure 3-14.** Cleaning the separation pad (2 of 2)

## User replaceable parts

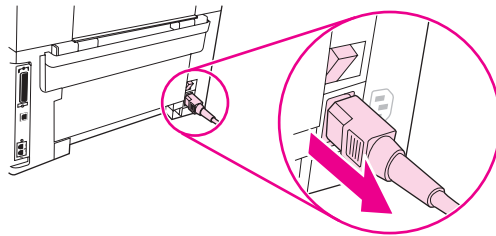
The following sections provide procedures that the user can follow to replace certain parts.

### Printer pickup roller (all models)

#### CAUTION

Failure to complete all of the steps in this procedure might damage the printer.

1. Use the power switch to turn the product off and then unplug the power cord.



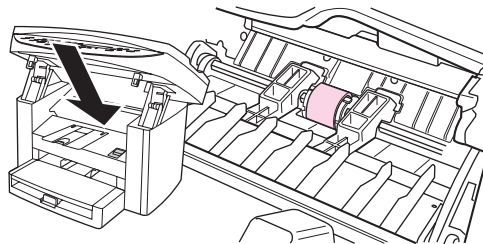
**Figure 3-15.** Replacing the pickup roller (1 of 7)

2. Open the print-cartridge door, and remove the print cartridge.

#### CAUTION

To prevent damage, do not expose the print cartridge to light. Cover the print cartridge or place it in a black plastic bag, if necessary. Also, do not touch the black-sponge transfer roller inside the product. Touching the transfer roller can damage the product.

3. Locate the pickup roller.

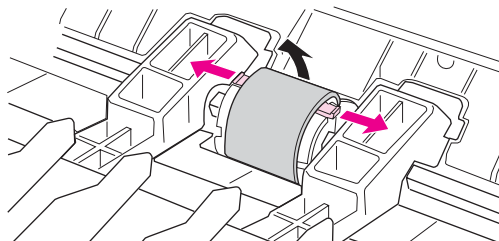


**Figure 3-16.** Replacing the pickup roller (2 of 7)

4. Gently release the small, white tabs on each side of the pickup roller by pushing them away from the roller, and then rotate the pickup roller toward the front.

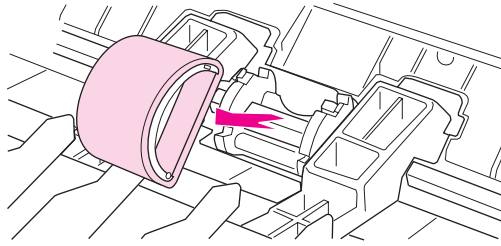
#### CAUTION

Use gentle pressure to release the small white tabs to avoid breaking them.



**Figure 3-17.** Replacing the pickup roller (3 of 7)

5. Gently pull the pickup roller up and out.

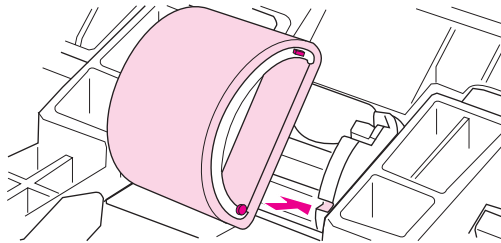


**Figure 3-18.** Replacing the pickup roller (4 of 7)

6. Position the cleaned or replacement pickup roller in the slots on the pickup roller frame.

**Hint**

Circular and rectangular pegs on each side prevent you from incorrectly positioning the pickup roller.

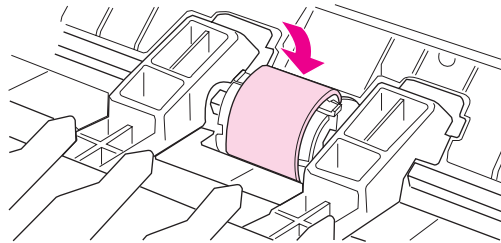


**Figure 3-19.** Replacing the pickup roller (5 of 7)

7. Rotate the top of the pickup roller into position until the white tabs on each side of the roller snap into place.

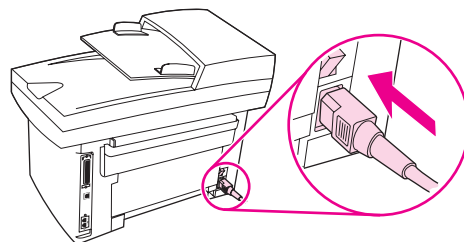
**Note**

Touching the transfer roller can damage the product.



**Figure 3-20.** Replacing the pickup roller (6 of 7)

8. Reinstall the print cartridge and close the print-cartridge door.
9. Plug the product in, and then use the power switch to turn on the product.



**Figure 3-21.** Replacing the pickup roller (7 of 7)



## Printer separation pad (all models)

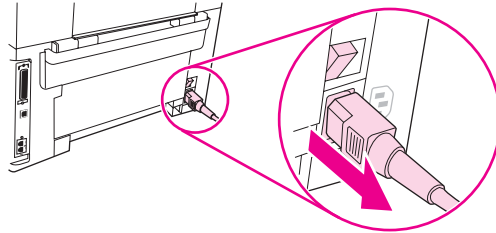
### Hint

Before changing the separation pad, clean the pickup roller. If the product continues to pick up more than one page at a time, replace the separation pad. See [Cleaning the printer pickup roller \(all models\)](#).

### Note

The following procedure requires a #2 Phillips screwdriver.

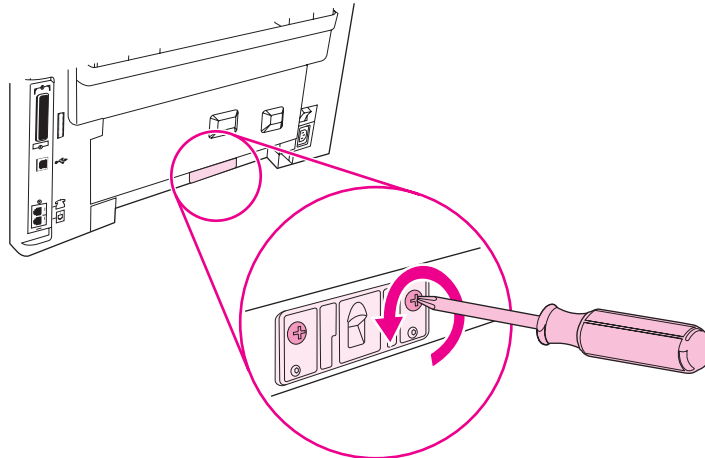
1. Use the power switch to turn the product off and unplug the power cord.



**Figure 3-22.**

### Replacing the printer separation pad (1 of 5)

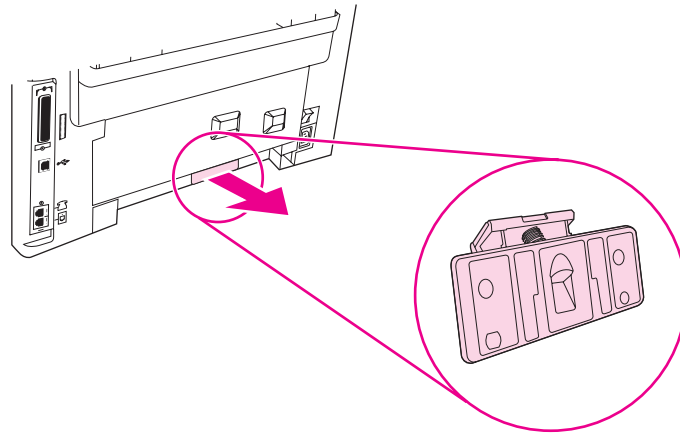
2. At the back of the product, unscrew the two screws that fasten the separation pad and frame to the product.



**Figure 3-23.**

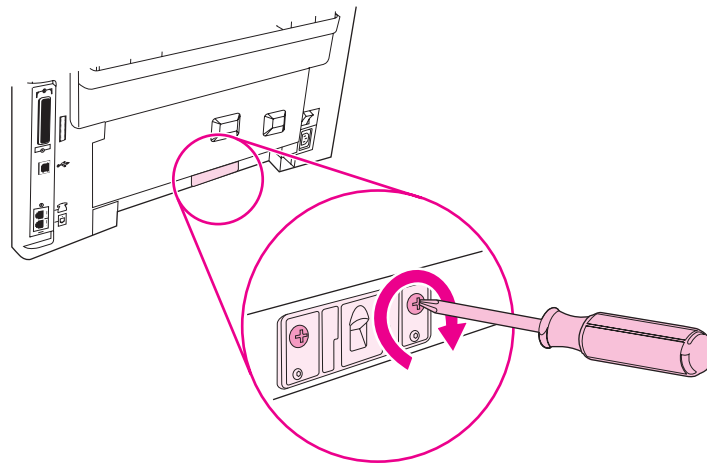
### Replacing the printer separation pad (2 of 5)

3. Remove the separation pad and frame.



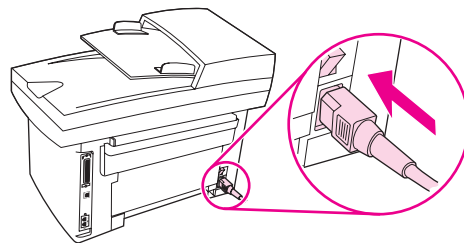
**Figure 3-24.** Replacing the printer separation pad (3 of 5)

4. Insert the replacement separation pad and frame and fasten it to the product with the two screws.



**Figure 3-25.** Replacing the printer separation pad (4 of 5)

5. Plug the product in, and then use the power switch to turn on the product.

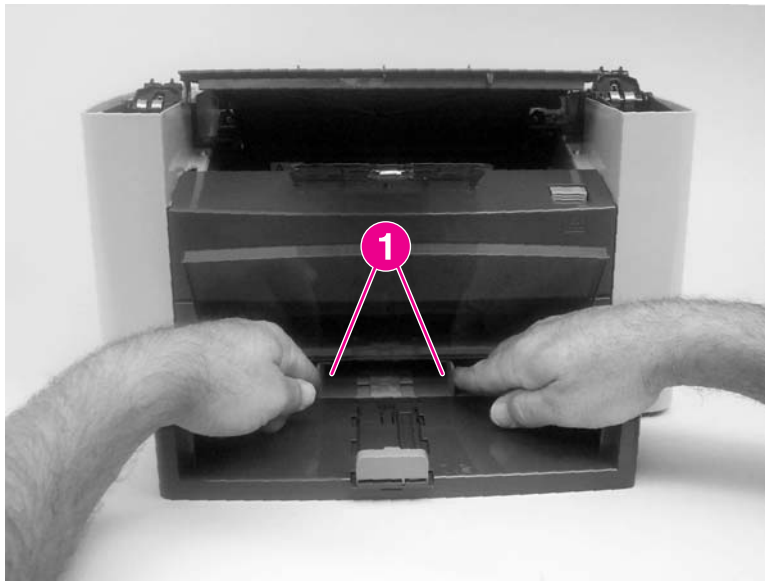


**Figure 3-26.** Replacing the printer separation pad (5 of 5)

## Printer main input tray (all models)

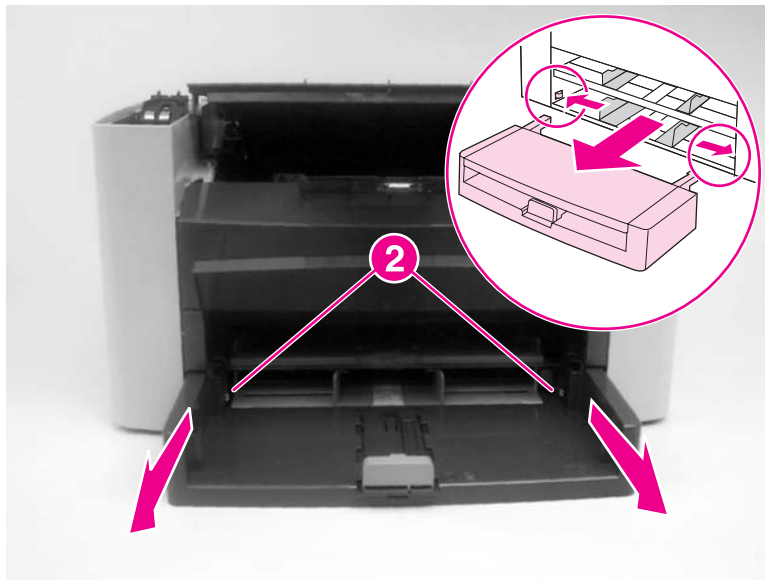
1. Open the media input tray lid.

- Slide the adjustable media guides (callout 1) to the center of the tray.



**Figure 3-27.** Remove the media input tray (1 of 2)

- Depress the tray locking tabs (callout 2), and then remove the tray.



**Figure 3-28.** Remove the paper pickup tray (2 of 2)

## HP LaserJet 3015 ADF pickup roller

---

### WARNING!

---

The HP LaserJet 3015 ADF pickup roller *is not* a user replaceable assembly. Only trained service personnel should attempt to replace the LJ 3015 pickup roller. See [Pickup roller](#) in chapter 5.

## HP LaserJet 3015 ADF separation pad set

### Note

The *separation pad set* and the *separation pad assembly* are two different assemblies.

The separation pad set consists of the pad, clear plastic sheet, and the pad cover. The separation pad set *is* a user replaceable assembly.

The separation-pad assembly consists of the separation lever, tension spring, feed arm, and the components of the separation pad set. The separation-pad assembly *is not* a user replaceable assembly.

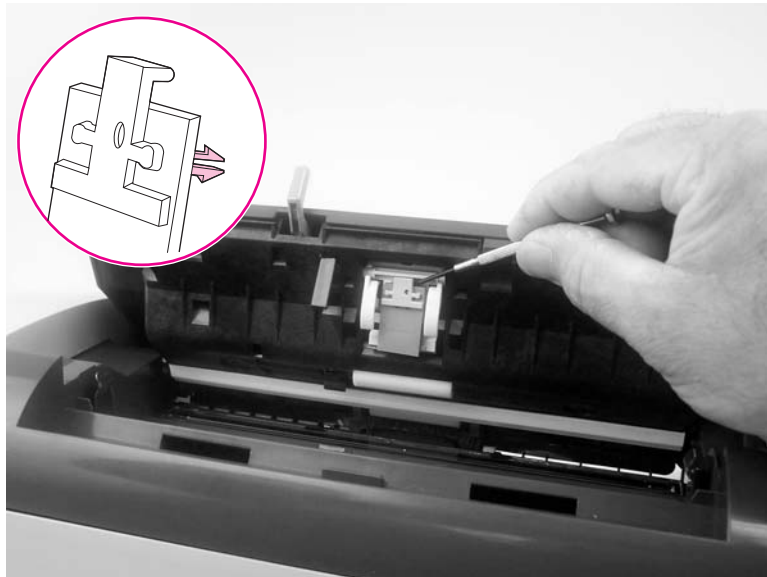
Only trained service personnel should attempt to replace the separation-pad assembly.

1. Use the power switch to turn the product off and unplug the power cord.
2. Open the scanner top cover.
3. Carefully push the replacement separation pad set onto the guide assembly. Close the ADF lid.

### CAUTION

When installing the replacement pad, be careful not to bend or break the retainer-clip pins.

Do not touch the grey separation pad. Skin oils and fingerprints on the separation pad might cause paper-feed problems.



**Figure 3-29.**

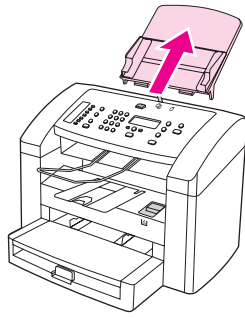
### Remove the separation pad

4. Plug the product in, and then use the power switch to turn on the product.

## HP LaserJet 3015 ADF input tray

1. Rotate the ADF input tray toward the front of the product.

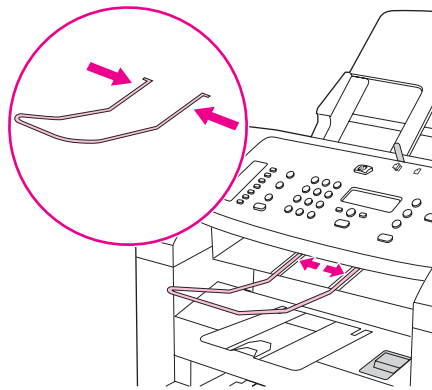
2. Lift the tray up and off of the product.



**Figure 3-30.** Replacing the ADF input tray

## HP LaserJet 3015 ADF output bin

1. Flex the wire ADF output tray until it fits into the slots on the ADF.
2. Release the output tray, and then verify that the ends of the tray are seated in the holes in the ADF.

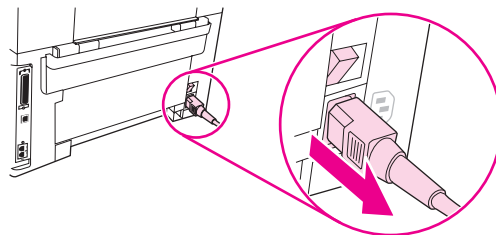


**Figure 3-31.** Replacing the ADF output bin

## HP LaserJet 3020 and 3030 ADF pickup roller

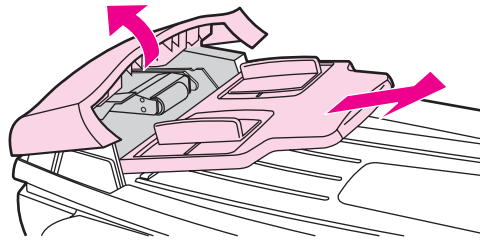
If the ADF has trouble picking paper, see [Troubleshooting](#) to try to resolve the problem. If necessary, replace the ADF pickup roller assembly. To remove the existing assembly, follow these instructions.

1. Use the power switch to turn off the product, and then unplug the power cord.



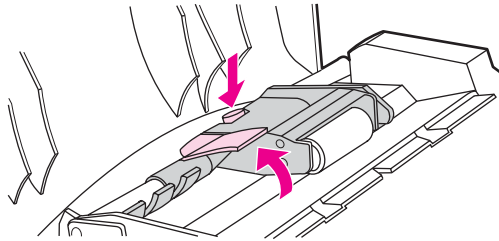
**Figure 3-32.** Replacing the ADF pickup-roller assembly (1 of 9)

2. Remove the input tray and open the ADF cover.



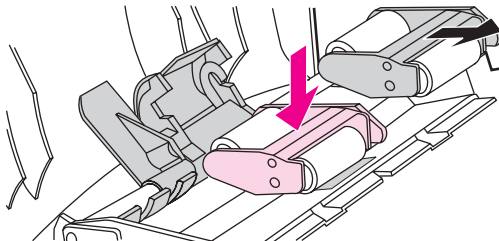
**Figure 3-33.** Replacing the ADF pickup-roller assembly (2 of 9)

3. Press the round, green button while lifting the green lever. Rotate the green lever until it stops in the open position. The old pickup roller assembly should remain on the black surface.



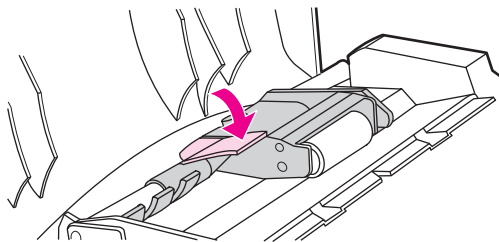
**Figure 3-34.** Replacing the ADF pickup-roller assembly (3 of 9)

4. Remove the old assembly and put the new one in exactly the same place. The largest roller goes in back, and the gear side is away from you.



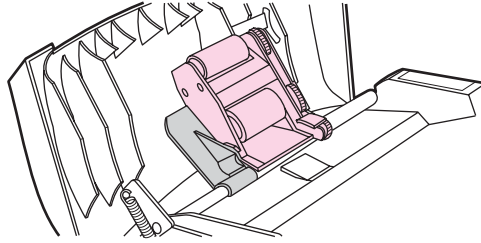
**Figure 3-35.** Replacing the ADF pickup-roller assembly (4 of 9)

5. Lower the green lever so that the flat green part fits between the rollers. Press down on the green lever until you hear it snap into place.



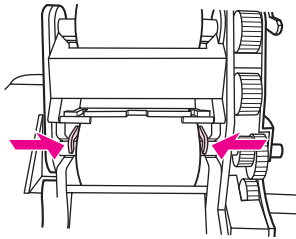
**Figure 3-36.** Replacing the ADF pickup-roller assembly (5 of 9)

- To check for proper installation, lift the green lever until it remains in the open position. The new pickup roller assembly should be secured to the lever assembly and should not fall out.



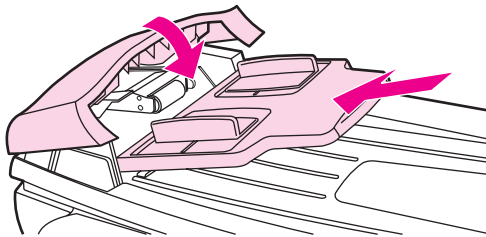
**Figure 3-37.** Replacing the ADF pickup-roller assembly (6 of 9)

- Make sure that both sides of the assembly are secured by the green hooks.



**Figure 3-38.** Replacing the ADF pickup-roller assembly (7 of 9)

- Lower the green lever assembly and close the ADF lid. Reinstall the input tray.

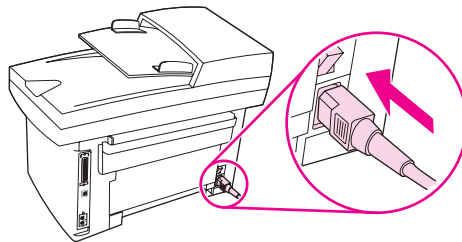


**Figure 3-39.** Replacing the ADF pickup-roller assembly (8 of 9)

**Note**

If you are experiencing jams in the ADF, see [Troubleshooting](#).

- Plug the product in, and then use the power switch to turn on the product.



**Figure 3-40.** Replacing the ADF pickup-roller assembly (9 of 9)

## HP LaserJet 3020 and 3030 ADF separation pad

### CAUTION

Avoid touching the flatbed glass or the ADF separation pad. Skin oils and fingerprints can contaminate the glass or pad and cause print quality or paper pickup problems.

1. Use the power switch to turn the product off and unplug the power cord.
2. Open the ADF cover and lift up the ADF pickup-roller assembly.
3. Use a #8 torx screwdriver to remove two torx screws (callout 1) and remove the separation-pad assembly.

### CAUTION

When installing the replacement pad, be careful not to bend or break the retainer-clip pins.

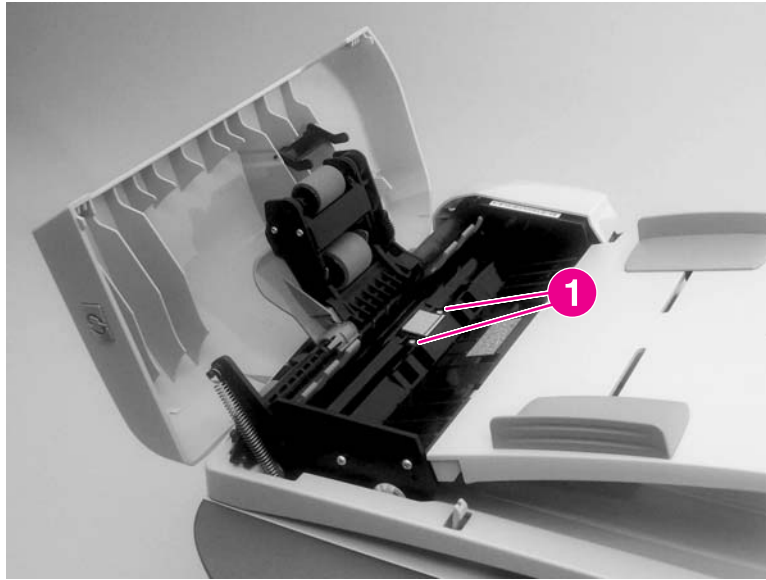


Figure 3-41.

### Remove the separation pad

4. Install the replacement ADF separation-pad assembly. Close the ADF lid.
5. Plug the product in, and then use the power switch to turn on the product.

## HP LaserJet 3020 and 3030 control-panel bezel

1. Use the power switch to turn off the product, and then unplug the power cord.

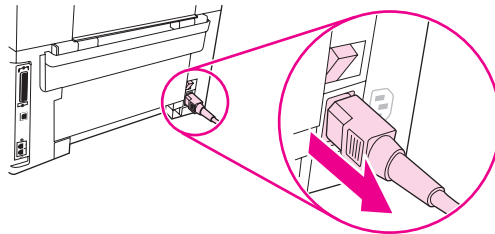
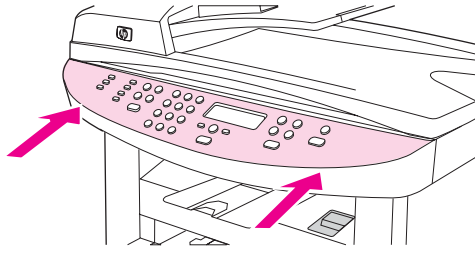


Figure 3-42.

### Replacing the control-panel bezel (1 of 4)



2. Gently pry up the outside edge of the control-panel bezel to remove it.



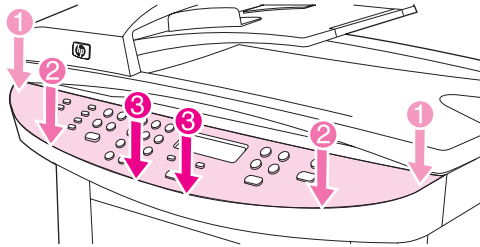
**Figure 3-43.**

**Replacing the control-panel bezel (2 of 4)**

**CAUTION**

Be careful not to touch any components or buttons inside the exposed product control-panel area.

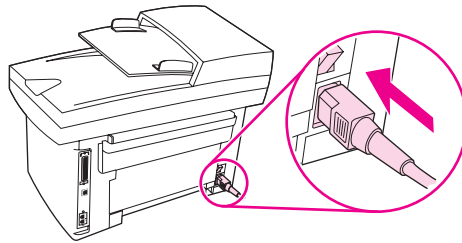
3. Position the replacement bezel over the control panel. Working from the outside corners towards the middle of the bezel, push down until the bezel snaps into place.



**Figure 3-44.**

**Replacing the control-panel bezel (3 of 4)**

4. Plug the product in, and then use the power switch to turn on the product.



**Figure 3-45.**

**Replacing the control-panel bezel (4 of 4)**



# 4

## Operational overview

This chapter contains information about the following topics.

Basic functions (all models) .....	70
Basic sequence of operation .....	71
Formatter system .....	75
Central processing unit .....	75
Line interface unit (HP LaserJet 3015 and 3030 only) .....	75
Standard boot process .....	75
RAM .....	76
Parallel interface or universal serial bus (USB) interface .....	76
Control panel .....	76
EconoMode .....	76
MEt .....	77
Enhanced I/O .....	77
PJL overview .....	77
Printer functions (all models).....	78
Engine control system (engine control unit and power-supply assembly).....	78
Image-formation system.....	83
Print cartridge.....	84
Printer paper-feed system.....	84
Jam detection in the printer .....	85
HP LaserJet 3015 all-in-one unique components.....	87
Basic operation.....	87
HP LaserJet 3020 and 3030 all-in-one unique components.....	93
Scanner and ADF functions and operation .....	93
Fax functions and operation (HP LaserJet 3015 and 3030 only) .....	96
PSTN operation .....	96
The fax subsystem .....	96
Formatter in the fax subsystem .....	96
LIU in the fax subsystem .....	96
Fax page storage in flash memory .....	99

## Basic functions (all models)

This chapter presents a functional overview of the HP LaserJet 3015, 3020, and 3030 all-in-one products. The following systems are discussed:

- printer functions and operation
  - engine controller unit (ECU) system/power system
  - laser/scanner system
  - image-formation system
  - paper-feed system (printer) and document-feed system (document scanner)
- formatter functions
- scanner and ADF functions and operation
- fax functions and operation (HP LaserJet 3015 and 3030 only)

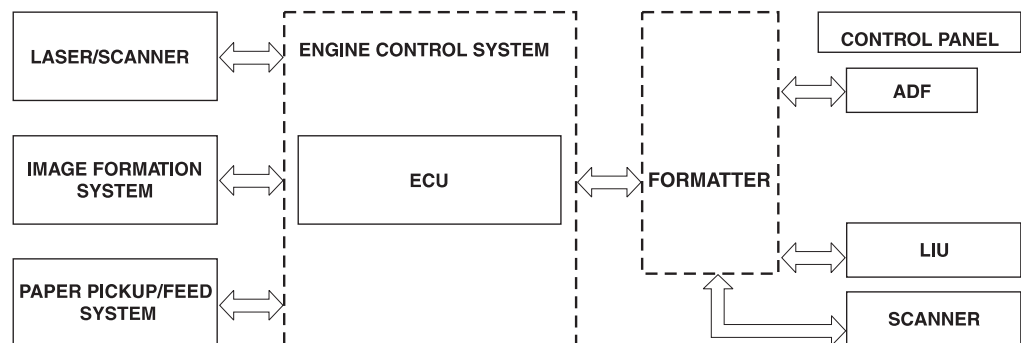
The full product consists of the following components:

- the scanner and ADF
  - the HP LaserJet 3015 uses a fixed contact image scanner (CIS)
  - the HP LaserJet 3020 and 3030 use a flatbed charged-coupled device (CCD)
- the printer
- the formatter
- the line interface unit (LIU) (HP LaserJet 3015 and 3030 only)

Each of these systems brings its own characteristic functionality to the product: scanning, printing, and telecommunications (HP LaserJet 3015 and 3030 only), respectively. These systems interact to provide copying and faxing capability (only the HP LaserJet 3015 and 3030 have faxing capability).

- The scanner and printer work together to make copies.
- The scanner and LIU work together to send faxes (HP LaserJet 3015 and 3030 only).
- The LIU and printer work together to receive faxes (HP LaserJet 3015 and 3030 only).

The ECU controls the operation sequences of the printer. The formatter controls the operation sequences of the LIU (HP LaserJet 3015 and 3030 only) and document scanner.



**Figure 4-1.** Product configuration

## Basic sequence of operation

The microprocessor (CPU) on the ECU controls the operation sequence of the printer. The following events take place during normal printer operation:

**Table 4-1. HP LaserJet 3015 basic sequence of operation**

Period	Purpose	Remarks
WAIT. After the product is turned on until <b>READY</b> appears on the control-panel display.	To perform the firmware initialization.	Tests RAM and establishes and communication with the control panel.
READY. From the end of the WAIT period until the user initiates action or a fax is received.	To keep the product ready to print, copy, scan, or fax.	
CALIBRATION. From the time the copy, scan, or fax button is pressed until the STAGE period.	To compensate for variables in the scanning system.	This occurs before media moves past the scanner.
STAGE. From the end of the CALIBRATION period until the SCAN period.	To position the leading edge of the original document at the scanning position.	The page feeds partway into the scanner, and then briefly stops.
SCAN. From the end of the brief pause during the STAGE period until the EJECT or following-page STAGE period.	To scan one page of the original document.	Another STAGE period follows if another page of the original document is present in the ADF. Otherwise, the EJECT period begins.
EJECT. From the end of the SCAN period until the original document page is completely ejected from the scanner.	To clear the last page of the original document from the scanner.	The product returns to the READY period at the end of the EJECT period.

**Table 4-2. HP LaserJet 3020 and 3030 basic sequence of operation**

Period	Purpose	Remarks
WAIT. After the product is turned on until the message <b>Scanner Bulb warming up</b> appears on the control-panel display.	To perform the firmware initialization.	Tests RAM and establishes communication with the control panel.
AMBIENT LIGHT DETECT. From the end of the WAIT period until the scanner bulb is turned on.	To determine the level of ambient light in the environment.	The scanner makes a short move toward the ADF. If ambient light is too bright, the scanner moves away from the ADF until it is under the bezel (in shadow). At the end of this period, the scanner bulb is turned on.

**Table 4-2. HP LaserJet 3020 and 3030 basic sequence of operation (continued)**

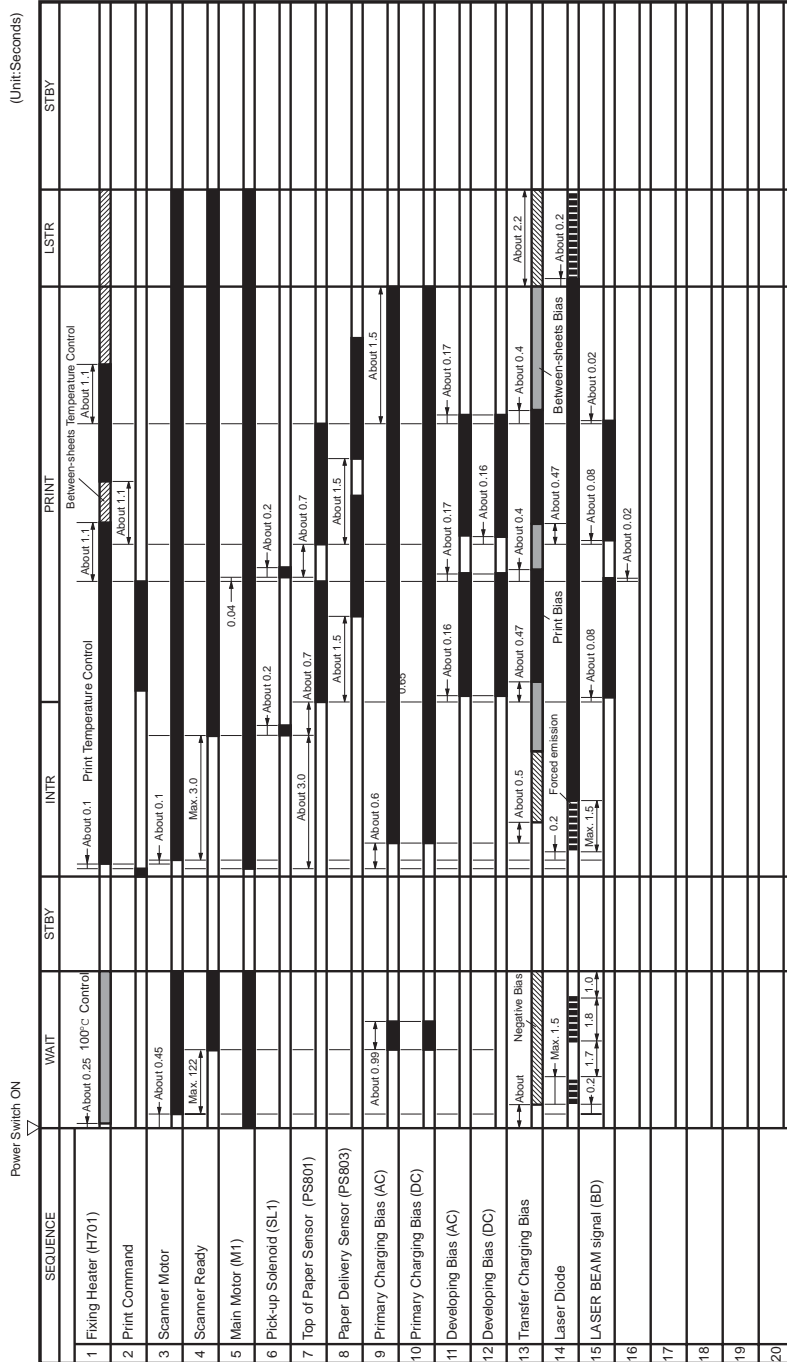
Period	Purpose	Remarks
INITIAL WARMUP. From the end of the AMBIENT LIGHT DETECT period until the scanner begins moving.	To warm up the scanner bulb.	The length of this period varies depending on product age and environmental conditions. However, this period will timeout (end) if the scanner bulb does not warm up within 2 minutes, and an error message appears on the control panel.
HOME FIND. From the end of INITIAL WARMUP until the <b>Ready</b> message appears on the control-panel display.	To position the scanner at the home position under the bezel at the document-origin end of the flatbed, and to perform the final lamp warmup checks.	The scanner performs several back-and-forth movements during this period. The scanner finds its home position by scanning, not by using any sort of sensor.
READY. From the end of HOME FIND until the STANDBY period.	To keep the product ready to print, scan, copy, or fax with no scanner warmup delay.	The scanner remains in the READY state for 10 minutes following HOME FIND or following the last scanner usage.
STANDBY. Occurs 10 minutes after the start of the READY period, or 10 minutes after the last scanner usage (copy/scan/fax).	To reduce power consumption and increase scanner bulb life.	The scanner performs a HOME FIND before going into standby.
POWERSAVE. Occurs a minimum of 2 hours and a maximum of 12 hours (user configurable) after the start of the READY period, or after the last scanner usage.	To reduce power consumption and increase scanner-bulb life beyond what can be achieved with STANDBY.	A workday modeling algorithm governs the actual powersave behavior.
CALIBRATION. From the time the copy/scan/fax button is pressed until the STAGE period.	To compensate for variability in the scanning system.	Calibration is performed by moving the scanner back-and-forth several times near the home position. If the previous period was STANDBY or POWERSAVE, a short delay occurs. The message <b>Scanner Bulb warming up</b> appears on the control-panel display during this delay.
STAGE. From the end of CALIBRATION until the SCAN period.	<p>For an ADF scan: to position the scanner under the ADF scanning window, and then to position the original document's leading edge at the scanning position.</p> <p>For a flatbed scan: to position the scanner at the document-origin position before scanning the original.</p>	<p>For an ADF scan, the page feeds partway into the scanner, then stops briefly.</p> <p>For a flatbed scan, the STAGE period is built-in to the SCAN period, so STAGE is not visible externally.</p>

**Table 4-2. HP LaserJet 3020 and 3030 basic sequence of operation (continued)**

Period	Purpose	Remarks
<p>SCAN.</p> <p>For an ADF scan: From the end of the brief pause that follows the STAGE period until the EJECT or following-page STAGE period.</p> <p>For a flatbed scan: From the end of CALIBRATION until the REHOME period.</p>	To scan one page of the original document.	<p>For an ADF scan: another STAGE period follows this period if another page of the original document is present in the ADF. Otherwise, the EJECT period follows.</p> <p>For a flatbed scan: The REHOME period follows this period.</p>
EJECT. (ADF only) From the end of the SCAN period until the original document page is completely ejected from the scanner.	To clear the last page of the original document from the scanner.	
REHOME. From the end of the EJECT period (ADF) or the SCAN period (flatbed) until the <b>Ready</b> message appears on the control-panel display.	To return the scanner to the home position.	A short back-and-forth sequence occurs as the scanner reaches the home position before the <b>Ready</b> message appears on the control-panel display.

**Table 4-3. HP LaserJet 3015, 3020 and 3030 printer (product base) basic sequence of operation**

Period	Purpose	Remarks
WAIT After the product is turned on until the end of the initial rotation of the main motor.	To clear the drum surface of potential and to clean the primary charging roller.	Detects whether or not the cartridge is installed.
STBY (Standby) From the end of the WAIT period or the LSTR period until the pickup command is sent from the formatter. Or, from the end of the LSTR period until the product is turned off.	To pause until the product is ready to print.	
INTR (Initial Rotation Period) After the pickup command has been sent from the formatter until the media reaches the top-of-page sensor (PS801).	To stabilize the photosensitive drum sensitivity in preparation for printing. Also to clean the primary charging roller.	
PRINT (Print) From the end of the initial rotation until the primary voltage goes OFF.	To form images on the photosensitive drum based on the VIDEO signals (VDO, VDO) sent from the formatter and to transfer the toner image onto the media.	
LSTR (Last Rotation Period) After the primary voltage goes OFF until the main motor stops rotating.	To deliver the last page. Also to clean the primary charging roller.	When the pickup command is sent from the video controller, the printer enters the INTR period immediately after the end of the LSTR period.



**Figure 4-2. HP LaserJet 3015, 3020, and 3030 printer (product base) timing diagram**



## Formatter system

The formatter coordinates the major systems. It is responsible for the following tasks or actions:

- formatting and controlling copies
- receiving and processing print data from the printer interface
- monitoring the control panel and relaying printer-status information
- developing and coordinating data placement and timing with the print engine
- communicating with the host computer through the bidirectional interface
- communicating fax data to and from the LIU (HP LaserJet 3015 and 3030 only)

The formatter receives print data from the bidirectional enhanced capabilities port (ECP) mode interface or universal serial bus (USB) interface and converts it into a dot image. The ECU synchronizes the image-formation system with the paper-feed system and signals the formatter to send the print-image data. The formatter sends the print-image data (dots) in the form of a video signal, and the printing process begins.

### Central processing unit

The formatter incorporates an embedded Coldfire V4 processor operating at 133 MHz.

### Line interface unit (HP LaserJet 3015 and 3030 only)

The line interface unit (LIU) provides the required safety isolation, signal coupling, and impedance matching between the telephone line and the modem chipset that is located on the formatter.

### Standard boot process

When the product is unplugged or the power is off, the firmware code is stored on the formatter in two blocks. The first block of code is an executable boot block (about 64 K of code). The second block of code is a compressed version of the product control code.

When the product is turned on, the boot block decompresses the product control code and stores it in RAM. Then the product performs a full startup with the control code running from RAM.

### Product startup messages

The LED display contains different messages depending upon the progress of the boot process:

**Table 4-4. Product startup messages**

Message	Cause	Solution
-blank-	(Blank display for many seconds after power-on.) Boot-block failure.	Use the power switch to turn the power to the product off. Check all wire-harness connectors and FFCs to make sure that they are firmly connected.  Replace the formatter. See <a href="#">Formatter and line interface unit (LIU)</a> .
<b>Contact Service</b>	Control-code failure.	Replace the formatter. See <a href="#">Formatter and line interface unit (LIU)</a> .
<b>Hewlett Packard</b> <<< [Moving-cursor HP display.]	The product is starting up.	Wait for the <b>Ready</b> message.
<b>Ready</b> .....	Product startup is complete and the product is ready for use.	Begin using the product.

## RAM

The product contains two types of random-access memory (RAM):

- One bank of nonvolatile RAM (NVRAM) stores parameters.
- Dynamic random access memory (DRAM) provides temporary storage of the product program code along with copy, scan, and print data.

## Parallel interface or universal serial bus (USB) interface

The formatter receives incoming data through its bidirectional ECP or USB interface. These interfaces provide high-speed, two-way communication between the product and the host, allowing you to change product settings and monitor product status from the host computer.

## Control panel

The control panel consists of the following features:

- groups of buttons to control fax, copy, scan, and configuration functionality (only the HP LaserJet 3015 and 3030 have fax capability)
- a 2-by-16 LCD display that shows status, menus, and messages
- front-panel status lights
  - the HP LaserJet 3015 and 3030 have three LED status lights
  - the HP LaserJet 3020 has two LED status lights

## EconoMode

When you select EconoMode (draft) in the printer driver, the product uses less toner, which extends the life of the print cartridge.

---

**Note**

---

When using EconoMode image quality (both clarity and contrast) will be considerably decreased because less toner is applied to the page.

## MEt

HP Memory Enhancement technology (MEt) effectively doubles the standard memory through a variety of font- and data-compression methods.

## Enhanced I/O

The enhanced I/O (EIO) feature allows product memory to be used for storing data received from the host computer. When EIO is enabled, you can send more data to the product in shorter amounts of time, so that you can return to the software program more quickly. The EIO feature has the following options:

- **Auto** —the product uses EIO memory allocation to increase the speed of data transfer from the host computer to the product, if necessary. The default setting is Auto.
- **Off** —the minimum amount of product memory is used to store data that is sent from the host computer.
- **Page Protect**—the formatter creates the entire page image in page-buffer memory before physically moving the media through the printer. This process ensures that the entire page will be printed.

Page complexity (ruling lines, complex graphics, or dense text) can exceed the printer's ability to create the page image fast enough to keep pace with the image-formation process. If Page Protect is disabled and a page is too complex, the page might print in sections (for example, the top half on one page and the bottom half on the next page). Some print-data loss is likely in these instances, and an error message will appear on the control-panel display.

## PJL overview

Printer job language (PJL) is an integral part of configuration, in addition to the standard printer command language (PCL). With standard ECP cabling, the product can use PJL to perform the following functions:

- **Two-way communication** with the host computer through a bidirectional parallel connection. The product can communicate information to the host (such as the control-panel status).
- **Isolation of print environment settings** from one print job to the next. For example, if a print job is sent to the product in landscape mode, the subsequent print jobs print in landscape only if they are formatted for landscape printing.

## Printer functions (all models)

Printer functions are divided into five groups:

- engine control
- formatter
- image formation
- laser/scanner
- pickup and feed

The following figure is a block diagram of the printer:

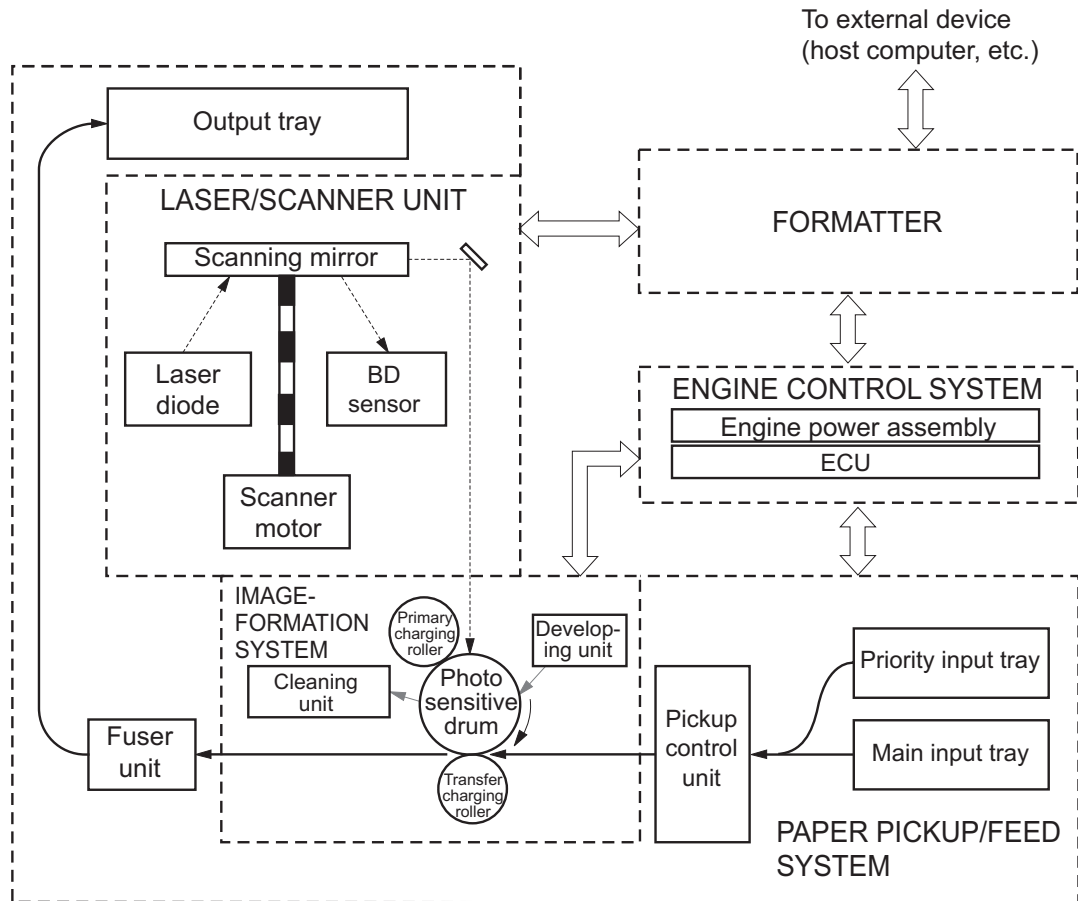


Figure 4-3. Printer functional block diagram

### Engine control system (engine control unit and power-supply assembly)

The engine control system coordinates all print engine activities. The engine control system includes both the engine control unit (ECU) printed circuit assembly (PCA) and the power-supply assembly PCA.

---

**Note**

---

In other HP LaserJet products, the ECU and power functions are combined onto one PCA known as the controller PCA or the DC controller PCA. In the HP LaserJet 3015, 3020, and 3030, the control functions are primarily relegated to the ECU PCA and the power functions to the power-supply assembly PCA.

The ECU controls the following systems and functions:

- **Printer engine control**
  - paper-motion monitoring and control (printing)
  - motor
- **Printer laser/scanner unit**

The power-supply assembly provides the following functions to the power system:

- ac power distribution
- dc power distribution
- overcurrent/overvoltage protection
- high-voltage power distribution

### **Printer engine control system**

**Paper motion monitoring and control.** The ECU controls paper motion in the printer by continuously monitoring the two paper sensors and coordinating the timing with the other print processes.

**Motor.** The ECU controls the motor. The motor drives all of the printer paper movement.

## Printer laser/scanner unit

The ECU sends signals to the laser/scanner assembly to modulate the laser-diode on and off modes and to drive the laser/scanner motor.

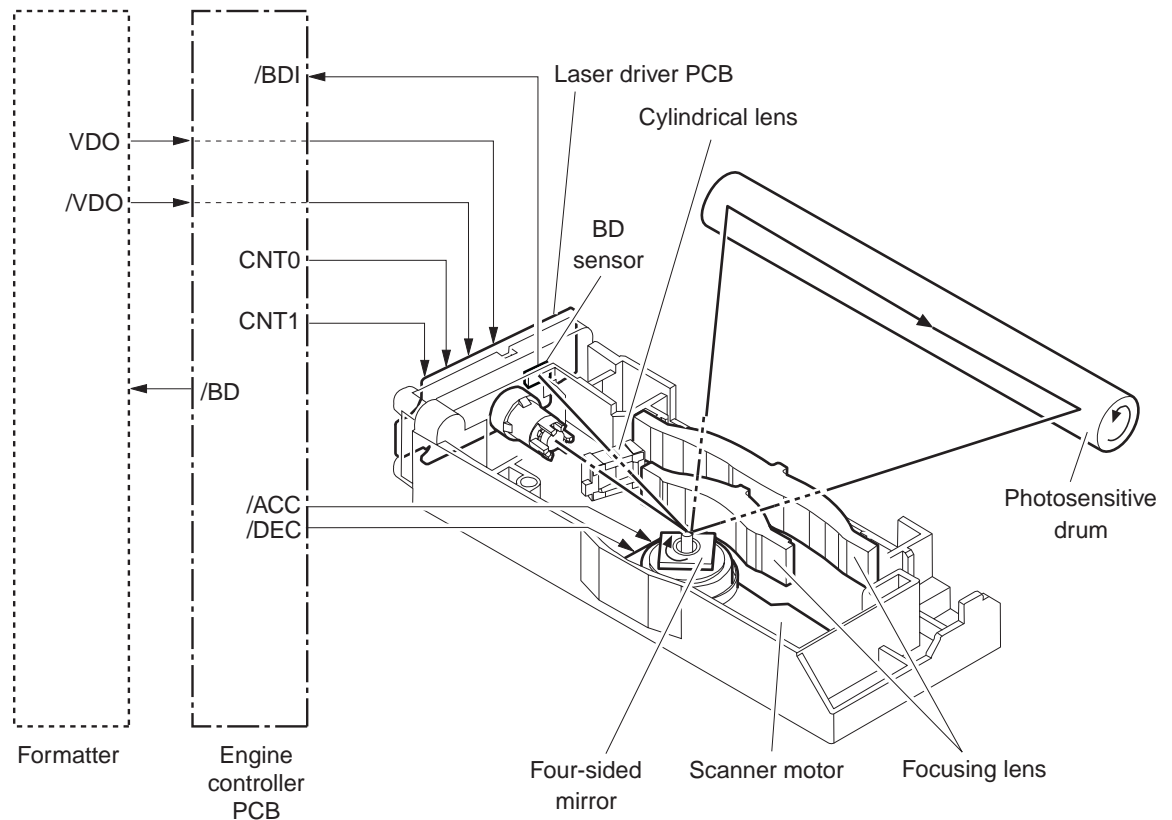


Figure 4-4.

### Laser/scanner operation

## Power system on the power-supply assembly

The ac, dc, and high-voltage power supply circuits are all provided by the power-supply assembly.

### Ac power distribution

The ac power circuitry supplies ac voltage whenever the power cord is connected to the ac power source and the power switch is on. The ac voltage is distributed to the dc power supply circuitry and to the ac driver circuitry, which controls ac voltage to the fuser assembly heating element.

### Dc power distribution

The dc power distribution circuitry, located on the engine power assembly, distributes +3.3 Vdc, +5 Vdc, and +24 Vdc as follows:

Table 4-5. Dc power distribution

+3.3 Vdc	ECU, sensors, formatter
+5 Vdc	Parallel interface on the 1015 formatter

**Table 4-5. Dc power distribution (continued)**

+24 Vdc	Main motor, laser/scanner motor, solenoid, high-voltage power supply, fuser, safety circuit, door switch
---------	--

**Overcurrent/overvoltage**

There are two overvoltage devices in this product:

- Fuse F101 provides overcurrent protection for the fusing system circuitry.
- Fuse F102 (110 V products only) provides overcurrent protection to the printer dc power supply circuitry.

You can check or replace the fuses by removing the left cover.

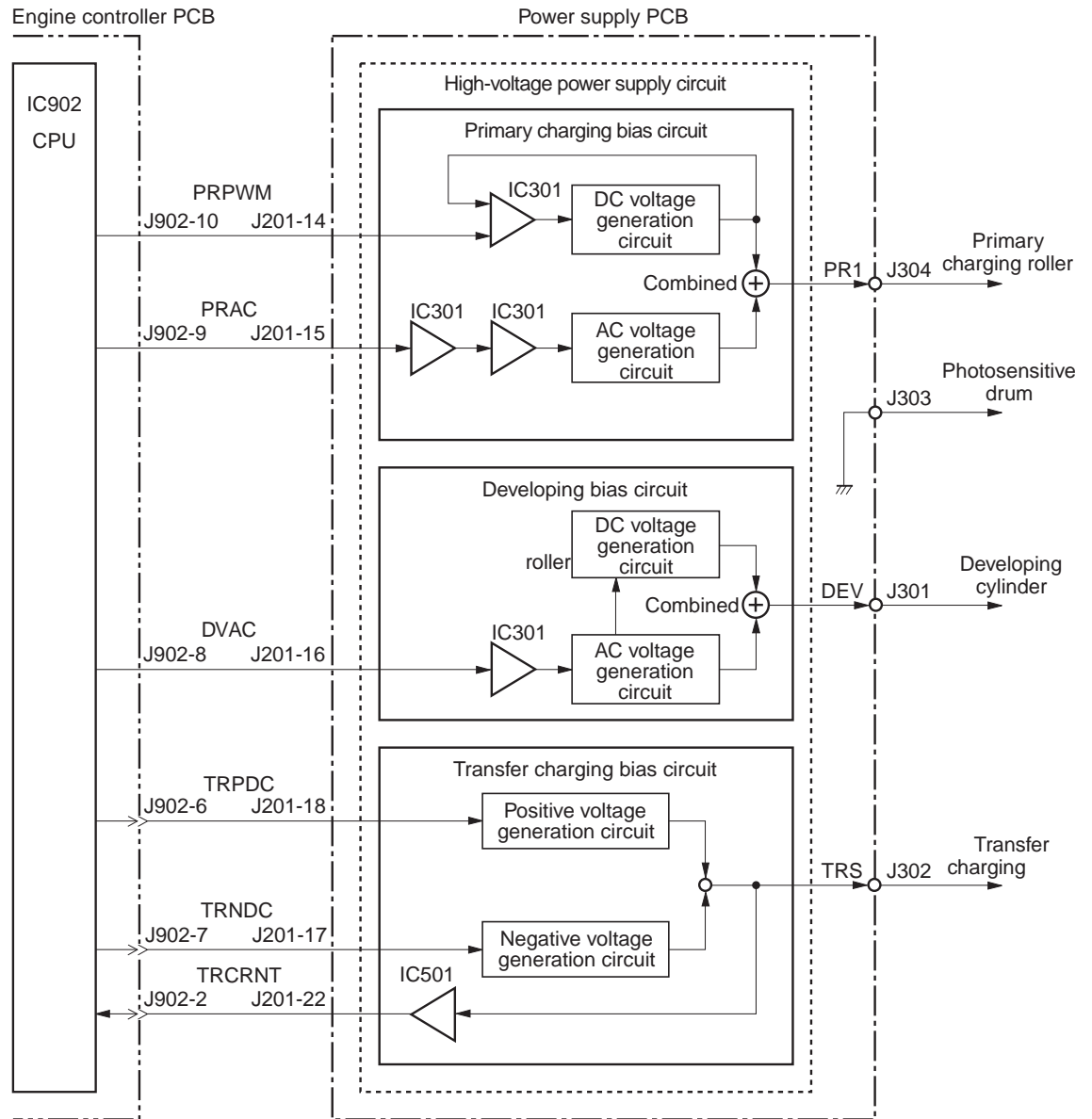
**Note**

If either of these fuses fail, replace the engine power supply. See [Power supply](#).

**High-voltage power distribution**

The high-voltage power supply applies an overlap of dc and ac voltage to the primary charging roller and to the developing roller. This circuit also applies a positive or negative dc voltage to the transfer roller according to the instructions from the engine control unit.

This circuit also controls the image density by changing the primary ac voltage and the developing ac bias according to the print density setting (which is set by using the HP Toolbox). High voltage is disabled when the print-cartridge door is open. The following [Figure 4-5. High-voltage power supply circuit](#) figure shows this process.



**Figure 4-5.** High-voltage power supply circuit



## Image-formation system

Laser printing requires the interaction of several different technologies including electronics, optics, and electrophotographics to provide a printed page. Each process functions independently and must be coordinated with the other printer processes. Image formation consists of seven processes:

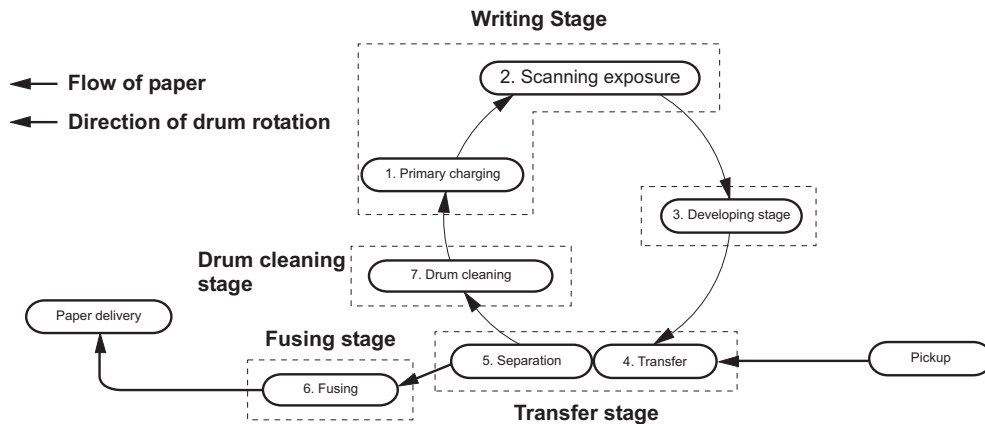


Figure 4-6. Image-formation block diagram

### The seven image-formation processes

- 1. Conditioning stage (primary charging)**—This process applies a uniform negative charge to the surface of the drum with the primary charging roller, which is located in the print cartridge. The primary charging roller is coated with conductive rubber. An ac bias is applied to the roller to erase any residual charges from any previous image. In addition, the primary charging roller applies a negative dc bias to create a uniform negative potential on the drum surface. The print density setting modifies the dc voltage.
- 2. Writing stage (scanning exposure)**—During this process, a modulated laser diode projects the beam onto a rotating scanning mirror. As the mirror rotates, the beam reflects off the mirror, first through a set of focusing lenses, then off a mirror, and finally through a slot in the top of the print cartridge, and onto the photosensitive drum. The beam sweeps the drum from left to right, discharging the negative potential wherever the beam strikes the surface. This creates a latent electrostatic image, which later is developed into a visible image. Because the beam sweeps the entire length of the drum while the drum rotates, the entire surface area of the drum can be covered. At the end of each sweep, the beam strikes the beam-detect lens, generating the beam-detect signal (BD signal). The BD signal is sent to the ECU where it is converted to an electrical signal used to synchronize the output of the next scan line of data.
- 3. Developing stage**—During this process, the latent electrostatic image is present on the drum. The toner particles obtain a negative surface charge by rubbing against the developing cylinder, which is connected to a negative dc supply. The negatively charged toner is attracted to the discharged (exposed, grounded) areas of the drum, and it is repelled from the negatively charged (unexposed) areas.
- 4. Transfer stage**—During this process, the toner image on the drum surface is transferred to the media. The transfer roller applies a positive charge to the back of the media, which attracts the negatively charged toner on the drum surface to the media. After separation, the drum is cleaned and conditioned for the next image.
- 5. Separation stage**—During this process, the media separates from the drum. To stabilize the feed system and prevent toner dropouts on the printed image at low temperature and humidity, the static eliminator reduces the charge on the back of the media.

6. **Fusing stage**—During this process, the heat and pressure fuse the toner into the media to produce a permanent image. The media passes between a heated fusing element and a soft pressure roller, which melt the toner and press it into the media.
7. **Drum-cleaning stage**—During this process, the cleaning blade is in contact with the surface of the drum at all times. As the drum rotates during printing, the cleaning blade wipes excess toner off the drum and stores it in the waste toner receptacle.

## Print cartridge

As the focal point of the image-formation system, the print cartridge contains toner and houses the cleaning, conditioning, and developing stages of the process. The print cartridge contains the photosensitive drum, primary charging roller, developing station, toner cavity, and cleaning station. By including these components (which wear, degrade, or are consumed) in the replaceable print cartridge, the need for many service calls is eliminated. The special photosensitive properties of the drum form an image on the drum surface and then transfer the image to media.

### CAUTION

The print cartridge does not include a light-blocking shutter. Do not expose the drum to light, which can permanently damage the drum. Protect the print cartridge whenever you remove it by covering it with paper.

## Printer paper-feed system

The main input tray and the priority input tray merge into one main input area. The printer uses the top-of-page sensor (PS801) to sense the paper as it enters the paper feed path. It does not sense the presence of media before beginning the print cycle. The following steps occur when the product receives a print job:

Step 1	The ECU activates the motor (M1). Paper motion begins when the ECU energizes the pick-up solenoid (SL1).
Step 2	The paper-pickup roller rotates once. The paper-lift plate pushes the media against the pickup roller.
Step 3	The friction of the pickup roller grabs the top sheet and advances it to the feed-assembly drive rollers. To ensure that only one sheet is fed, a main separation pad holds the remainder of the stack in place.
Step 4	The feed-assembly drive rollers advance the media to the top-of-page sensor (PS801). This sensor informs the ECU of the exact location of the leading edge of media, so that the image being written on the photosensitive drum can be precisely positioned on the page.
Step 5	The feed assembly drive rollers then advance the media to the transfer area where the toner image on the photosensitive drum is transferred to the media.

Step 6	After the image is transferred, the media enters the fuser assembly where heat from the fuser and pressure from the pressure roller permanently bond the toner image to media. The paper-delivery sensor (PS803) determines that the media has successfully moved out of the fusing area.
Step 7	The fuser-assembly exit rollers deliver media to the output bin face-down.

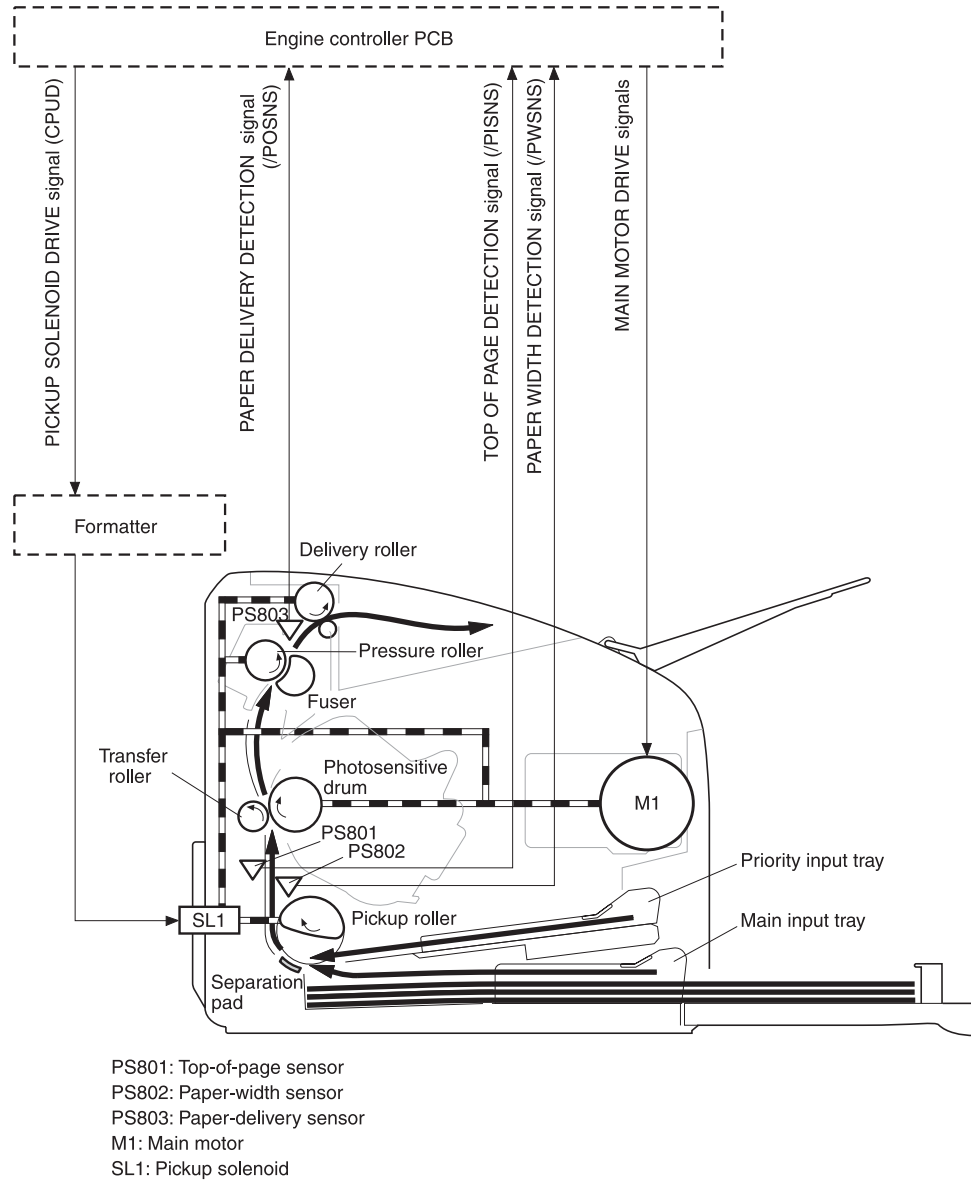


Figure 4-7.

### Printer paper path

### Jam detection in the printer

The top-of-page sensor (PS801) and the paper-delivery sensor (PS803) detect media moving through the printer. If a jam is detected, the ECU immediately stops the printing process and the Attention (Cancel) light illuminates on the control panel.

## Conditions of jam detection

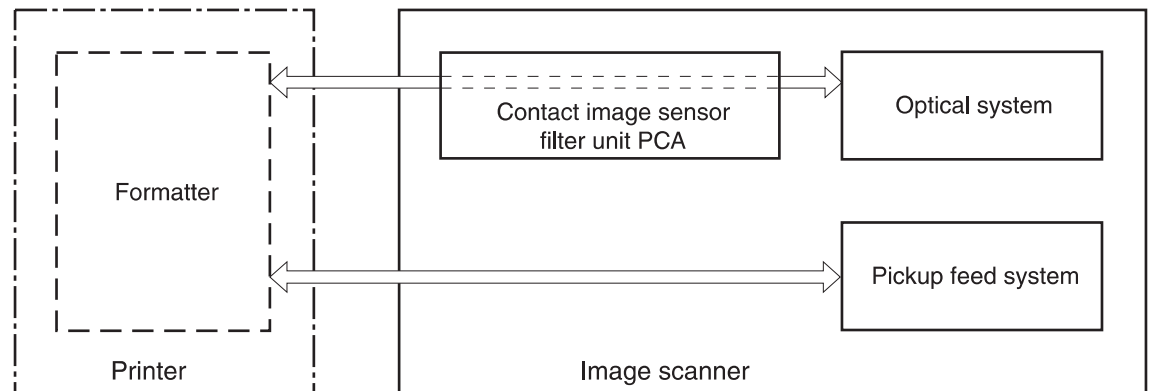
- **Pickup delay jam**—Paper does not reach the top-of-page sensor (PS801) within 1.4 seconds after the pickup solenoid (SL1) has been turned on, a second pickup operation is attempted, and paper again does not reach the top-of-page sensor within 1.4 seconds.
- **Pickup stationary jam**—The top-of-page sensor (PS801) does not detect the trailing edge of media within 4.6 seconds of detecting the leading edge.
- **Delivery-delay jam**—The paper-delivery sensor (PS803) does not detect the leading edge of media within 2.1 seconds after the top-of-page sensor (PS801) detects the leading edge.
- **Wrapping jam**—The paper-delivery sensor (PS803) does not detect the trailing edge of the media within 1.5 seconds after the top-of-page sensor (PS801) detects the leading edge and within ten seconds after the paper-delivery sensor (PS803) detects the leading edge.
- **Delivery-stationary jam**—The paper-delivery sensor (PS803) does not detect the leading edge of media within 2.2 seconds after the top-of-page sensor (PS801) detects the trailing edge.
- **Residual-paper jam**—The top-of-page sensor (PS801) or the paper-delivery sensor (PS803) detects media in the initial rotation period.
- **Door-open jam**—The top-of-page sensor (PS801) or the paper-delivery sensor (PS803) detects media while the print cartridge door is open.

## HP LaserJet 3015 all-in-one unique components

This section presents an overview of the relationships between unique major components in the HP LaserJet 3015 all-in-one. This section describes the optical scanning system and ADF pickup and feed system used in the HP 3015 product. It does not describe the image-formation system that is common to the HP LaserJet 3015/3020/3030 products. For information about image formation, see [Image-formation system](#).

### Basic operation

The HP LaserJet 3015 all-in-one uses a pickup and feed system (document transportation) and an optical scanning system. [Figure 4-8. Basic operation block diagram](#) shows the relationship of the two systems.

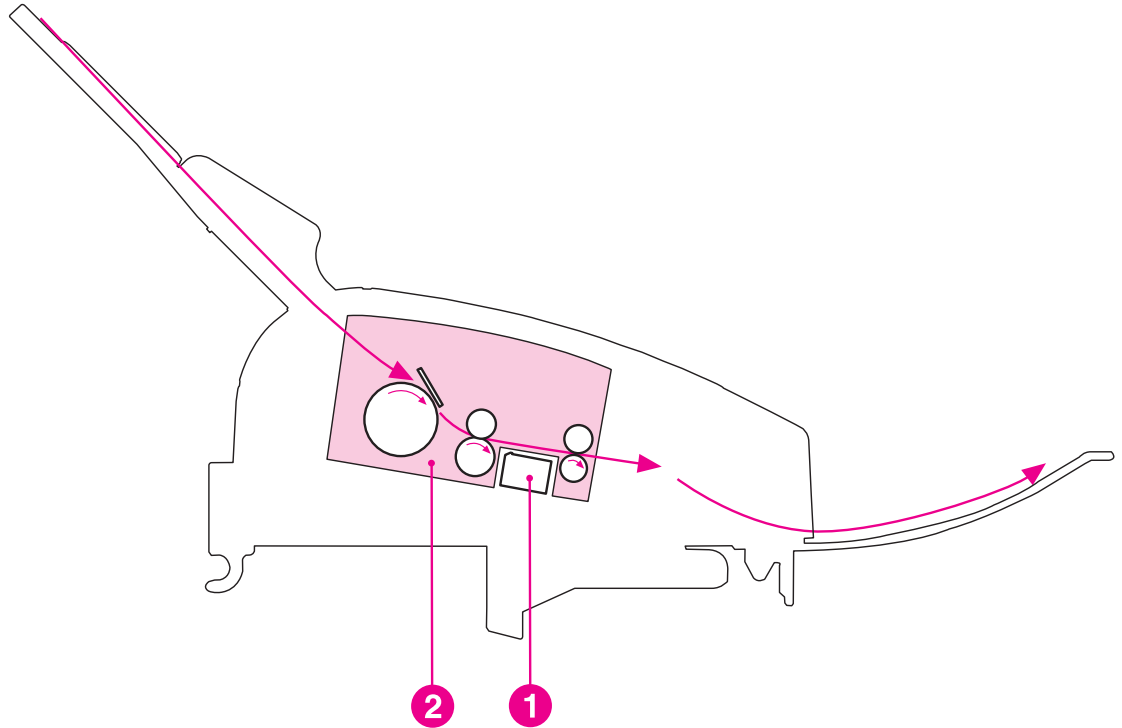


**Figure 4-8.**

#### Basic operation block diagram

A document is placed into the ADF tray. When the formatter sends a signal to the optical scanning system, the document is picked up and fed into the optical system through a series of rollers and a separation pad (the separation pad prevents the pickup system from feeding multiple pages if more than one page is loaded in the ADF tray).

As the document passes the contact image scanner, the scanner illuminates the document. The optical scanning system captures and amplifies the reflected light and converts it to a digital signal, and then sends the digital signal to the formatter for image-processing.



**Figure 4-9.**

#### **HP LaserJet 3015 optical and feed systems**

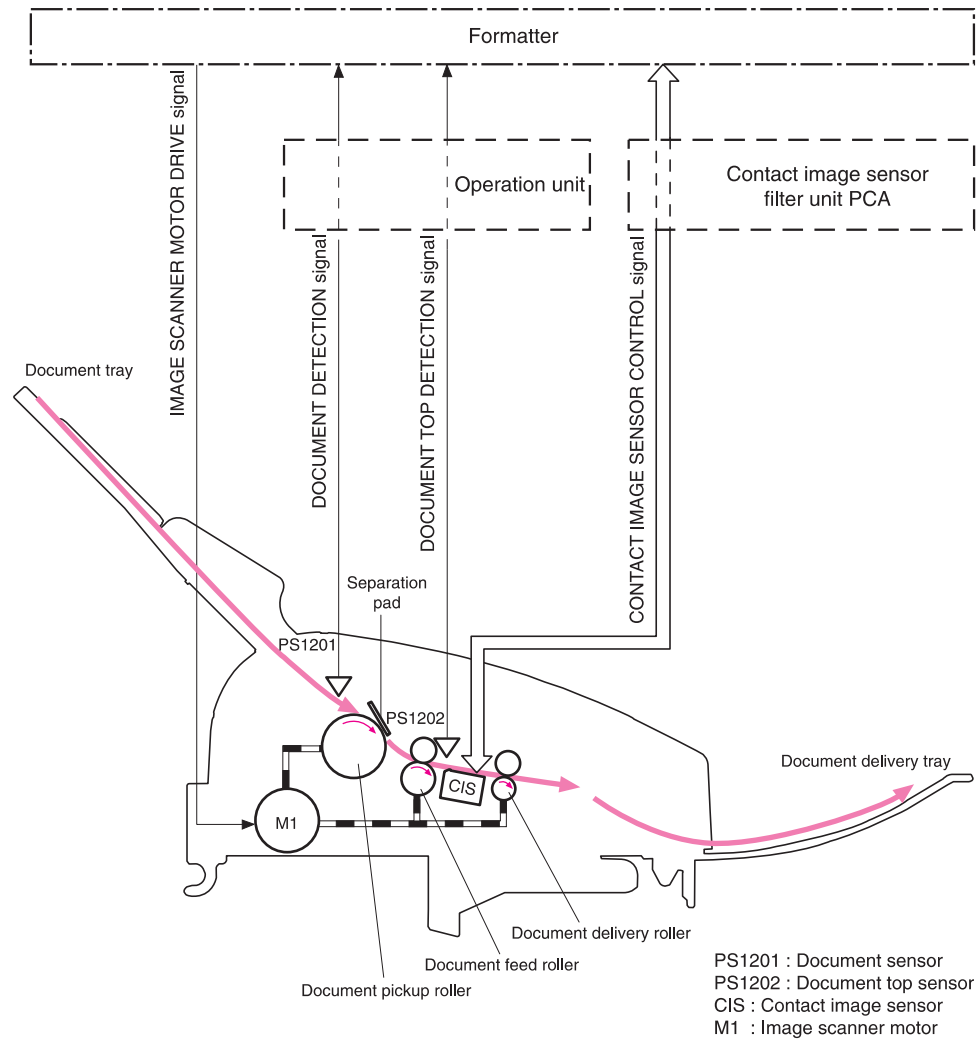
- 1 Optical scanning system
- 2 ADF pickup and feed system

#### **ADF pickup and feed system**

The ADF pickup and feed system uses a pickup roller, a feed roller, and a delivery roller to transport the document into, through, and out of the optical scanning system. The optical scanning system motor drives the rollers when the formatter signals the optical scanning system that a job to print or copy is present.

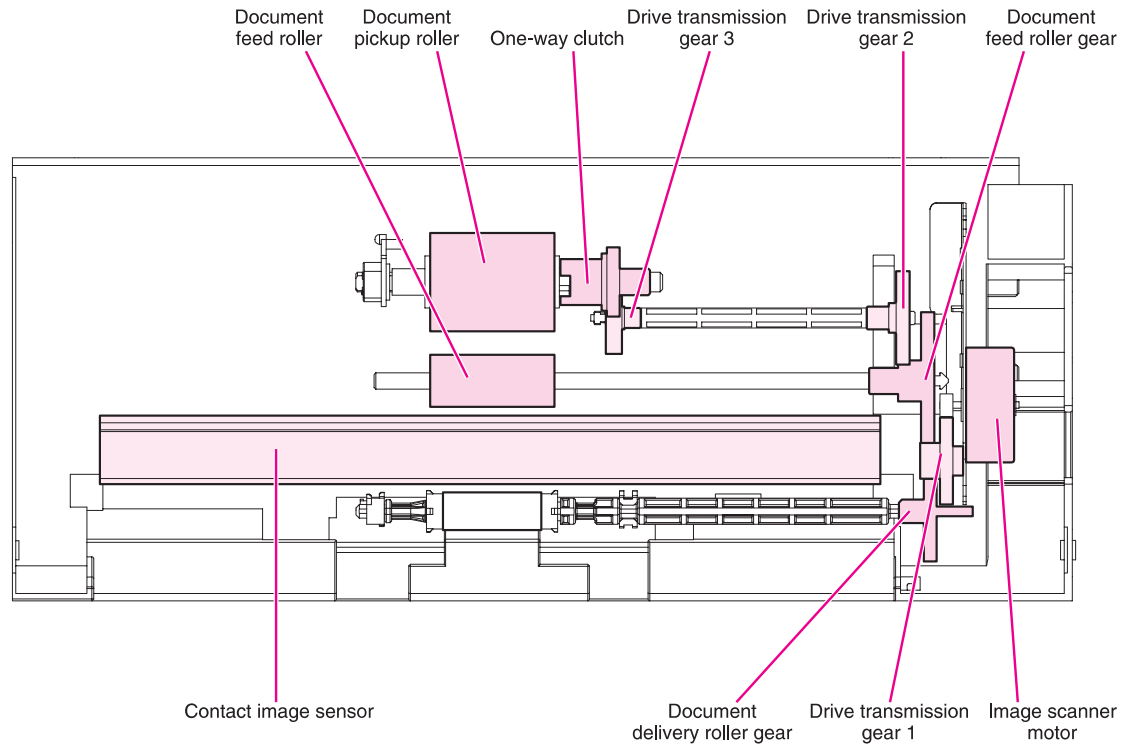
There are two sensors along the ADF pickup and feed paper path. The document sensor (PS1201) detects the presence of a document in the ADF input tray. The document-top sensor (PS 1202) detects the document in the ADF paper path. The formatter processes the signals from the sensors and the product operates accordingly.

When the contact image scanner motor rotates, it causes the pickup, feed, and delivery rollers to rotate. The ADF document pickup roller pushes a document into the ADF paper path. The separation pad prevents multiple pages from entering the ADF paper path by creating friction against the document and the pickup roller. The document feed roller advances the document past the contact image sensor (CIS). The document delivery roller advances the document out of the ADF paper path to the output area.



**Figure 4-10.** HP LaserJet 3015 feed control (1 of 2)

The contact image scanner motor drives the pickup roller, the feed roller, a one-way clutch, and the delivery roller. A gear differential causes the pickup roller to rotate at a slower speed than the feed roller. The slower speed allows for a consistent space between pages of a multiple-page document, which is necessary for correct document scanning. The one-way clutch varies the rotation speeds of the pickup roller and feed roller to prevent the rollers from tearing the document.



**Figure 4-11.** HP LaserJet 3015 feed control (2 of 2)



## Optical scanning system

The contact image sensor (CIS) is the major component of the optical scanning system. The CIS consists of three LEDs (red, green, and blue), a light guide, the scanning glass, the rod lens array, and a sensor array. When the CIS scans a document, the CIS does not move. Instead, documents move past the CIS.

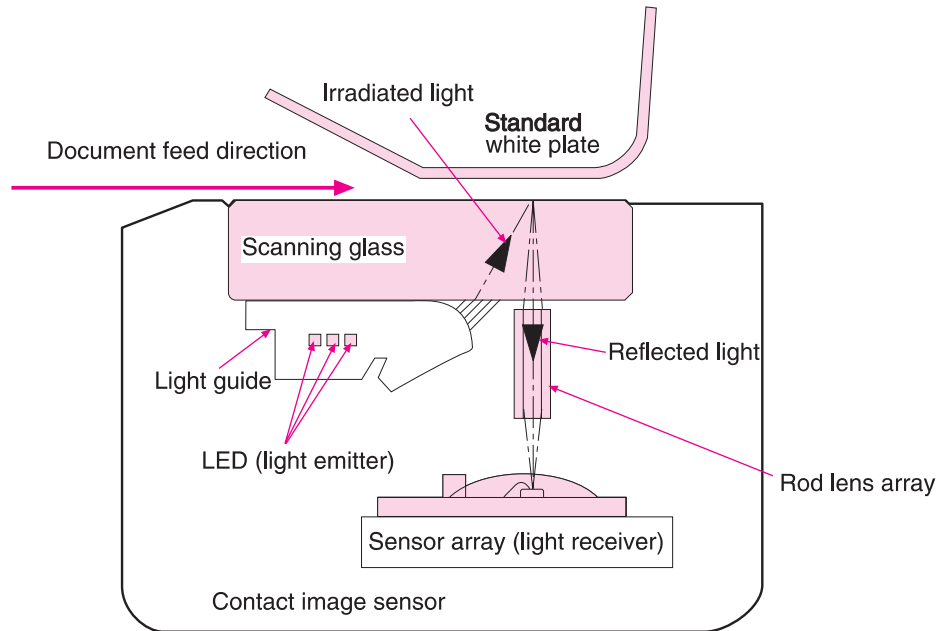
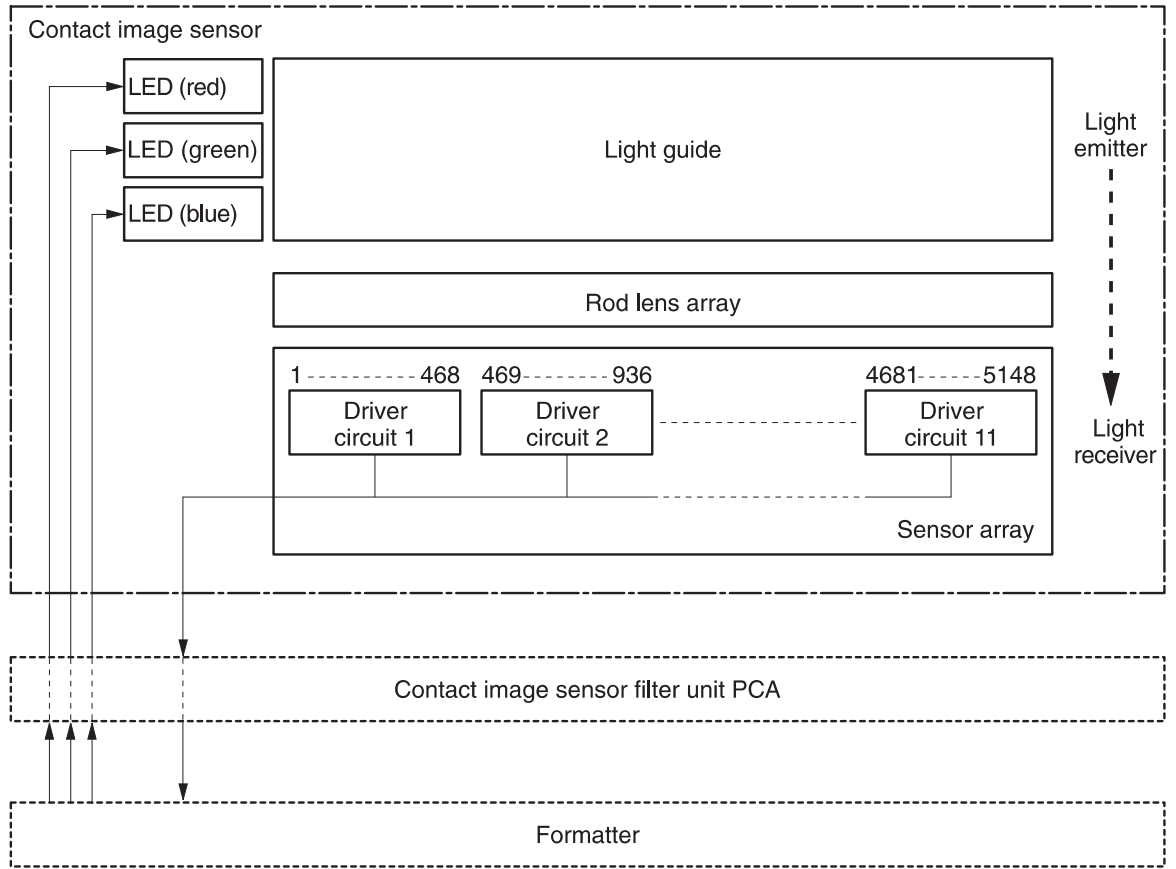


Figure 4-12.

### HP LaserJet 3015 optical system (1 of 2)

The formatter controls the CIS. To begin scanning, the formatter sends a signal to the CIS. The LEDs illuminate and the light passes through the light guide and scanning glass and strikes the document. Light that the document reflects passes back through the scanning glass and rod lens array into the sensor array. The sensor array consists of 5,148 photosensors (468 photosensors on each of 11 sensor driver circuits). The sensor array collects and amplifies the reflected light and converts it into serial data in the driver circuits. The CIS sends the data to the formatter for image formation.



**Figure 4-13.** HP LaserJet 3015 optical system (2 of 2)

## HP LaserJet 3020 and 3030 all-in-one unique components

This section presents an overview of the relationships between unique major components in the HP LaserJet 3020/3030 all-in-one. This section describes the optical scanning system and ADF pickup and feed system used in the HP 3020 and 3030 product. It does not describe the image-formation system that is common to the HP LaserJet 3015, 3020, and 3030 products. For information about image formation, see [Image-formation system](#).

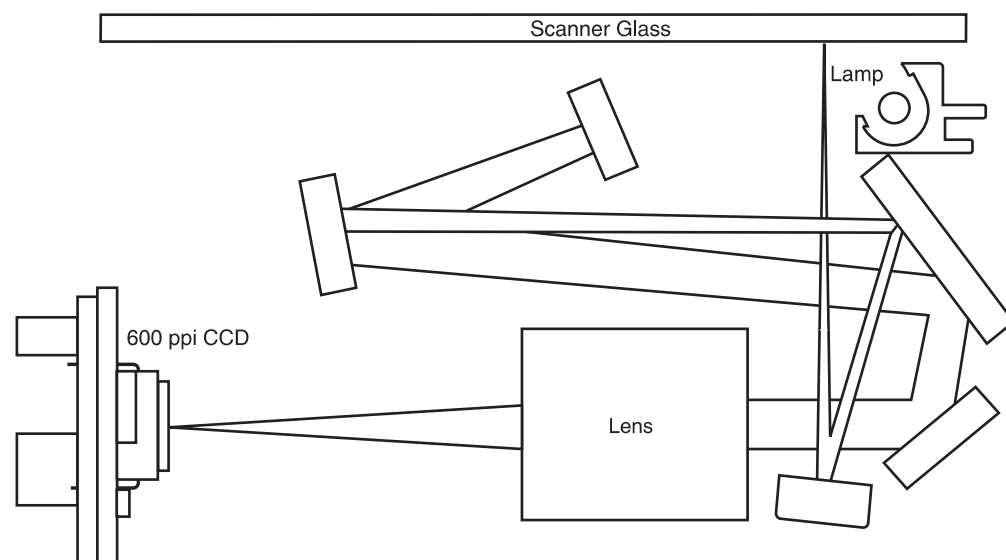
### Scanner and ADF functions and operation

The following sections describe how the document scanner and the automatic document feeder (ADF) function.

#### Scanner functions

The scanner uses a light source, a color-separation method, and a charge-coupled device array (CCD) to collect optical information about the document and transform that into an image file. The scanner consists of these elements:

- a lamp (cold-cathode fluorescent bulb)
- five mirrors and a lens
- a CCD



**Figure 4-14.** HP LaserJet 3020 and 3030 optical system

The scanner lamp illuminates a small strip of the document (called the *raster line*). The mirrors direct the light through the lens to the CCD. The CCD senses and records the light, creating an analog representation of the raster line. If the ADF is being used, the document then advances in the ADF to the next raster line. If the flatbed is being used, the scanner module advances to the next raster line. This advancing and collection process continues to the end of the sheet.

The image data is collected in the motor controller board, where it is processed and sent to the formatter. The formatter then handles the image data, outputting it as a copy, sending it through the LIU as a fax (in the LJ 3030), or directing it to the computer as scanner output.

The image data collected is 600 pixels per inch (ppi). Each pixel has 8 bits for each of the three colors (256 gray scale levels for each color) or a total of 24 bits per pixel (24-bit color).

## Scanner operation

At startup and periodically at other times, the scanner assembly moves systematically to locate its home position. It then calibrates to a white strip located under the glass at the right end of the scan tub.

If the product detects a document in the ADF when a copy or scan is initiated (from the software or the control panel), the scan module moves to the left side of the scan tub and stops. The image is acquired as the paper is fed through the ADF past the scanner module.

If no document is detected in the ADF, or if the model does not have an ADF, the scan module acquires the image from the flatbed glass while slowly moving within the scan tub.

## ADF operation

**Standby (paper-loading) mode:** In standby mode, the pickup roller is up and the stack-stop is down, preventing the user from inserting the original document too far. When a document is inserted correctly, the paper-present sensor detects its presence.

The standard operation of the ADF consists of the pick, feed, and lift steps.

**Pick:** When it receives a copy or scan command, the ADF motor engages the gear train to lower the pickup-roller assembly and raise the stack-stop. The first roller, called the pre-pick roller, moves the top few sheets forward into the ADF. The next roller is the pickup roller. This roller contacts the ADF separation pad, which separates multiple pages into single sheets.

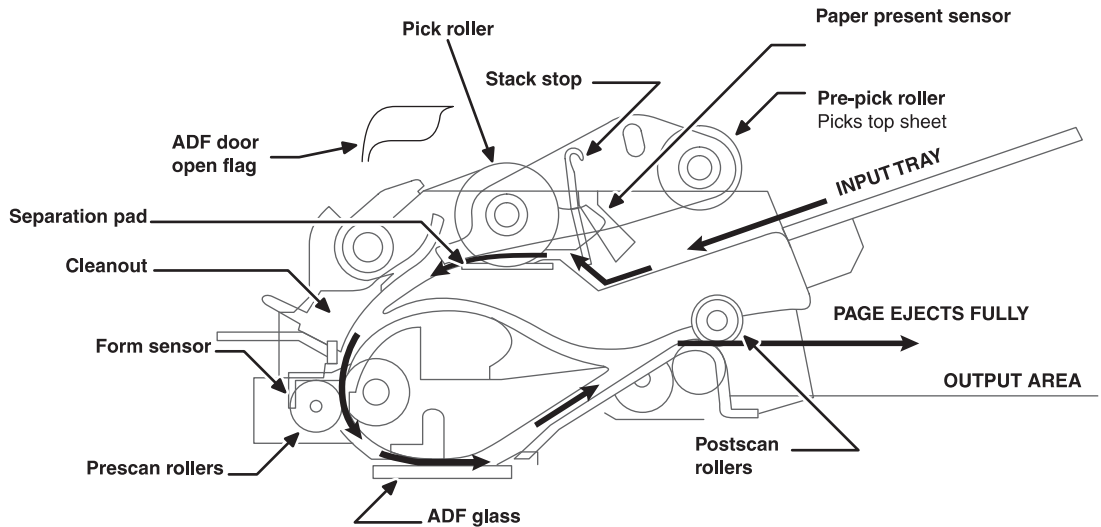
**Feed:** The single sheet continues through the path. Along the way, the form sensor, which is a set distance from the ADF glass, detects the sheet. This alerts the scanner to start when the page reaches the glass. The scanner acquires the image, one raster line at a time, until it detects the end of the page. The page is then ejected. The pick and feed steps are repeated as long as paper is detected in the ADF input tray.

**Lift:** When no more paper is detected in the ADF input tray and the form sensor detects the trailing edge of the last page, the last sheet is ejected and the motor turns in a sequence that lifts the pick roller assembly to standby (paper-loading) mode again.

The ADF will not function when the ADF lid is open. The paper path is incomplete if the ADF lid is lifted from the glass.

## ADF paper path and ADF sensors

The following diagram shows the ADF paper path.



**Figure 4-15.** HP LaserJet 3020 and 3030 ADF path

The paper-present sensor determines if paper is in the ADF. The form sensor detects the top and bottom edges of the document. One other sensor detects an open ADF door.

### ADF jam detection

The ADF has two sensors that detect paper. The paper-present sensor detects the presence of media in the ADF input tray. The form sensor detects media moving through the ADF. If a jam is detected, the ADF immediately stops the paper feeding and a jam message appears on the control-panel display.

A jam can be detected under any of the following conditions:

- **Document-feeder jam**—When documents are detected in the ADF input tray, and a command to copy, scan or fax is received, the scan module travels to the left side of the scan assembly and stops beneath the ADF scanner glass. The ADF then attempts three times, or for about ten seconds, to advance the paper to the form sensor. If the paper does not advance, the scan module travels back to the home position on the right side of the scanner assembly. The message **Document feeder mispick. Reload.** appears on the control-panel display.
- **Long-document jam**—If the paper has advanced to trigger the form sensor, but the trailing edge is not detected within the time allowed for a 381-mm (15-inch) document (the maximum allowable page length for the ADF), the scanner returns to the home position at the right side of the scanner assembly. The message **Doc feeder jam. Clear, Reload.** appears on the control-panel display.
- **Stall jam**—When a page that is less than 381 mm (15 inches) long has advanced to the form sensor but has not left it within the expected time, the paper has probably stalled or jammed. The scanner returns to the home position at the right side of the scanner assembly. The message **Doc feeder jam. Clear, Reload.** appears on the control-panel display.
- **Other**—If the paper stops in the ADF and the scan module remains under the ADF scanner glass, an internal firmware error has probably occurred. This is usually remedied by cycling the power.

# Fax functions and operation (HP LaserJet 3015 and 3030 only)

The following sections describe the fax capabilities of the product.

## PSTN operation

The public switched telephone network (PSTN) operates by having a central office (CO) that generates a constant voltage on the TIP and RING wires (48 V, usually). A device goes on-hook by connecting impedance (such as 600 ohms for the U.S.) across TIP and RING, allowing a line current to flow. The CO can detect this current and can send impulses like dial tones. The product generates more signaling tones, such as dialing digits, to tell the CO how to connect the call. The product can also detect tones, such as a busy tone from the CO, that tell it how to behave.

When the call is finally connected, the CO behaves as if it were a piece of wire connecting the sender and receiver. This is the period during which all of the fax signaling and data transfer occurs. When a call is completed, the circuit opens again and line current flow ceases, removing the CO connection from both the sender and the receiver.

All of this is done with a two-wire arrangement. The two wires are called TIP and RING on all phone systems. On most phone systems, the wires appear on pins 3 and 4 of the RJ-11 modular jack (the one on the LIU). These two wires do not have to be polarized because all the equipment works with either TIP or RING on pin 3 and the other wire on pin 4. This means that cables of either polarity can interconnect and will still work.

These are the basic functions of PSTN operation that are assumed in the design of the fax subsystem. The product generates and detects the signaling tones, currents, and data signals that are required to transmit and receive faxes on the PSTN.

## The fax subsystem

The formatter, LIU, firmware, and software all contribute to the fax functionality. The designs of the formatter and LIU, along with parameters in the firmware, determine the majority of the regulatory requirements for telephony on the product.

The fax subsystem is designed to support V.34 fax transmission, lower speeds (such as V.17 fax), and older fax machines.

## Formatter in the fax subsystem

The formatter contains the modem chipset (DSP and CODEC) that controls the basic fax functions of tone generation and detection, along with channel control for the fax transmissions.

The CODEC and its associated circuitry act to control transmit and receive gains, and to compensate for transmission signal coupling into the receive channel. The formatter also contains circuitry that adds termination impedance to help match the telephone network impedance.

## LIU in the fax subsystem

Two versions of LIU are used in the HP LaserJet 3015 and 3030 all-in-one. One is used in the North American, South American, and Asian countries/regions. The other is used primarily in European countries/regions.

The following are features that are different in the European version:

- a different voltage-protection device
- current limiting of the dc current
- filtering for the countries/regions that use billing or metering tones
- control of the impedance of the dc circuit through the SHUNT signal

Because the TIP and RING are not polarized, all LIU circuitry that connects to TIP and RING is bidirectional. The LIU operates identically when TIP and RING are reversed.

## **Safety isolation**

The most important function of the LIU is the safety isolation between the high-voltage, transient-prone environment of the telephone network (TNV [telephone network voltage]) and the low-voltage analog and digital circuitry of the formatter (SELV [secondary extra-low voltage]). This safety isolation provides both customer safety and product reliability in the telecom environment.

Any signals that cross the isolation barrier do so either optically or magnetically. The breakdown voltage rating of barrier-critical components is greater than 1.5 kV.

## **Safety-protection circuitry**

In addition to the safety barrier, the LIU protects against RING and over-current events.

Telephone over-voltages can be either differential mode or common mode. The RING can be transient in nature (a lightning-induced surge or ESD) or continuous (a power line crossed with a phone line). The LIU protection circuitry provides margin against combinations of RING events.

Common mode protection is provided by the selection of high-voltage-barrier critical components (transformer, relay, and optoisolators). The safety barrier of the LIU PCB traces and the clearance between the LIU and surrounding components also contribute to common mode protection.

A voltage suppressor (a crowbar-type SIDACTOR) provides differential protection. This device becomes low impedance at approximately 300 V differential, and crowbars to a low voltage. A series thermal switch works in conjunction with the crowbar for continuous RING events, such as crossed power lines.

When the differential RING is continuous, the resulting over-current causes the thermal switch to become high impedance, disconnecting RING from the network and protecting the crowbar from thermal overload. The thermal switch automatically resets to low impedance after the over-current condition is removed, reconnecting RING to the network.

## **Data path**

The magnetically coupled signals that cross the isolation barrier go either through a transformer or a relay. The TIP and RING signals use a transformer to cross the isolation barrier.

TIP and RING are the two-wire paths for all signals from the telephone network. All signaling and data information comes across them, including fax tones and fax data.

The telephone network uses dc current to determine the hook state of the telephone, so line current must be present during a call. On some line interfaces this current flows through the transformer, but on the LIU, a capacitor blocks the current from going into the transformer.

Blocking the current with a capacitor prevents the core of the transformer from being saturated by the high dc voltage, which can affect the ac signal quality. Rather than permitting the current to flow through the transformer, this LIU directs the current through another circuit called a gyrator or dc hold circuit. This creates the path for the central office-current flow when a call is in progress.

## Hook state

Another magnetically coupled signal is the control signal that disconnects the downstream telephone devices (such as a phone or answering machine). A control signal originating on the formatter can change the relay state, causing the auxiliary jack (downstream jack) to be disconnected from the circuit.

The product takes control of calls that it recognizes as fax calls. If the product does not directly pick up the call, it monitors incoming calls for the fax tone or for the user to direct it to receive a fax. This idle mode is also called eavesdropping. This mode is active when the product is on-hook but current exists in the downstream phone line because another device is off-hook. During eavesdropping, the receive circuit is enabled but has a different gain from the current that is generated during normal fax transmissions.

The product does not take control of the line unless it detects a fax tone or the operator tells it to connect manually. This feature allows the user to make voice calls from a phone that is connected to the product without being cut off if a fax is received.

## Downstream current detection

The aux phone detect signal is optically coupled. This signal tells the firmware that an active phone (or modem or answering machine) is connected to the auxiliary port of the product (the right side of the RJ-11 jack).

A circuit that can detect current above a certain threshold generates the downstream-current-detection signal. The downstream current goes through a resistor, generating a voltage. If this voltage is above the threshold level, the signal changes state.

The downstream-current-detection signal is coupled back to the formatter through an optoisolator and across the safety isolation barrier. The firmware uses this signal to ensure that the product does not go off-hook (and disconnect a downstream call) until it has been authorized to do so (by a manual fax start or detection of the appropriate tones).

## Hook switch control

Another optically coupled signal is the hook switch control. This signal from the formatter causes an optoisolator on the LIU to activate (making an open circuit into a short circuit). When shorted, the circuit is drawing dc current from the central office and is considered “on-hook.” When open, no dc current flows and the state is considered to be “off-hook.”

For pulse dialing, the optoisolator is toggled on and off with a particular timing sequence to generate pulses that the central offices of the telephone company recognizes as dialing digits.

## Ring detect

Another optically coupled signal on the LIU is ring detect. Ring detect is a combination of voltage levels and cadence (time on and time off). Both must be present in order for the product to detect a valid ring.

The LIU works with the firmware to determine if an incoming signal is an answerable ring. When circuits on the LIU detect a ring voltage above a certain threshold, a corresponding signal is passed to the formatter to indicate that the ring is above the threshold. The firmware then measures the amount of time that the signal is high and low, and qualifies the cadence to determine whether it is a valid ring.



## Line current control

The dc current from the CO needs to have a path to flow from TIP to RING. Because the current does not flow in the transformer, a path through some transistors and diodes (the dc hold circuit) acts like a simulated inductor (thus replacing the function of the transformer). This dc hold circuit is the main component of the voltage-current characteristic between TIP and RING.

Two other functions of this block of circuits are the current limit and the SHUNT for Europe. Current limit basically maintains a constant current from TIP to RING after the voltage reaches about 50 mA. Even if the voltage varies, the current will remain the same.

The SHUNT function changes the impedance (the current-voltage characteristic) during certain special events, such as pulse dialing and when the device goes on-hook.

During such an event, the firmware tells the DSP on the formatter to activate SHUNT. A signal goes to the LIU through an optoisolator (optically coupled), which changes the state of some transistors so that the board has a linear current characteristic (normally, it is current-limited). Then more current can flow to the network, as required by these special events.

## Billing (metering) tone filters

Switzerland and Germany provide high-frequency ac signals on the phone line in order to bill customers. The LC (inductor, capacitor) notch filters are provided on the European LIUs to prevent these billing signals from adversely affecting the data path and the dc hold circuit.

An additional filter in the cable (for certain countries/regions) can, in some cases, supplement these LC notch filters. Because these billing signals are not used in the U.S., these filters are not present on the U.S. LIU.

## Fax page storage in flash memory

Fax pages are the electronic images of the document page. They can be created in any of three ways: scanned to be sent to another fax machine, generated to be sent by the computer, or received from a fax machine to be printed.

The product stores all fax pages in flash memory automatically. After these pages are written into flash memory they are stored until the pages are sent to another fax machine, printed on the product, transmitted to the computer, or erased by the user.

These pages are stored in flash memory, which is the nonvolatile memory that can be repeatedly read from, written to, and erased. The product has 4 MB of flash memory, of which 3.4 MB is available for fax storage. The remaining 0.6 MB is used for the file system and reclamation. Adding RAM does not affect the fax page storage because the product does not use RAM for storing fax pages.

## Stored fax pages

The user can reprint stored fax pages in case of errors. The product will re-send stored fax pages after a busy signal, comm error, no answer, or a power failure. Other fax devices store fax pages in either normal RAM or short-term RAM. Normal RAM immediately loses its data when power is lost, while short-term RAM loses its data about 60 minutes after a power failure. Flash memory maintains its data for years without any applied power.

## Advantages of flash memory storage

Fax pages stored in flash memory are persistent. They are not lost as a result of a power failure, no matter how long the power is off. Users can reprint faxes in case the print cartridge runs out of toner or the product experiences other errors while printing faxes.

The product also has scan-ahead functionality that makes use of flash memory. Scan-ahead automatically scans pages into flash memory before a fax job is sent. This allows the sender to pick up their original document immediately after it is scanned, eliminating the need to wait until the fax is transmission is complete.

Because fax pages are stored in flash memory, not RAM, more RAM is available to handle larger and more complicated copy and print jobs.

# 5

## Removal and replacement

This chapter provides information about the following topics.

Removal and replacement strategy.....	103
Required tools.....	103
Before performing service.....	103
After performing service.....	104
Parts removal order.....	104
HP LaserJet 3015 all-in-one.....	107
Link assemblies and scanner support frame springs.....	107
Scanner side covers.....	110
Separation-pad set.....	111
Control-panel bezel.....	112
Control-panel assembly.....	113
Media lever and media lever torsion spring.....	114
Separation pad assembly.....	115
Scanner assembly.....	118
Scanner assembly top cover.....	126
Top-cover assembly.....	129
Pickup roller .....	130
White platen.....	131
HP LaserJet 3020 and 3030 all-in-one.....	133
ADF input tray.....	133
Flatbed lid.....	134
Link assemblies and scanner support frame springs.....	136
Control-panel bezel.....	139
Control-panel assembly.....	139
ADF separation pad .....	140
ADF input-tray flag.....	141
ADF pickup roller .....	142
ADF scanner glass.....	143
Scanner assembly.....	145
Printer (product base).....	153
Printer separation pad.....	154
Print cartridge.....	154
Printer pickup roller.....	156
Media input tray.....	158
Transfer roller.....	159
Printer side covers.....	161
Print-cartridge door.....	163
Rear cover and fuser cover.....	164
Front cover.....	165
Installing the scanner cushions.....	167
Speaker assembly.....	168
Power supply.....	169
Formatter and line interface unit (LIU).....	171
Scanner support frame .....	175
Engine controller unit.....	177

Laser/scanner assembly.....	181
Main motor.....	182
Fuser.....	184
Paper-pickup assembly.....	186

## Removal and replacement strategy

This chapter documents the removal and replacement of field replaceable parts (FRUs) only. Reinstallation is generally the reverse of removal. Occasionally, notes and hints are included to provide directions for difficult or critical replacement procedures.

---

### WARNING!

Unplug the power cord from the power outlet (at the wall receptacle) before attempting to service the product. If this warning is not followed, severe injury can result. Certain functional checks during troubleshooting must be performed with power supplied to the product. However, the power supply should be disconnected during removal.

Sheet-metal and plastic edges in the product can be sharp. Use caution when servicing this product.

Never operate or service the product with the protective cover removed from the laser/scanner assembly. The invisible reflected beam can damage your eyes.

---

### CAUTION

The product contains components that are sensitive to electrostatic discharge (ESD). Always perform service work on an ESD-protected workstation. If an ESD-protected workstation is not available, discharge body static by grasping the print engine chassis before touching an ESD-sensitive component. Ground the print engine chassis *before* servicing the product.

---

### CAUTION

Do not bend or fold the FFCs during the removal or reinstallation process.

---

### Note

For service purposes, the upper part of the HP LaserJet 3015, 3020, and 3030 is, in effect, the "scanner" and the lower part is the "printer". Together, they also act as a photocopier or fax machine (the HP LaserJet 3020 does not have fax capabilities), but the service description here is simplified by referring to copier or fax functionality only when specifically necessary.

---

### Hint

To install a self-tapping screw, first turn it counterclockwise to align it with the existing thread pattern, then carefully turn it clockwise to tighten. Do not overtighten.

## Required tools

- #2 Phillips screwdriver with magnetic tip
- Small flat-blade screwdriver
- #8 and #10 torx screwdrivers
- Needle-nose pliers
- ESD mat (if available)
- Penlight (optional)
- Long flat-blade screwdriver (optional)

---

### CAUTION

Do not use a pozidrive screwdriver or any motorized screwdriver. These can damage screws or screw threads on the product.

## Before performing service

- If possible, print a configuration page (to record customer settings) and menu structure report. See [Troubleshooting tools](#).
- Remove all media from the product and remove the main input tray. See [Printer main input tray \(all models\)](#).
- Turn off the power by using the power switch.

- Unplug the power cord from the wall receptacle.
- Place the product on an ESD mat, if available. If an ESD-protected workstation is not available, discharge body static and ground the print engine chassis *before* servicing the product.
- Remove the print cartridge. See [Print cartridge](#).

## After performing service

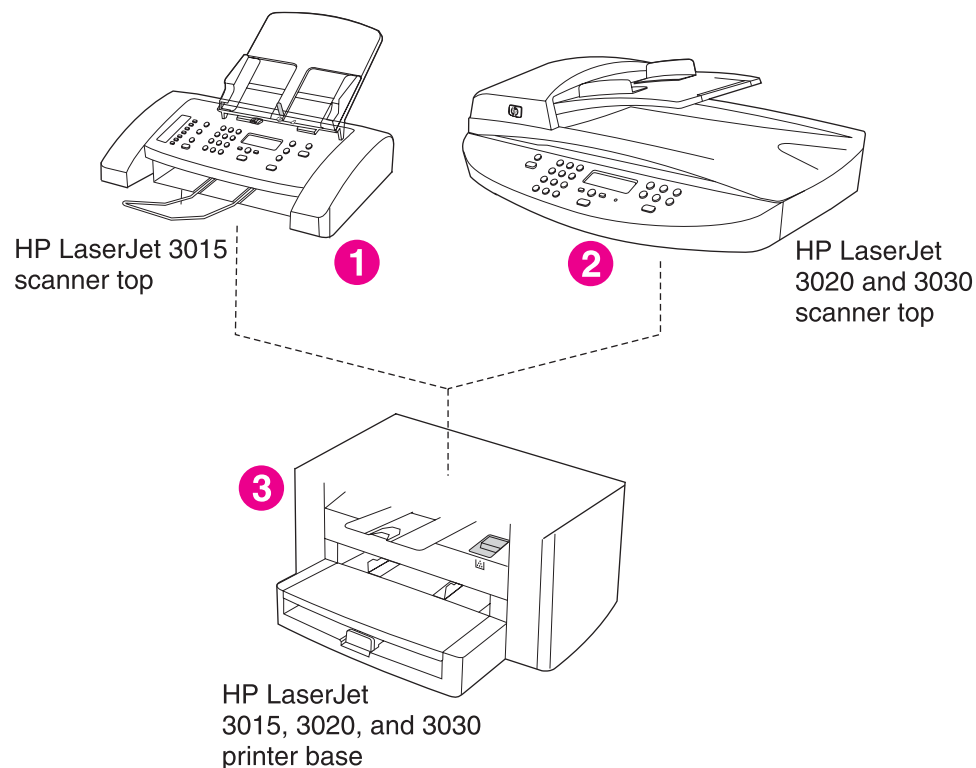
- Replace the print cartridge.
- Reload the input tray with media.
- Restore customer configuration settings.

## Parts removal order

Use the following diagrams to determine which parts of the product must be removed before servicing.

### Note

**HP LaserJet 3020 and 3030:** The scanner assembly might be contaminated if it is opened outside of a cleanroom environment. For this reason, the entire scanner assembly is replaceable only as a unit. Replacing the scanner assembly as an entire assembly replaces the CIS or CCD scan module, the CCD scan motor, and the cable. If the ADF fails, it too is replaceable only as an entire assembly. Replacing the ADF replaces the ADF cable and other ADF submechanisms.



**Figure 5-1.**

### HP LaserJet 3015, 3020, and 3030 products

- 1 Product number Q2669A (HP LaserJet 3015)
- 2 Product number Q2665A (HP LaserJet 3020); Q2666A (HP LaserJet 3030)
- 3 The printer (product base) does not have a product number, but is similar to product number Q2460A (HP LaserJet 1010)

- Scanner side covers
- Separation pad set (not the entire assembly)
- Link assemblies and scanner support frame springs
- HP LaserJet 3015 scanner assembly
  - Scanner assembly top cover
    - Top cover assembly
      - Pickup roller
      - White platen
- Control-panel bezel
  - Control-panel assembly
  - Media lever and torsion spring
  - Separation pad assembly

**Figure 5-2. Parts removal order for the HP LaserJet 3015 all-in-one**

**Note**

The *separation pad set* and the *separation pad assembly* are two different assemblies.

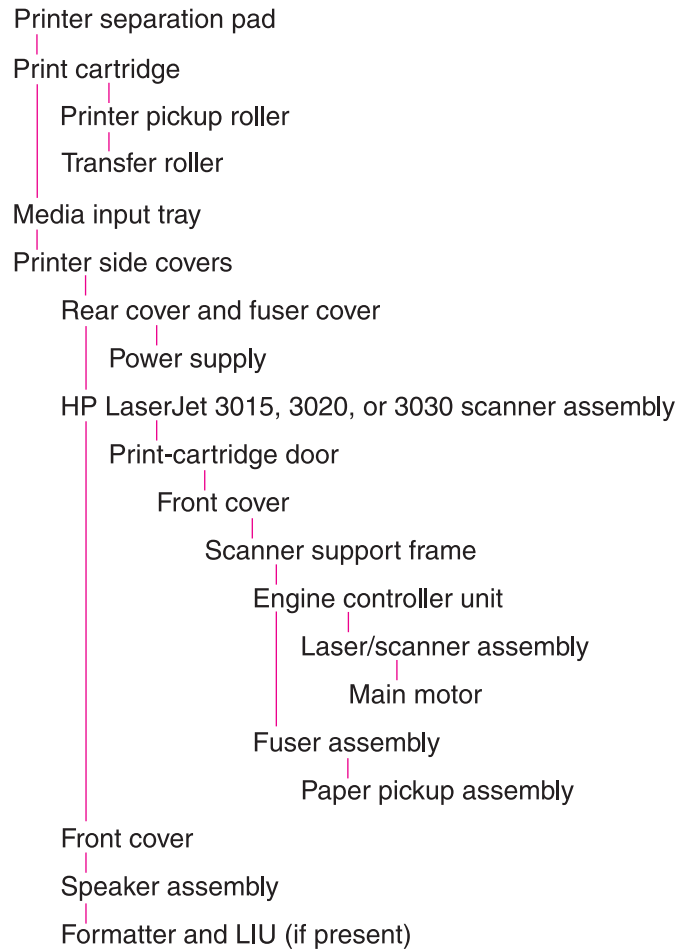
The separation pad set consists of the pad, clear plastic sheet, and the pad cover. The separation pad set *is* a user replaceable assembly.

The separation pad assembly consists of the separation lever, tension spring, feed arm, and the components of the separation pad set. The separation pad assembly *is not* a user replaceable assembly.

Only trained service personnel should attempt to replace the separation pad assembly.

- ADF input tray
  - Flatbed lid
    - HP LaserJet 3020 and 3030 scanner assembly
- Link assemblies and scanner support frame springs
- Control-panel bezel
  - Control-panel assembly
- Separation pad assembly
- ADF input-tray flag
- Pickup roller assembly
- ADF glass

**Figure 5-3. Parts removal order for the HP LaserJet 3020 and 3030 all-in-one**



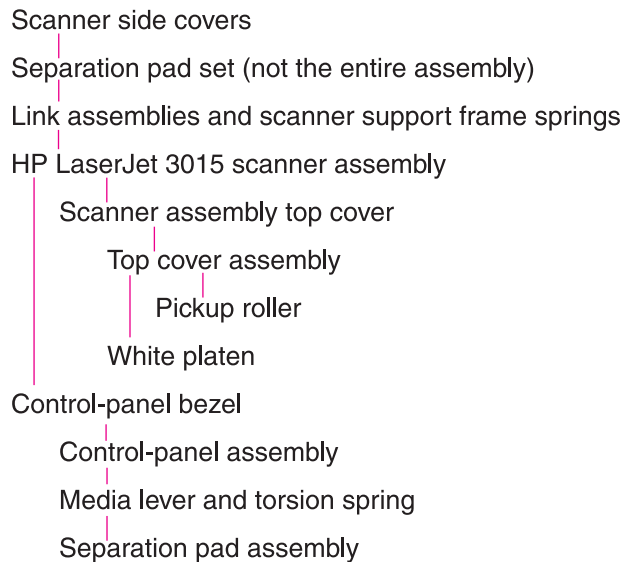
Note: the front cover is listed twice.

**Figure 5-4.** Parts removal order for the printer (product base, all models)



# HP LaserJet 3015 all-in-one

This section documents removal and replacement instructions for components that are unique to the HP LaserJet 3015 product.



**Figure 5-5. Parts removal order HP LaserJet 3015 scanner assembly**

## Note

The *separation pad set* and the *separation pad assembly* are two different assemblies.

The separation pad set consists of the pad, clear plastic sheet, and the pad cover. The separation pad set *is* a user replaceable assembly.

The separation pad assembly consists of the separation lever, tension spring, feed arm, and the components of the separation pad set. The separation pad assembly *is not* a user replaceable assembly.

Only trained service personnel should attempt to replace the separation pad assembly.

## Link assemblies and scanner support frame springs

1. Push the print-cartridge access button and raise the the scanner assembly until it is locked open.

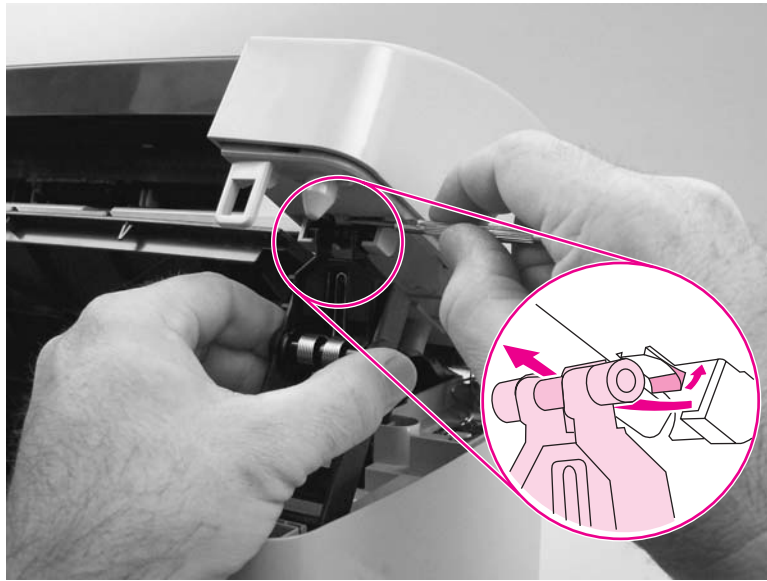
2. Use a small flat-blade screwdriver to release the link tabs on each link assembly.

**WARNING!**

When the link assemblies are disengaged, the scanner assembly can easily fall off of the product base if it is rotated too far towards the back of the product.

**CAUTION**

Do not push too hard on the link tabs or the tab might break.



**Figure 5-6.**

**Remove the link assemblies and scanner support frame springs (1 of 4)**

3. Rotate a link assembly toward the front of the printer until the link disengages from the scanner support frame.



**Figure 5-7.**

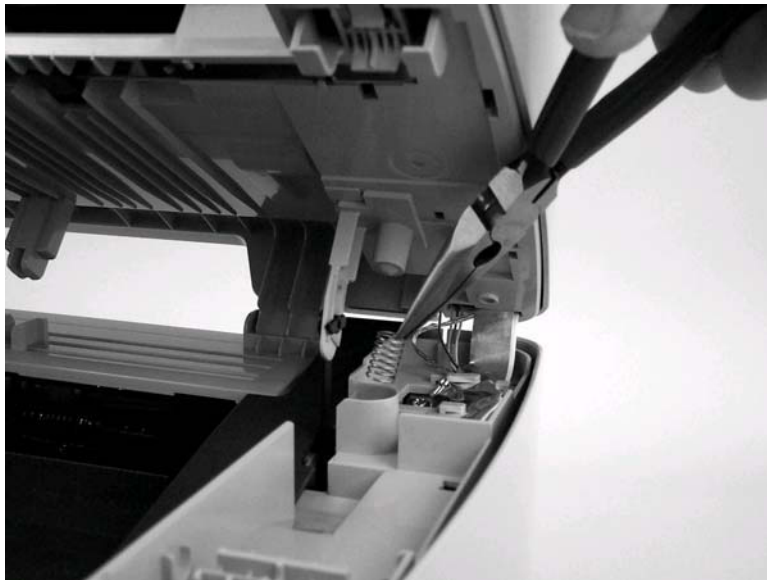
**Remove the link assemblies and scanner support frame springs (2 of 4)**

4. Remove the link assembly. Repeat this step with the remaining link.



**Figure 5-8.** Remove the link assemblies and scanner support frame springs (3 of 4)

5. Use needle-nose pliers to remove the scanner support frame spring. Repeat this step for the other scanner support frame spring.



**Figure 5-9.** Remove the link assemblies and scanner support frame springs (4 of 4)

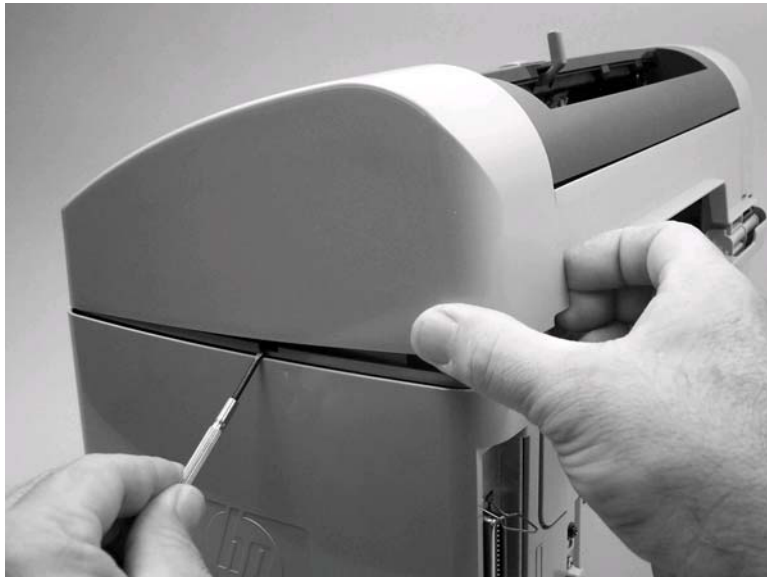
## Scanner side covers

1. Use a small flat-blade screwdriver to release the right-side cover back tab.



**Figure 5-10.** Remove the scanner side covers (1 of 3)

2. Release the right-side cover center tab.



**Figure 5-11.** Remove the scanner side covers (2 of 3)

3. Rotate the right-side cover toward the front of the product, and remove it. Repeat this procedure for the left-side cover.



**Figure 5-12.** Remove the scanner side covers (3 of 3)

## Separation-pad set

---

### Note

The *separation pad set* and the *separation pad assembly* are two different assemblies.

The separation pad set consists of the pad, clear plastic sheet, and the pad cover. The separation pad set *is* a user replaceable assembly.

The separation pad assembly consists of the separation lever, tension spring, feed arm, and the components of the separation pad set. The separation pad assembly *is not* a user replaceable assembly.

---

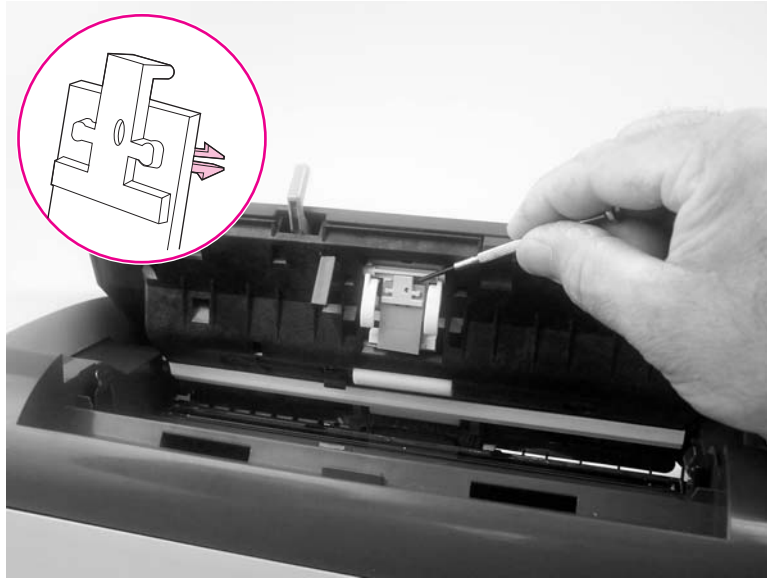
Only trained service personnel should attempt to replace the separation pad assembly.

1. Open the scanner top cover.

2. Carefully pry the separation-pad set away from the guide assembly.

**CAUTION**

When installing the replacement pad, be careful not to bend or break the retainer-clip pins.



**Figure 5-13.** Remove the separation pad

### Control-panel bezel

1. Carefully release the three front locking tabs (callout 1).

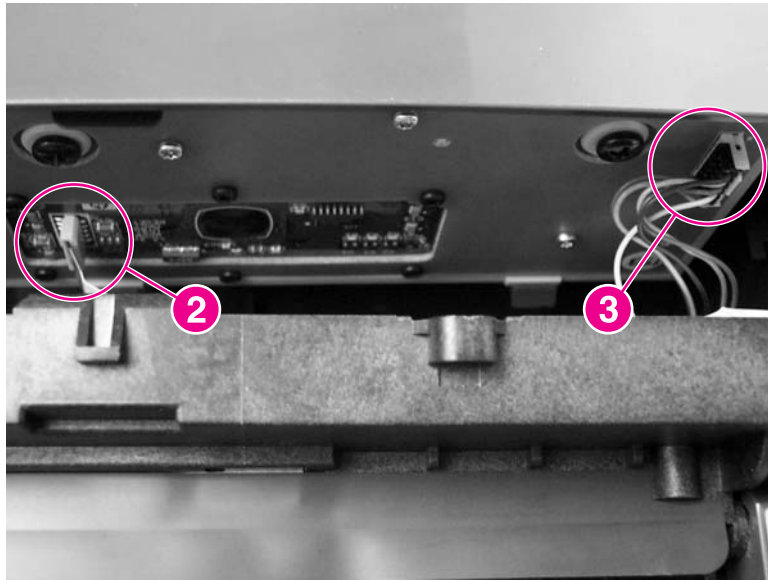


**Figure 5-14.** Remove the control-panel bezel (1 of 3)

2. Slightly raise the control-panel bezel. Then disconnect one FFC (callout 2) and one wire-harness connector (callout 3).

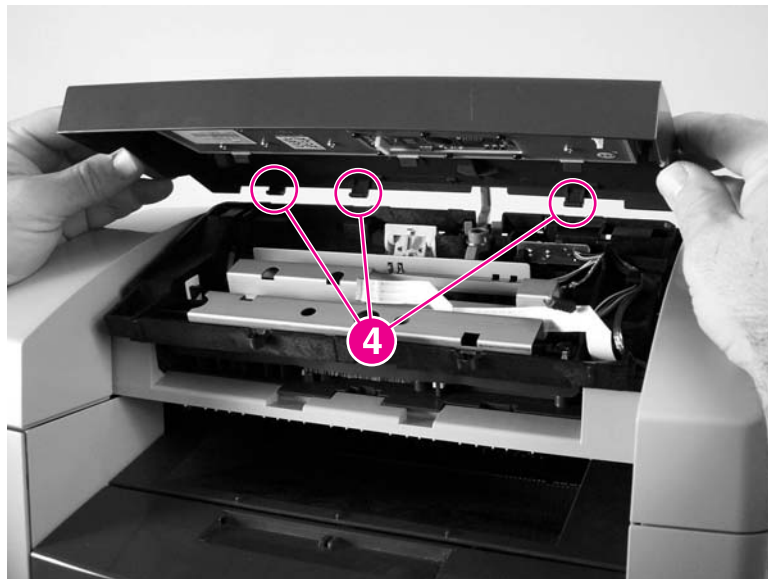
**CAUTION**

Do not bend or fold the FFCs during the removal or reinstallation process.



**Figure 5-15.** Remove the control-panel bezel (2 of 3)

3. Push the control-panel bezel toward the back of the product to release the rear locking tabs (callout 4) and then remove it.



**Figure 5-16.** Remove the control-panel bezel (3 of 3)

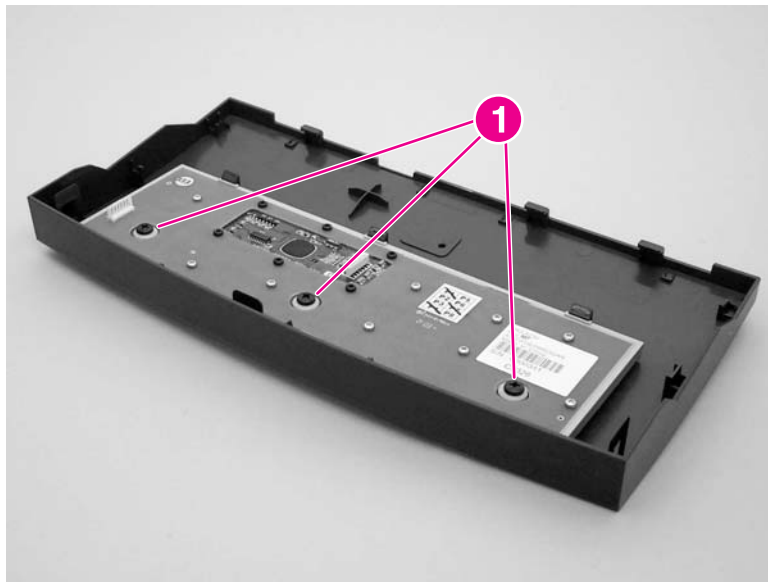
## Control-panel assembly

**CAUTION**

The control panel is an ESD-sensitive component.

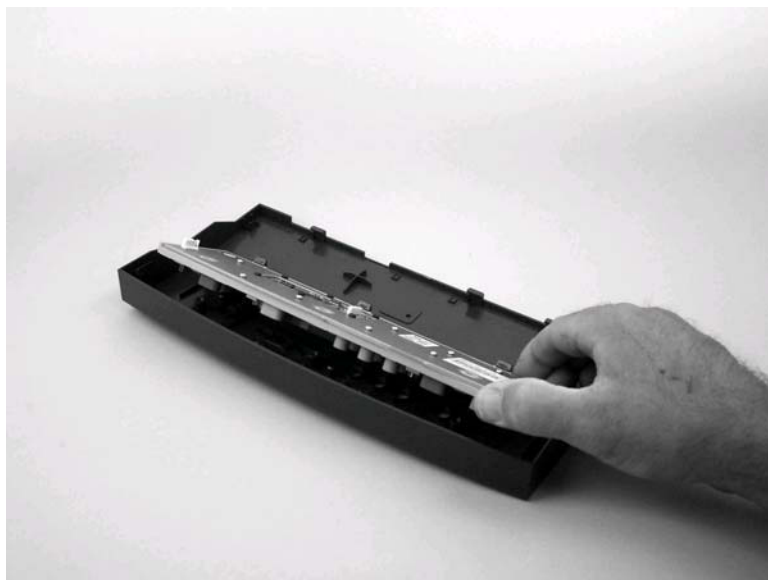
1. Remove the control-panel bezel. See [Control-panel bezel](#).

2. Remove three screws (callout 1).



**Figure 5-17.** Remove the control-panel assembly (1 of 2)

3. Rotate the control-panel button assembly away from the control-panel cover and remove it.



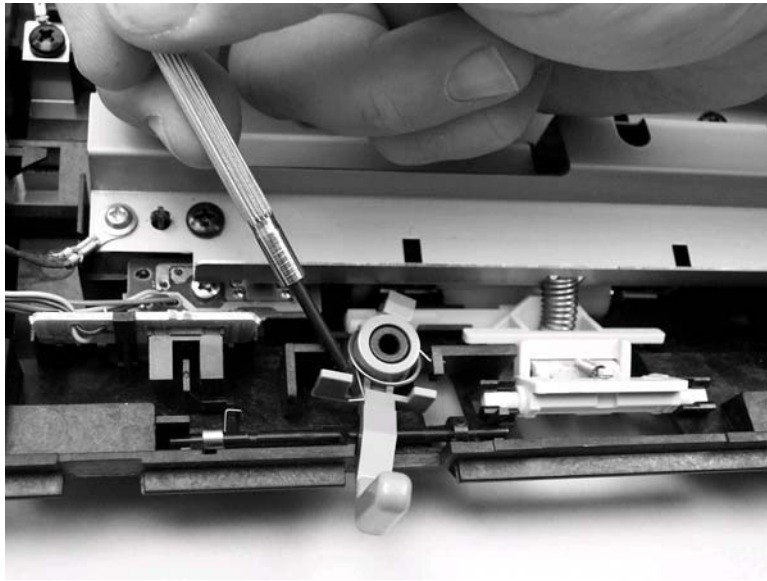
**Figure 5-18.** Remove the control-panel assembly (2 of 2)

## Media lever and media lever torsion spring

1. Remove the control-panel bezel. See [Control-panel bezel](#).

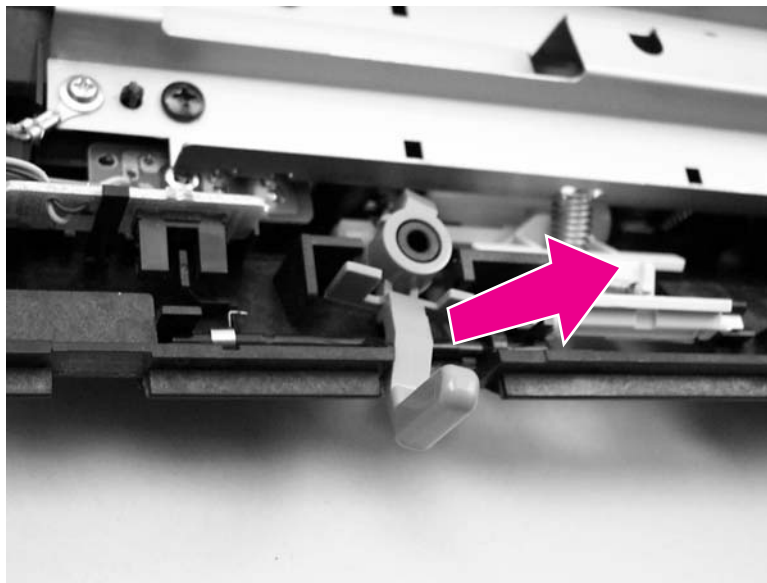


2. Carefully dislodge and remove the media lever torsion spring.



**Figure 5-19.** Remove the media lever and media lever torsion spring (1 of 2)

3. Lift the media lever up and out of the guide assembly to remove it.



**Figure 5-20.** Remove the media lever and media lever torsion spring (2 of 2)

## Separation pad assembly

1. Remove the control-panel bezel. See [Control-panel bezel](#).

2. Remove four screws (callout 1) and the sheet-metal plate.

---

**CAUTION**

Do not touch the grey separation pad. Skin oils and fingerprints on the separation pad might cause paper-feed problems.

Press down on the plate as the screws are removed. There are four compression springs under the plate. The separation pad assembly also has one compression spring attached to the shield. Do not loose any springs when the shield is removed.

---

**Note**

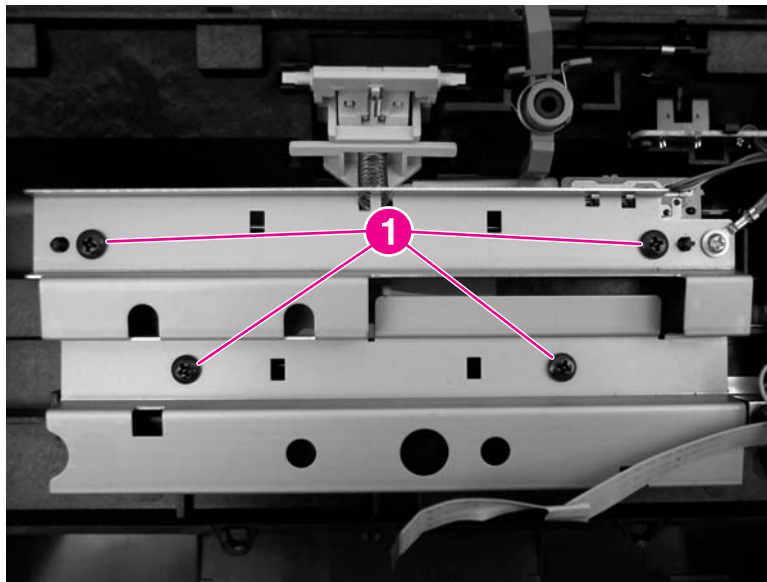
The *separation pad set* and the *separation pad assembly* are two different assemblies.

The separation pad set consists of the pad, clear plastic sheet, and the pad cover. The separation pad set *is* a user replaceable assembly.

The separation pad assembly consists of the separation lever, tension spring, feed arm, and the components of the separation pad set. The separation pad assembly *is not* a user replaceable assembly.

---

Only trained service personnel should attempt to replace the separation pad assembly.



**Figure 5-21.**

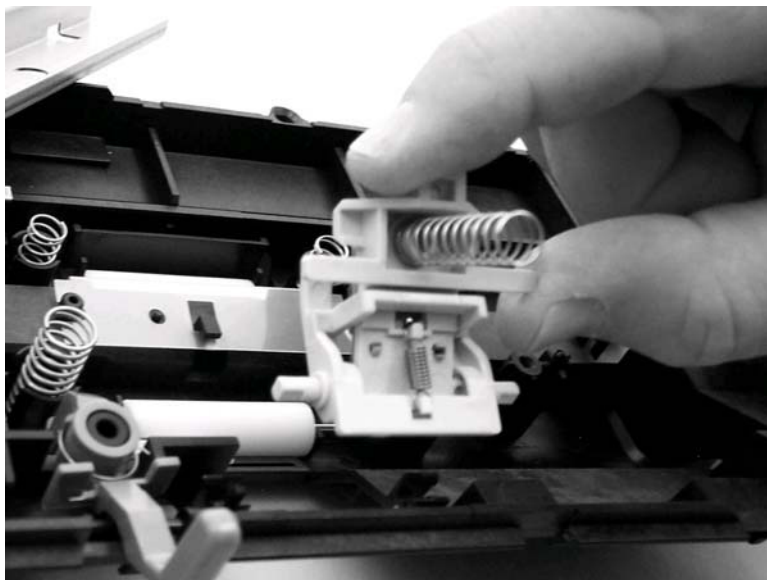
**Remove the separation pad assembly (1 of 3)**

3. Rotate the separation pad assembly up until the keyed hinges can clear the hinge retainers. .



**Figure 5-22.** Remove the separation pad assembly (2 of 3)

4. Remove the separation pad assembly.



**Figure 5-23.** Remove the separation pad assembly (3 of 3)

### **Reinstallation tip**

Make sure that the separation pad assembly compression spring is installed correctly and that the assembly can move freely.

## Scanner assembly

1. Rotate the automatic document feeder ( ADF ) input tray assembly toward the front of the product, and then lift it up and off of the product.



**Figure 5-24.**

### Remove the scanner assembly (1 of 15)

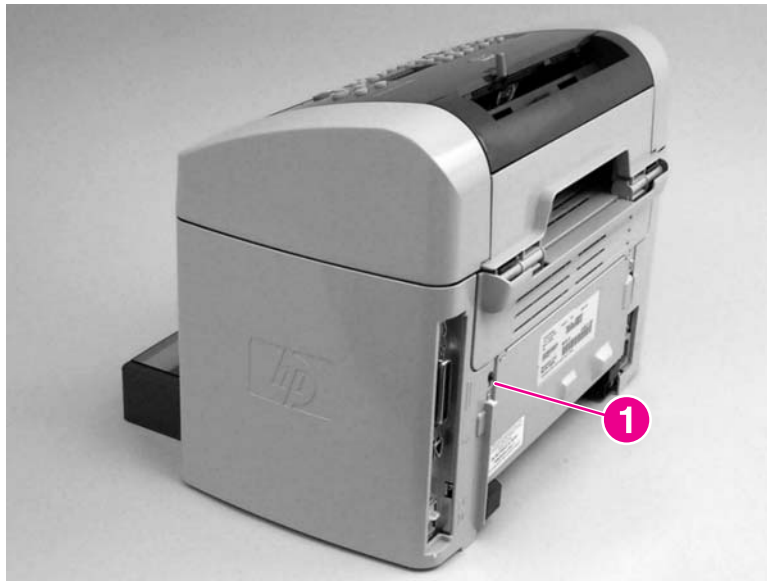
2. Squeeze the wire ADF output bin until the the ends of the wire clear the mounting holes in the scanner assembly.



**Figure 5-25.**

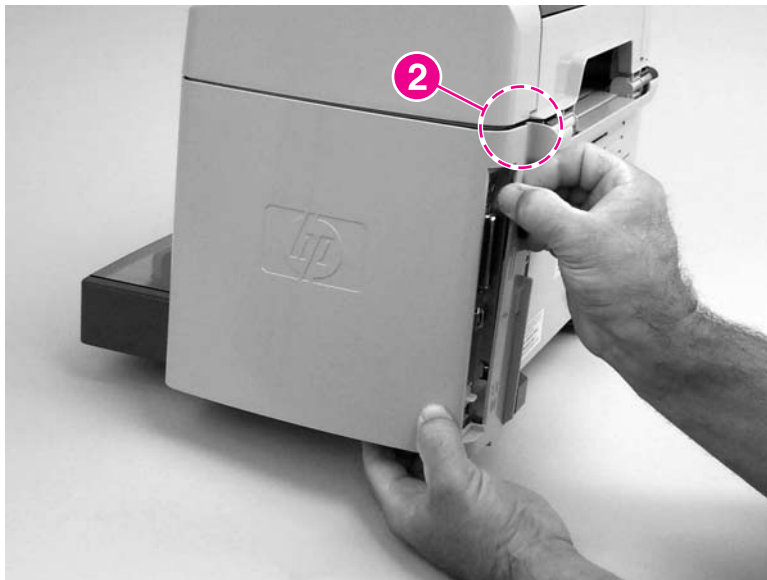
### Remove the scanner assembly (2 of 15)

3. Remove the right-side cover-mounting screw (callout 1).



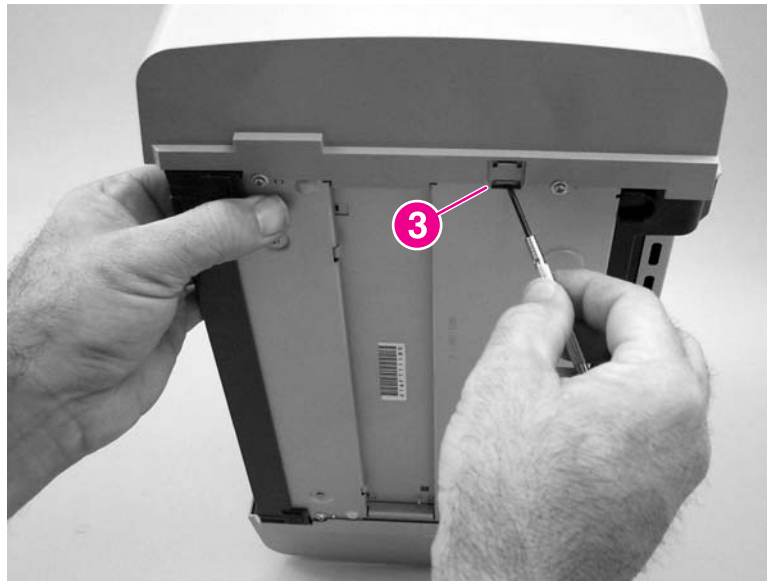
**Figure 5-26.** Remove the scanner assembly (3 of 15)

4. Release the upper-back (callout 2).



**Figure 5-27.** Remove the scanner assembly (4 of 15)

5. Release the bottom tab (callout 3).



**Figure 5-28.** Remove the scanner assembly (5 of 15)

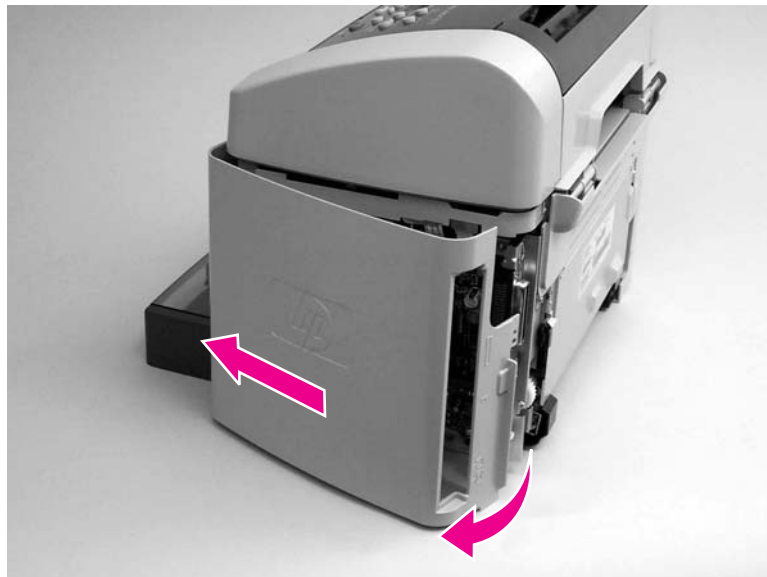
6. Rotate the back side of the cover away from the product, and then slide the cover toward the front of the product to remove it

---

**CAUTION**

---

Make sure that the parallel connector bales are in the closed position. If they are in the open position, they might spring off when the cover is removed and be misplaced.

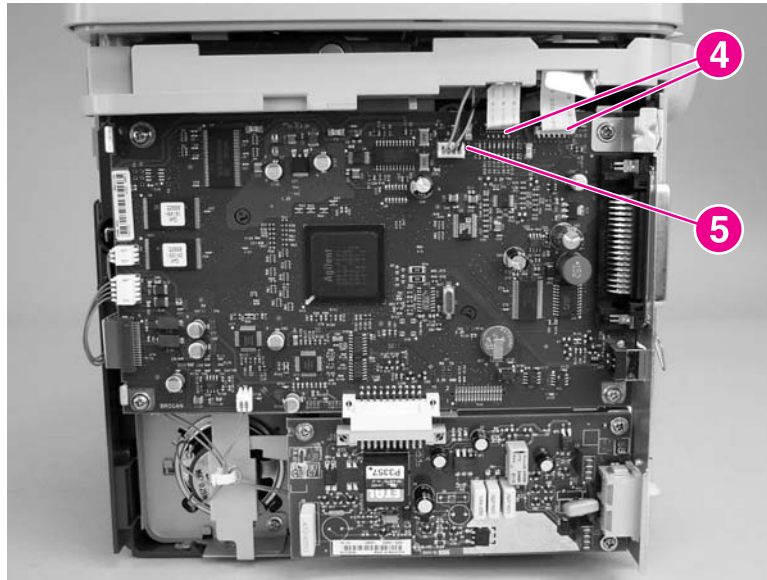


**Figure 5-29.** Remove the scanner assembly (6 of 15)

7. Disconnect two flat flexible cables (FFCs; callout 4) and one wire-harness connector (callout 5).

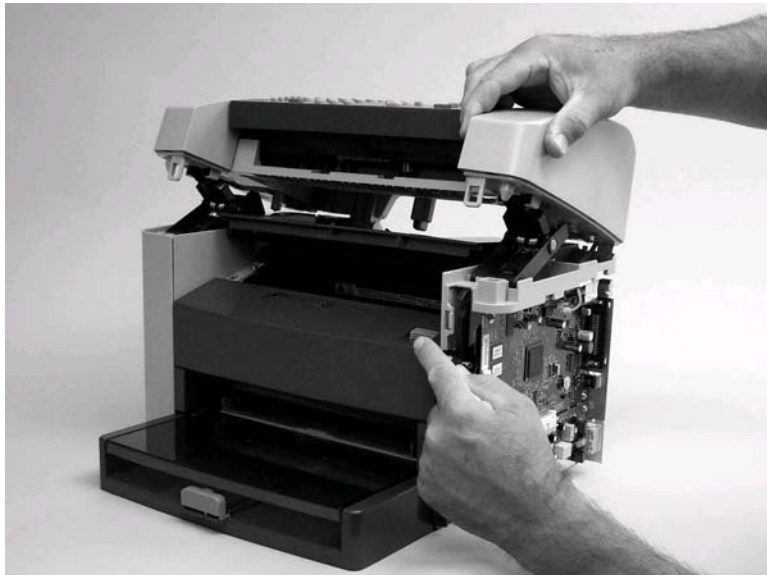
**CAUTION**

Do not bend or fold the FFCs during the removal or reinstallation process.



**Figure 5-30.** Remove the scanner assembly (7 of 15)

8. Push the blue print cartridge door release button and then raise the scanner assembly until it locks open.



**Figure 5-31.** Remove the scanner assembly (8 of 15)

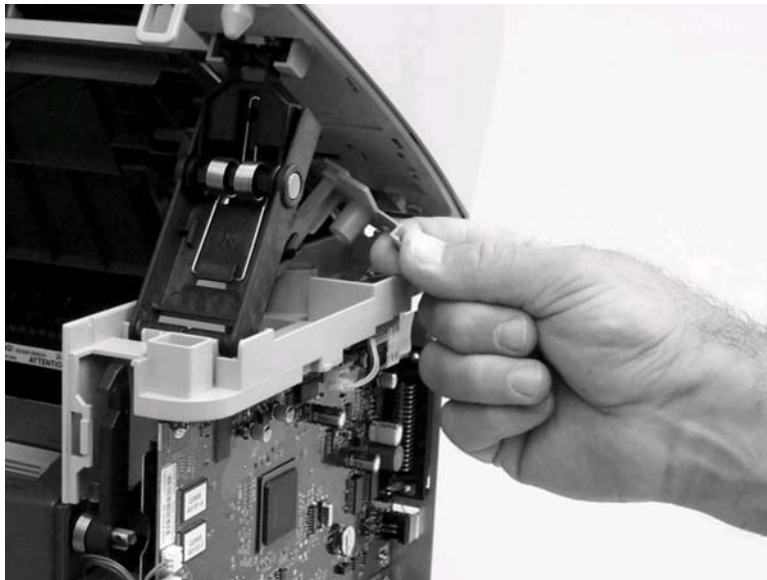


9. Grasp the tab on the gear-drive arm bracket and carefully flex it away from the scanner assembly to release the bracket.



**Figure 5-32.** Remove the scanner assembly (9 of 15)

10. Pull the bracket toward the right side of the product until its mounting tabs clear the holes in the scanner assembly.



**Figure 5-33.** Remove the scanner assembly (10 of 15)



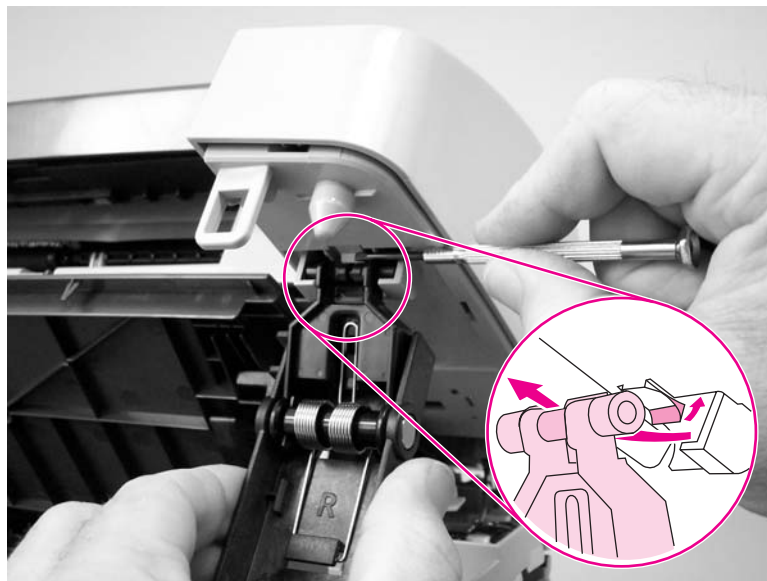
11. Use a small flat-blade screwdriver to release the link tabs on each link assembly.

**WARNING!**

When the link assemblies are disengaged, the scanner assembly can easily fall off of the product base if it is rotated too far towards the back of the product.

**CAUTION**

Do not push too hard on the link tabs or the tabs might break.



**Figure 5-34.**

**Remove the scanner assembly (11 of 15)**

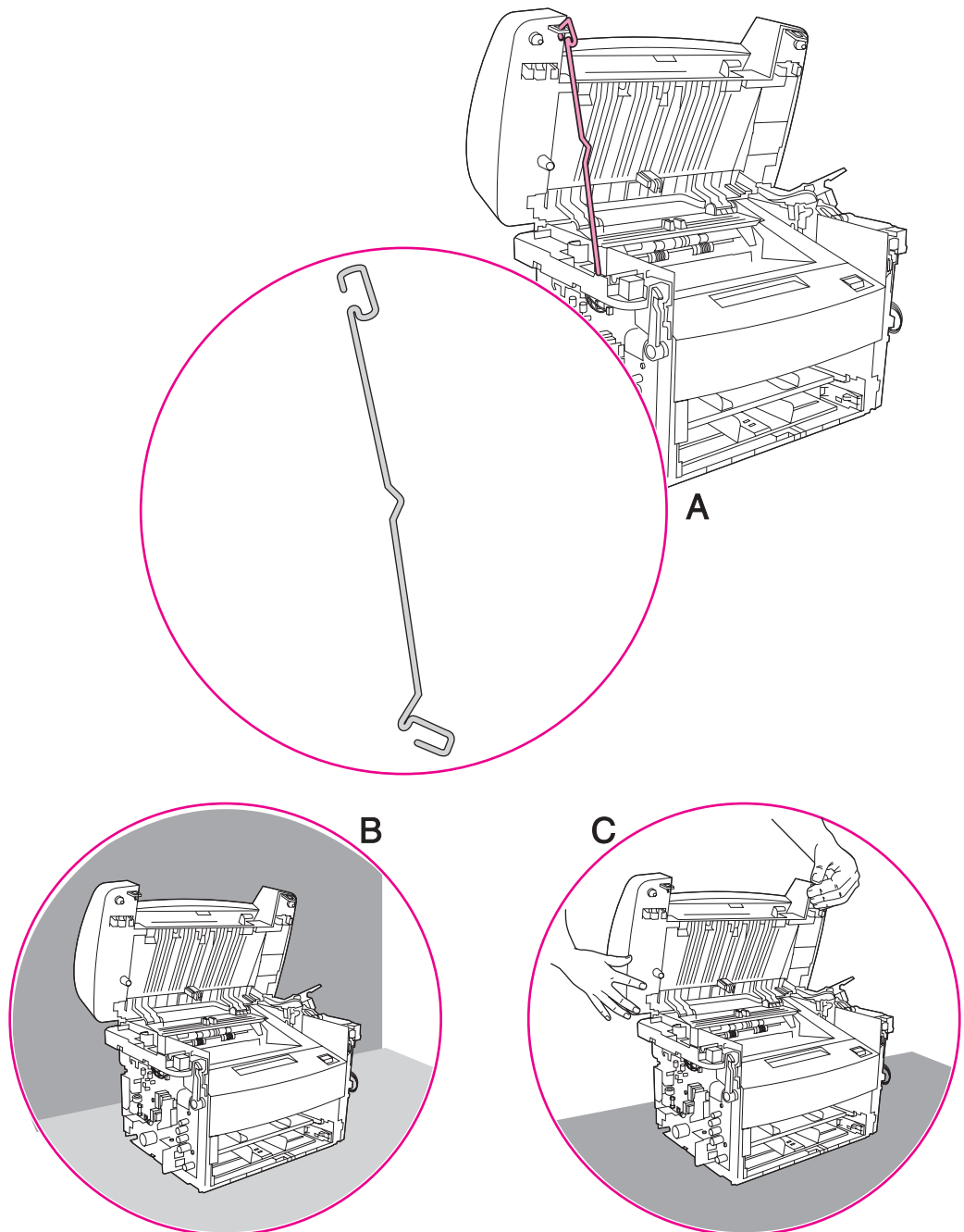
12. Use one of the following three separate methods to support the scanner assembly so that it does not fall off of the product base.

- **A** Use the HP scanner-support tool (part number: 5185-7441).

**Note**

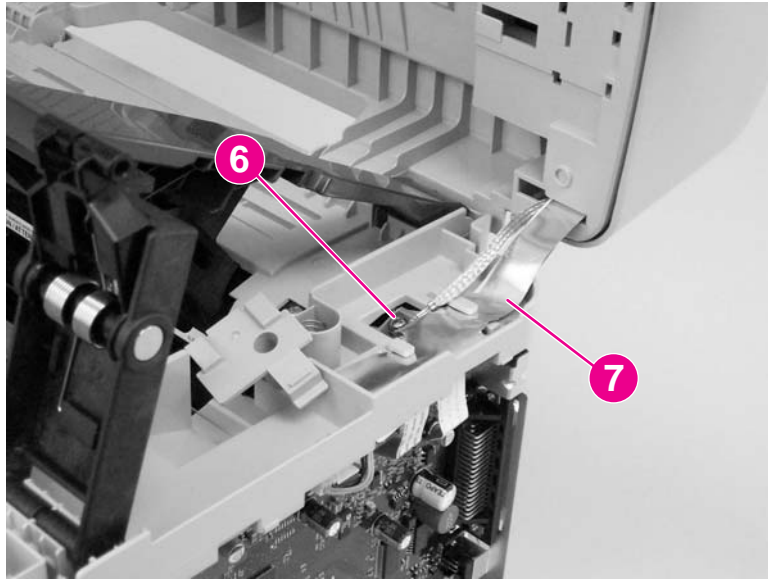
Remove the left-side link before using the support tool.

- **B** Rest the scanner assembly against a wall.
- **C** Rest the scanner assembly against your chest



**Figure 5-35.** Remove the scanner assembly (12 of 15)

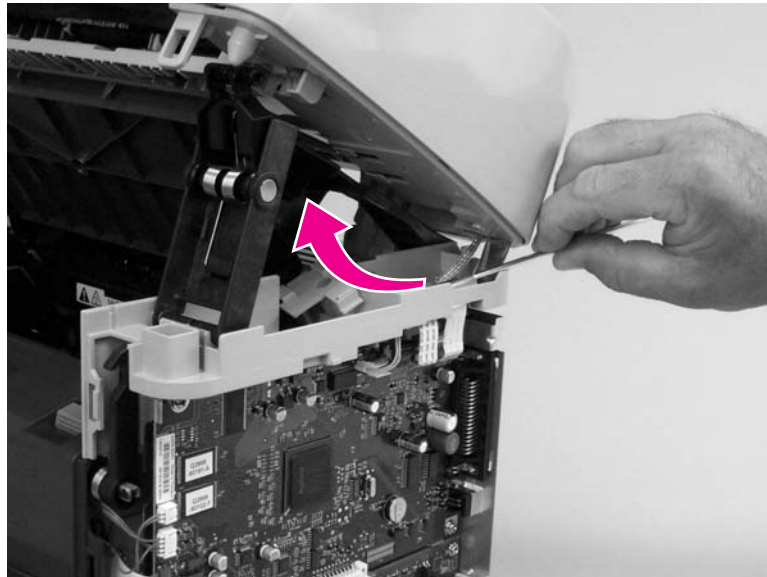
13. Remove one screw (callout 6). Carefully remove the grounding shield (callout 7) from the wire loom. Feed the two FFCs and the wire-harness through the hole in the chassis, and remove them from the wire loom.



**Figure 5-36.** Remove the scanner assembly (13 of 15)

**Hint**

To remove the grounding shield easily, insert the shaft of a long flat-blade screwdriver under the shield at the edge of the chassis. Pull up on the screwdriver shaft to release the shield, and then remove the shield from the wire loom.



**Figure 5-37.** Remove the scanner assembly (14 of 15)

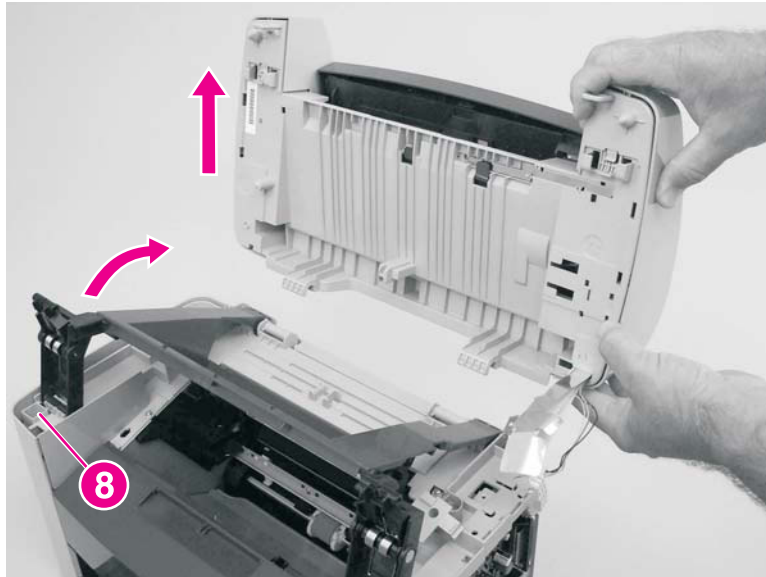
14. Rotate the scanner assembly toward the rear of the product until the rear hinges clear the chassis hinge pins. Lift the scanner assembly off of the product base.

---

**Note**

---

Do not lose the two scanner cushions located in the scanner support frame (callout 8; left side location shown).



**Figure 5-38.** Remove the scanner assembly (15 of 15)

### Scanner assembly top cover

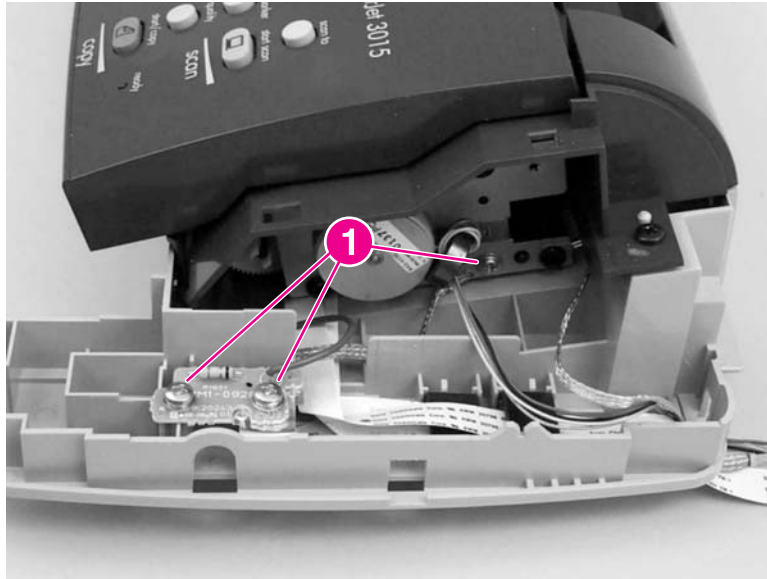
1. Remove the following assemblies or components.
  - Scanner assembly. See [Scanner assembly](#).
  - Scanner side covers. See [Scanner side covers](#).

2. Remove three screws (callout 1): two PCB screws and one grounding screw.

---

**CAUTION**

The PCB is an ESD-sensitive component.



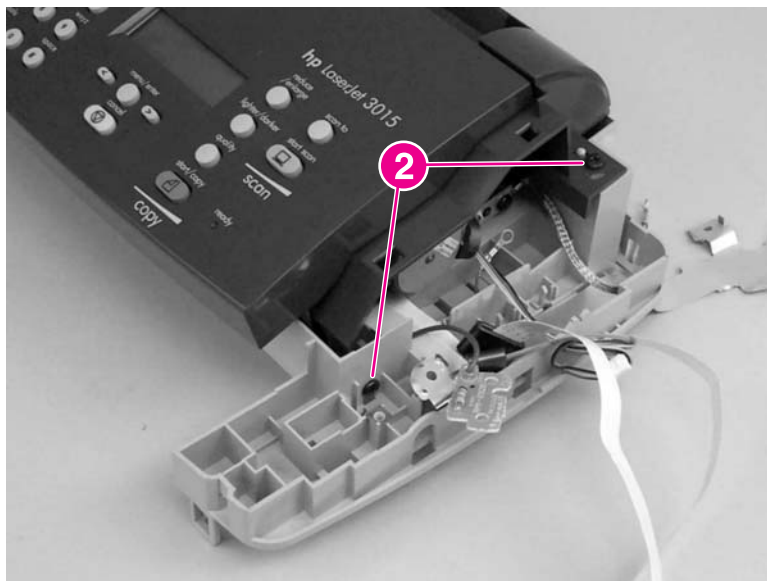
**Figure 5-39.** Remove the scanner assembly top cover (1 of 4)

3. Feed the two FFCs, the wire connector, and the ground strap through the opening in the scanner-assembly base and remove two right-side mounting screws (callout 2).

---

**CAUTION**

Take note of how the FFCs and wire-harnesses are routed *before* moving them.  
Do not bend or fold the FFCs during the removal or reinstallation process.



**Figure 5-40.** Remove the scanner assembly top cover (2 of 4)

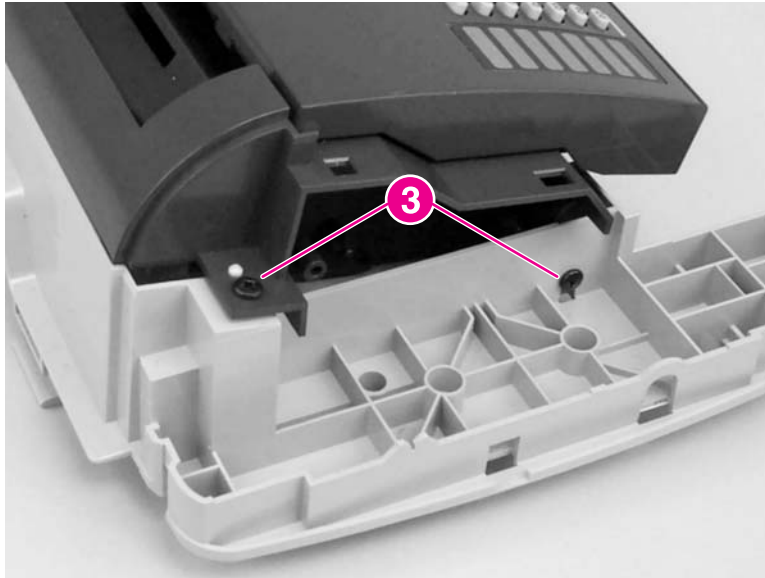
### Reinstallation tip

When reinstalling the FFCs, make sure that the ferrites snap into the clips in the base.

4. Remove the two left-side mounting screws (callout 3).

### Reinstallation tip

When reinstalling the scanner assembly top cover make sure that it is seated on the alignment pins (the plastic pin is behind the screw [callout 3] in the following figure).



**Figure 5-41.** Remove the scanner assembly top cover (3 of 4)

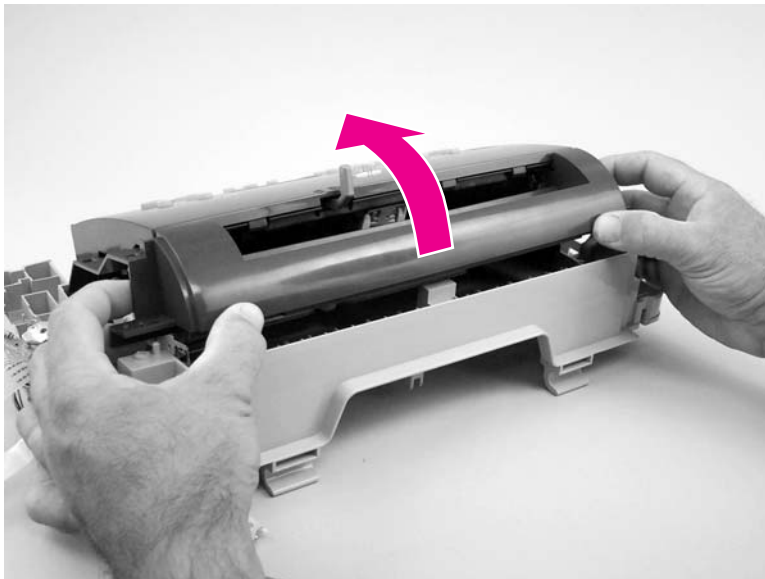
5. Lift up on the scanner assembly top cover to separate it from the base frame assembly.

---

### CAUTION

---

Separating the scanner assembly top cover from the base frame assembly might require considerable force. Be careful to not damage or drop either assembly when they separate.

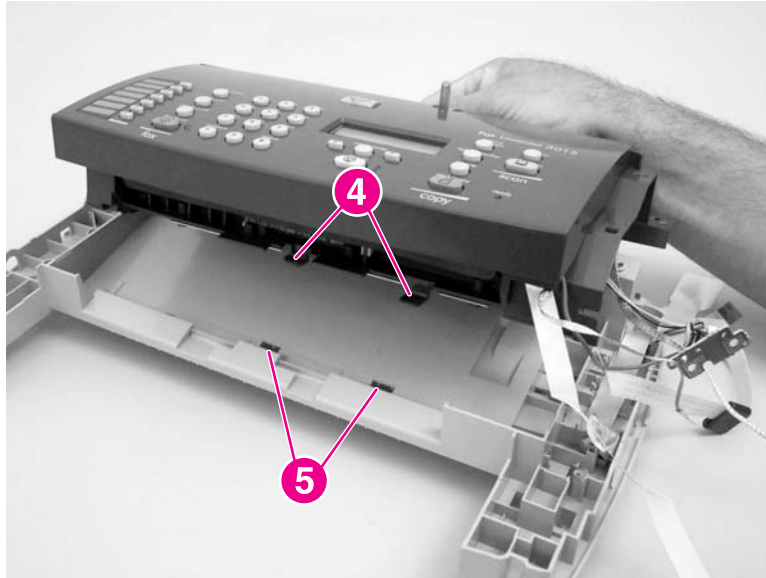


**Figure 5-42.** Remove the scanner assembly top cover (4 of 4)

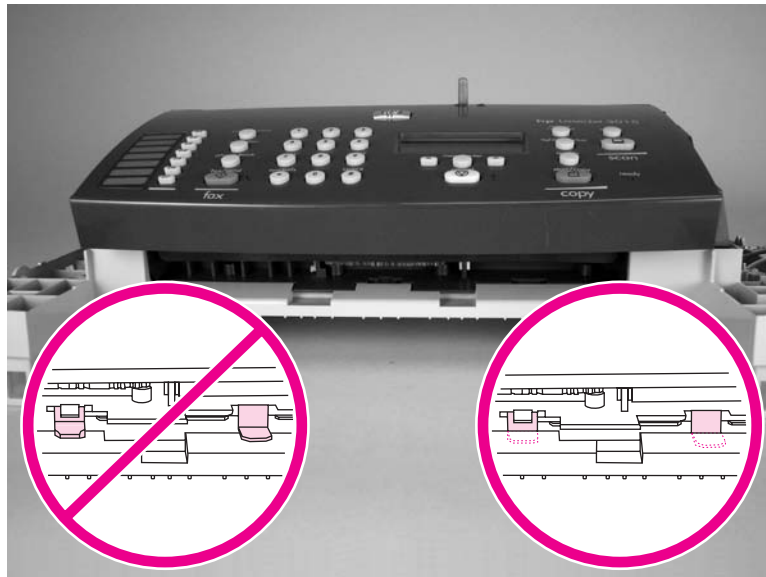
## Reinstallation tip

When installing the scanner assembly top cover, verify that the two tabs (callout 4) along the front-bottom edge of the assembly fit into the corresponding slots in the base frame (callout 5).

When installing the scanner assembly top cover, verify that the FFCs and wire-harnesses are clear and will not be pinched by the assembly.



**Figure 5-43.** Reinstalling the scanner assembly top cover



**Figure 5-44.** Align the scanner assembly top cover and base

## Top-cover assembly

1. Remove the following assemblies.
  - Scanner assembly See [Scanner assembly](#).
  - Scanner assembly top cover. See [Scanner assembly top cover](#).

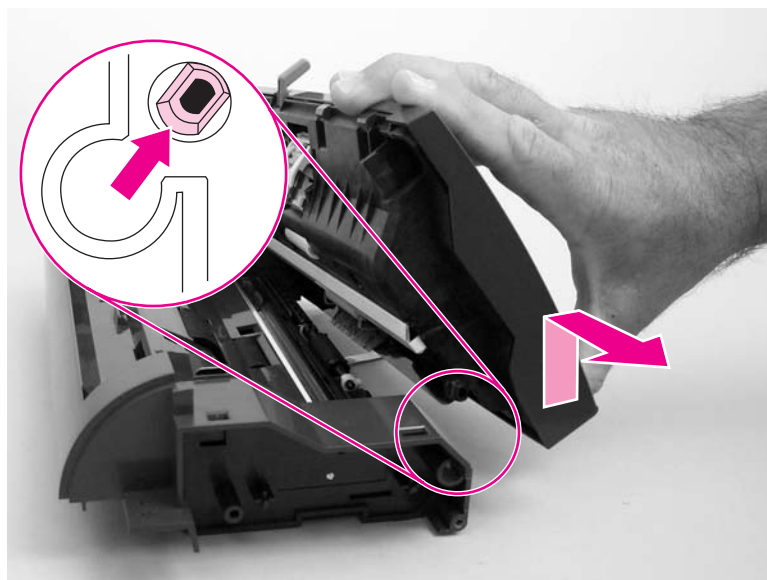


2. Rotate the top-cover assembly (callout 1) away from the frame assembly (callout 2).



**Figure 5-45.** Remove the top-cover assembly (1 of 2)

3. Pull the left-end hinge out of the slot in the frame assembly, and slide the top cover to the left until the right-side hinge clears the hole in the frame assembly. Remove the top cover.



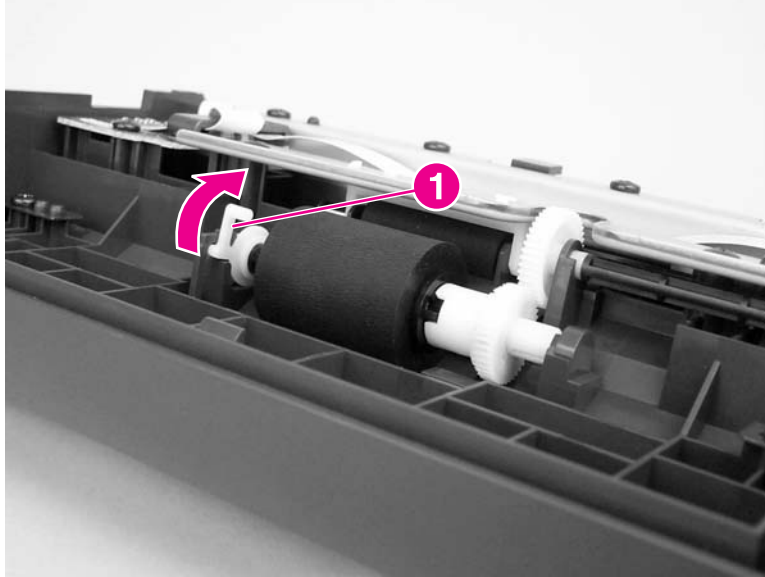
**Figure 5-46.** Remove the top-cover assembly (2 of 2)

## Pickup roller

1. Remove the following assemblies.
  - Scanner assembly. See [Scanner assembly](#).
  - Scanner top cover assembly. See [Top-cover assembly](#).

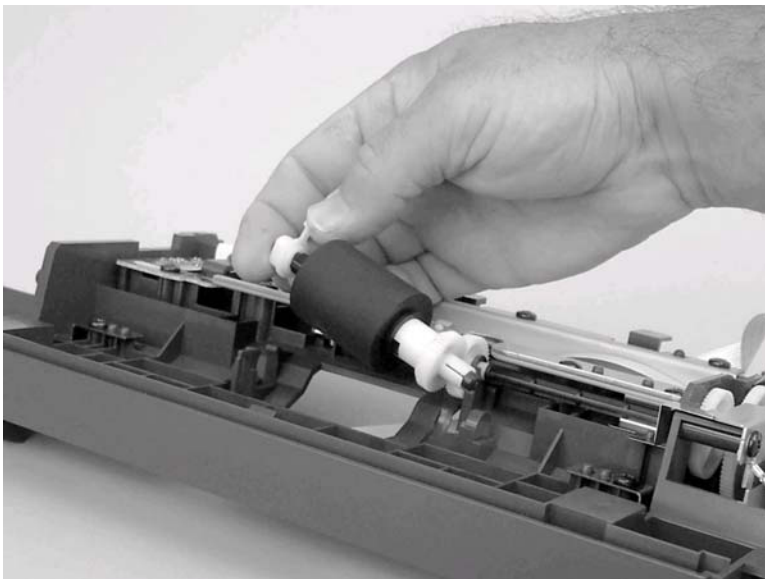


2. Unclip the pickup-roller retainer (callout 1) and rotate it until the flat sides of the clip align with the mounting slot on the frame assembly.



**Figure 5-47.** Remove the pickup roller (1 of 2)

3. Lift the right side of the pickup roller shaft out of the mounting slot, and then pull it to the right until the left end of the shaft clears the mounting hole on the left side of the frame assembly.

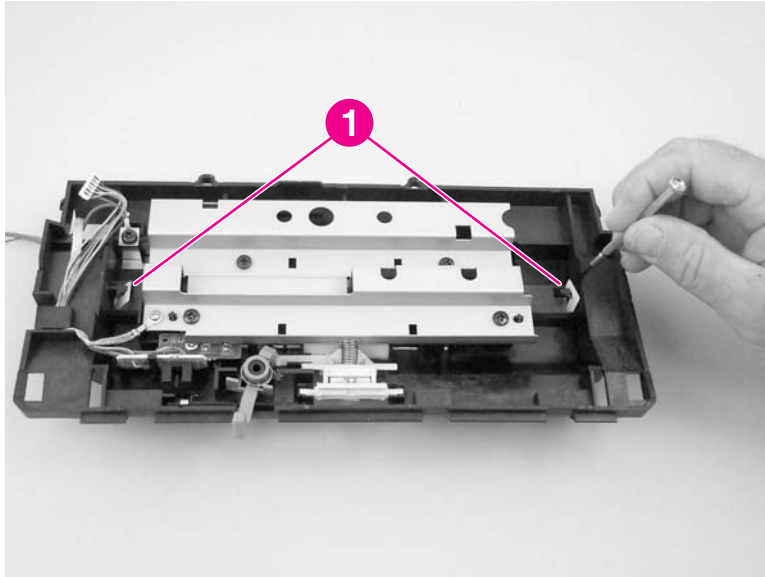


**Figure 5-48.** Remove the pickup roller (2 of 2)

## White platen

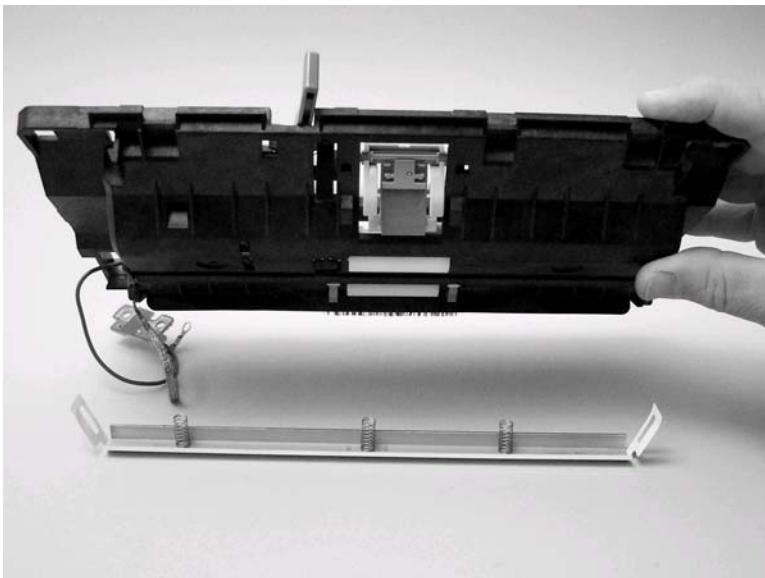
1. Remove the following assemblies.
  - Scanner assembly. See [Scanner assembly](#)
  - Scanner assembly top cover. See [Top-cover assembly](#)
  - Top-cover assembly. See [Top-cover assembly](#)

2. Use a small flat-blade screwdriver to carefully pry the white-platen retainer tabs (callout 1) off of the posts on the guide assembly.



**Figure 5-49.** Remove the white platen (1 of 2)

3. Lift the guide assembly up and off of the white platen.



**Figure 5-50.** Remove the white platen (2 of 2)

### **Reinstallation tip**

When replacing the white platen, verify that the beveled edge faces the cover-pad side of the guide assembly.

## HP LaserJet 3020 and 3030 all-in-one

This section documents removal and replacement instructions for components that are unique to the HP LaserJet 3020 and 3030 product.

### Note

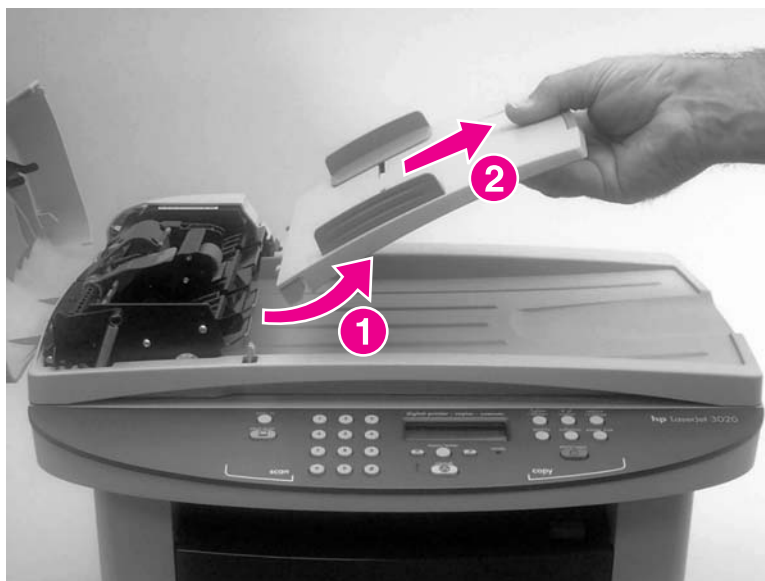
The scanner assembly might be contaminated if it is opened outside of a cleanroom environment. For this reason, the entire scanner assembly is replaceable only as a unit. Replacing the scanner assembly as an entire assembly replaces the CIS or CCD scan module, the CCD scan motor, and the cable. If the ADF fails, it too is replaceable only as an entire assembly. Replacing the ADF replaces the ADF cable and other ADF submechanisms.

ADF input tray  
Flatbed lid  
HP LaserJet 3020 and 3030 scanner assembly  
Link assemblies and scanner support frame springs  
Control-panel bezel  
Control-panel assembly  
Separation pad assembly  
ADF input-tray flag  
Pickup roller assembly  
ADF glass

**Figure 5-51.** Parts removal order HP LaserJet 3020 and 3030 scanner assembly

### ADF input tray

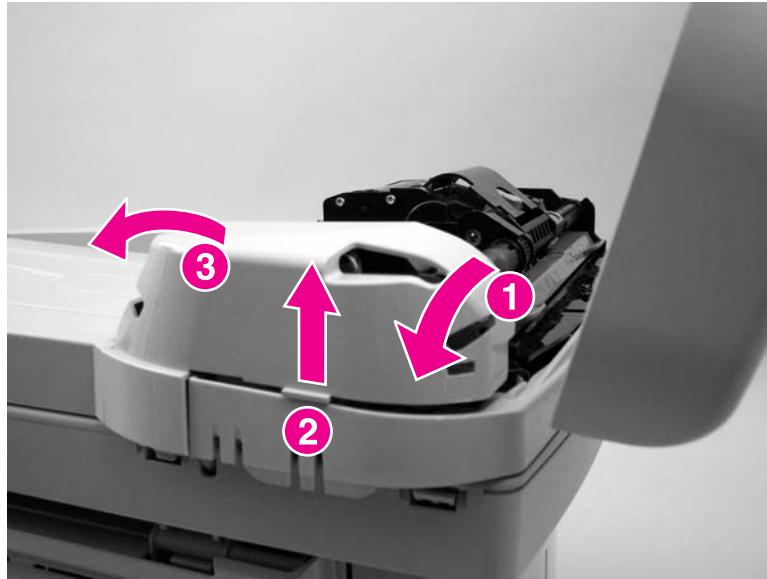
1. Open the ADF lid and grasp the ADF input tray. Rotate the paper tray up and pull it away from the ADF.



**Figure 5-52.** Remove the ADF input tray

## Flatbed lid

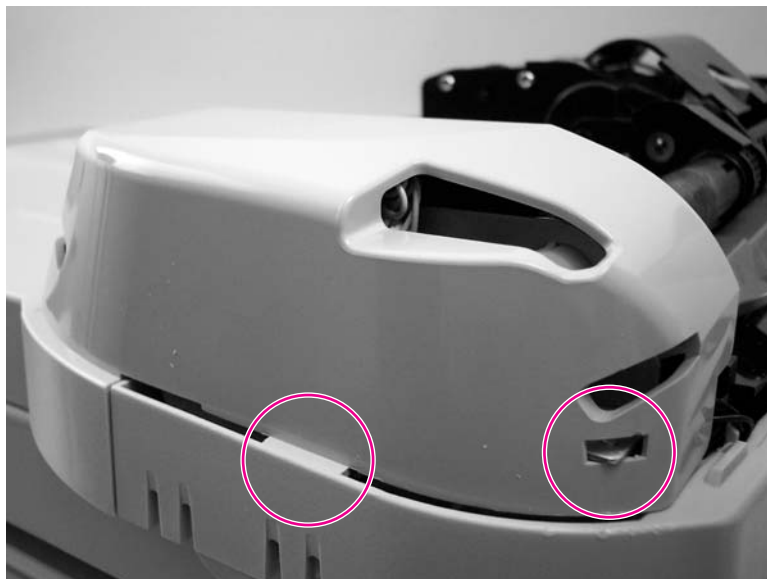
1. Open the ADF cover. Carefully pry the ADF motor cover off (from right to left) and away from the scanner assembly.



**Figure 5-53.** Remove the flatbed lid (1 of 5)

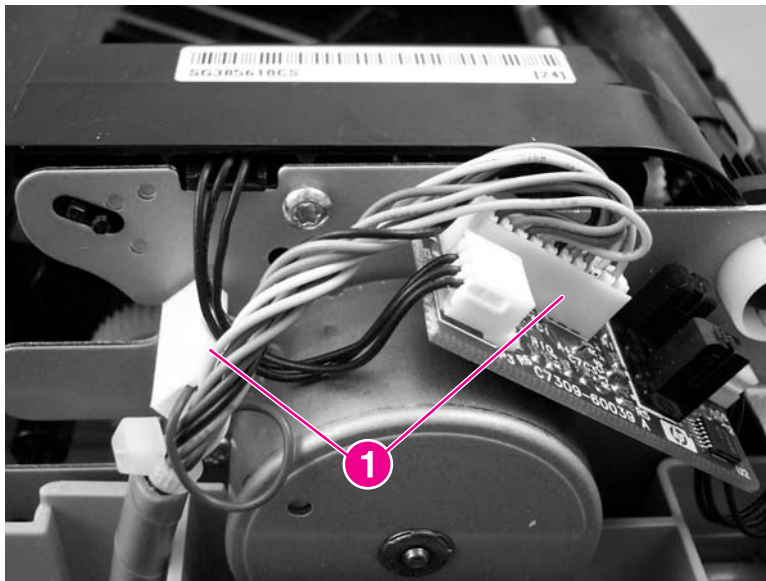
### Reinstallation tip

When the ADF motor cover is reinstalled, make sure it is positioned correctly. If the motor cover is not installed properly, the ADF lid will not close properly, resulting in intermittent ADF errors. Verify that the plastic tab fits into the slot and that the motor cover snaps over the corner of the sheet metal chassis.



**Figure 5-54.** ADF cover correctly installed

2. Disconnect two wire connectors (callout 1). Close the ADF cover.



**Figure 5-55.** Remove the flatbed lid (2 of 5)

3. Locate the hinge-retainer clip on the far-left flatbed hinge (this hinge is the one above the parallel connector).



**Figure 5-56.** Remove the flatbed lid (3 of 5)

4. Lift up on the retainer-clip locking tab, and pull the clip down and away from the flatbed lid.



**Figure 5-57.** Remove the flatbed lid (4 of 5)

5. Raise the flatbed scanner lid until the hinges can clear the hinge posts on the scanner bed, and then remove the flatbed lid from the scanner assembly.

---

**CAUTION**

---

Avoid touching the flatbed glass or the ADF separation pad. Skin oils and fingerprints can contaminate the glass or pad and cause print quality problems.



**Figure 5-58.** Remove the flatbed lid (5 of 5)

### **Link assemblies and scanner support frame springs**

1. Push the print-cartridge access button and raise the the scanner assembly until it is locked open.

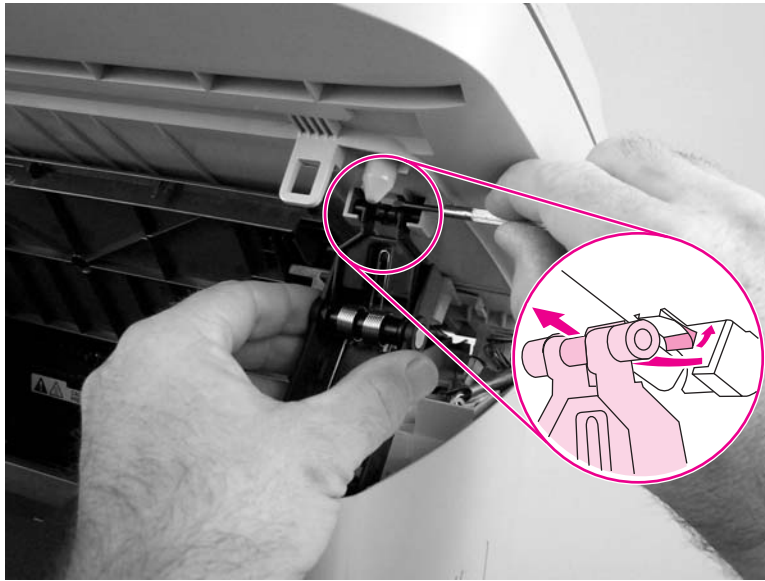
2. Use a small flat-blade screwdriver to release the link tabs on each link assembly.

**WARNING!**

When the link assemblies are disengaged, the scanner assembly can easily fall off of the product base if it is rotated too far towards the back of the product.

**CAUTION**

Do not push too hard on the link tabs or the tabs might break.



**Figure 5-59.**

**Remove the link assemblies and scanner support frame springs (1 of 4)**

3. Rotate a link assembly toward the front of the printer until the link disengages from the scanner support frame.



**Figure 5-60.**

**Remove the link assemblies and scanner support frame springs (2 of 4)**



4. Remove the link assembly. Repeat this step with the remaining link.



**Figure 5-61.** Remove the link assemblies and scanner support frame springs (3 of 4)

5. Use needle nose pliers to remove the scanner support frame spring. Repeat this step for the other scanner support frame spring.

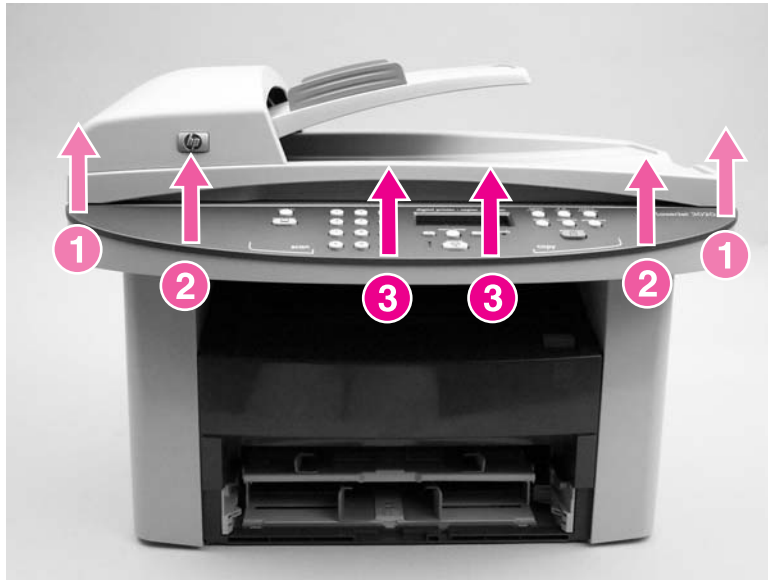


**Figure 5-62.** Remove the link assemblies and scanner support frame springs (4 of 4)



## Control-panel bezel

1. Gently pry up the outside edge of the control-panel bezel to release it.



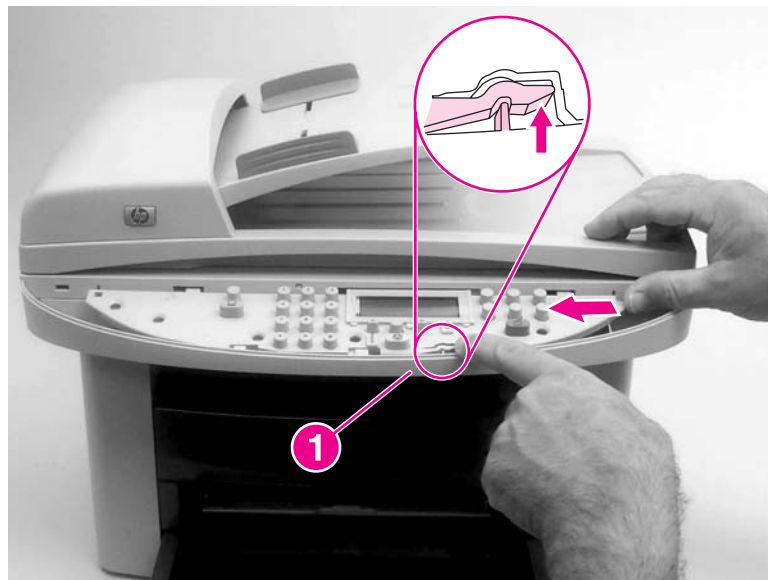
**Figure 5-63.** Remove the control-panel bezel

## Control-panel assembly

### CAUTION

The control-panel is an ESD-sensitive component.

1. Remove the control-panel bezel. See [Control-panel bezel](#).
2. Push in on the control-panel assembly latch (callout 1), and slide the assembly to the left to release it..



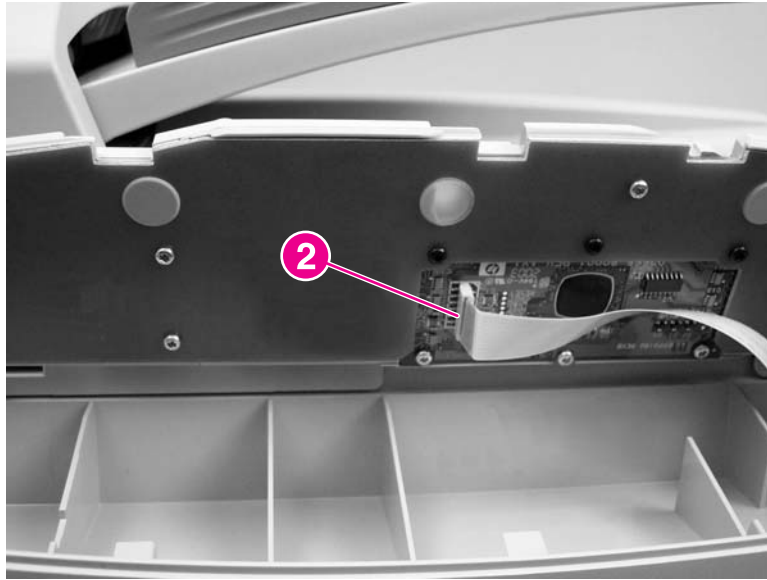
**Figure 5-64.** Remove the control panel assembly (1 of 2)

3. Slightly lift up the control panel and disconnect 1 FFC (callout 2). Remove the control-panel assembly

---

**CAUTION**

Do not bend or fold the FFCs during the removal or reinstallation process.



**Figure 5-65.** Remove the control panel assembly (2 of 2)

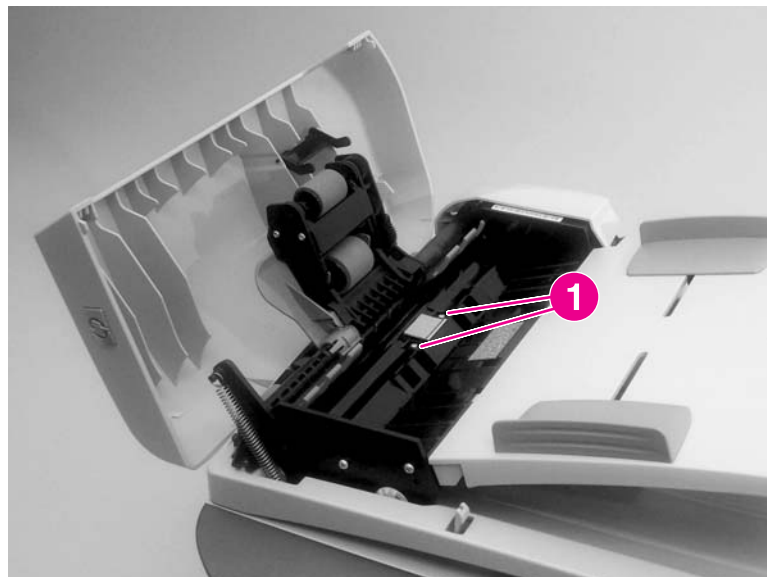
## ADF separation pad

---

**CAUTION**

Avoid touching the flatbed glass or the ADF separation pad. Skin oils and fingerprints can contaminate the glass or pad and cause print quality or paper pickup problems.

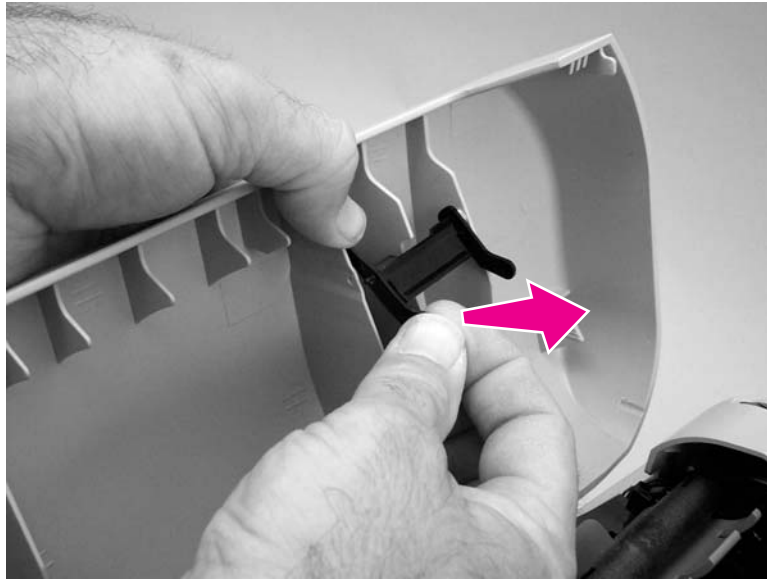
1. Open the ADF cover and lift up the ADF pickup-roller assembly.
2. Use a #8 torx screwdriver to remove two torx screws (callout 1) and remove the separation-pad assembly.



**Figure 5-66.** Remove the separation pad

## ADF input-tray flag

1. Open the ADF cover.
2. Gently flex the plastic rib that retains the flag hinge until the front flag hinge clears the mounting hole. Rotate the ADF input-flag until the hinge pin clears the plastic rib. Pull the flag towards you to release the back hinge.

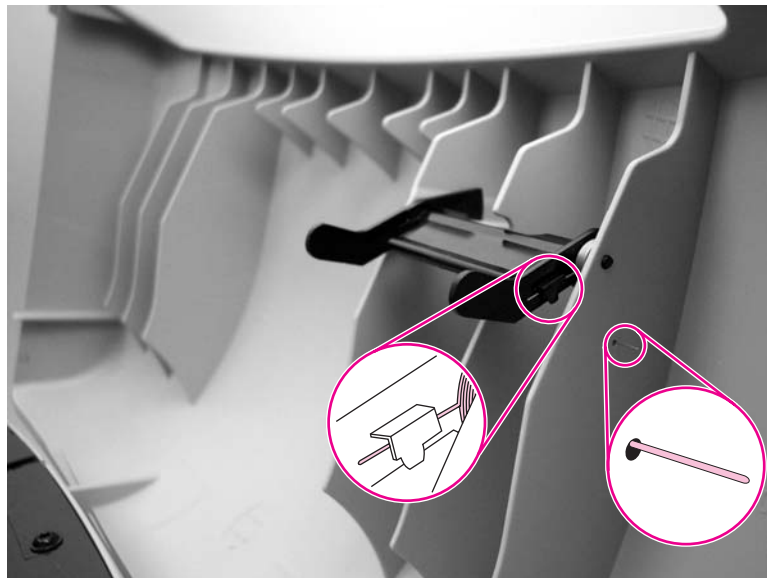


**Figure 5-67.** Remove the ADF input-tray flag

### Reinstallation tip

When reinstalling the ADF input-tray flag, make sure that the long, straight end of the spring is tucked under the lip on the flag and that the bent end of the spring threads through the hole in the plastic rib that retains the flag.

Make sure that the ADF input-tray flag can move freely.



**Figure 5-68.** Correct positioning of the ADF input-tray spring

## ADF pickup roller

---

### CAUTION

---

Avoid touching the flatbed glass or the ADF separation pad. Skin oils and fingerprints can contaminate the glass or pad and cause print quality or paper pickup problems.

1. Open the ADF lid.
2. Press the round, green button while lifting the green lever. Rotate the green lever until it stops in the open position. The pickup roller assembly will remain on the black surface.



**Figure 5-69.** Remove the ADF pickup roller (1 of 2)

3. Remove the pickup-roller assembly, and put the replacement assembly in exactly the same place. The larger roller goes in back, and the gear side faces the scanner motor cover.

---

### Note

---

When installing the pickup roller assembly, make sure that the gear side of the roller assembly is positioned toward the back of the product.



**Figure 5-70.** Remove the ADF pickup roller (2 of 2)

## ADF scanner glass

### CAUTION

Avoid touching the flatbed glass or the ADF separation pad. Skin oils and fingerprints can contaminate the glass or pad and cause print quality or paper pickup problems.

1. Use a #10 torx screwdriver to remove one torx screw.



Figure 5-71.

### Remove the ADF scanner glass (1 of 3)

2. Carefully remove the plastic ADF scanner-glass frame.



Figure 5-72.

### Remove the ADF scanner glass (2 of 3)

3. Slide the black glass-locking lever toward the back of the product to release the glass, and then carefully remove the glass.

---

**CAUTION**

---

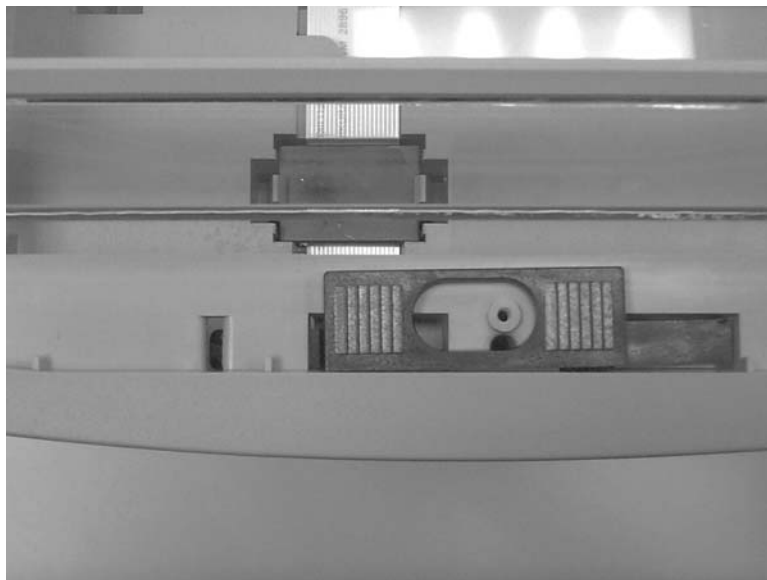
Avoid touching the flatbed glass or the ADF separation pad. Skin oils and fingerprints can contaminate the glass or pad and cause print quality or paper pickup problems.



**Figure 5-73.** Remove the ADF scanner glass (3 of 3)

### Reinstallation tip

Replace the glass first, and then install the frame. Press down on the frame and glass until the lock mechanism snaps back into the locked position as shown in [Figure 5-74. Install the ADF scanner glass.](#)



**Figure 5-74.** Install the ADF scanner glass

## Scanner assembly

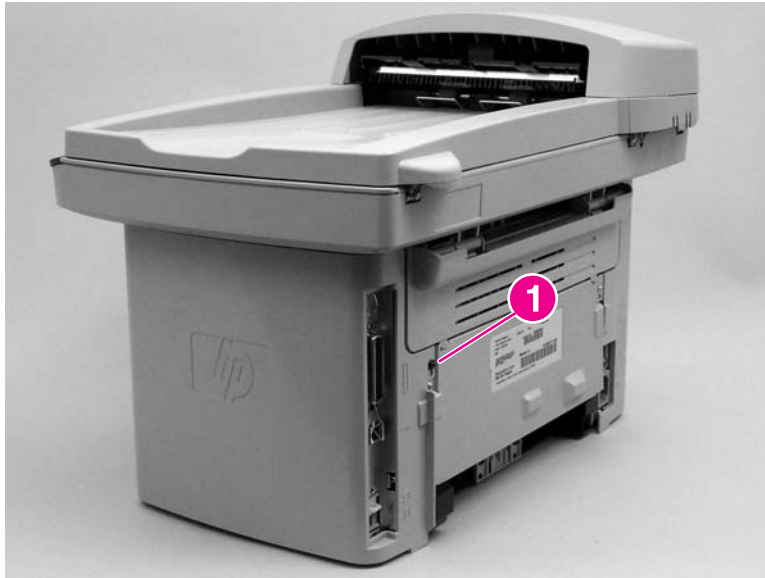
### CAUTION

Avoid touching the flatbed glass or the ADF separation pad. Skin oils and fingerprints can contaminate the glass or pad and cause print quality or paper pickup problems.

### Note

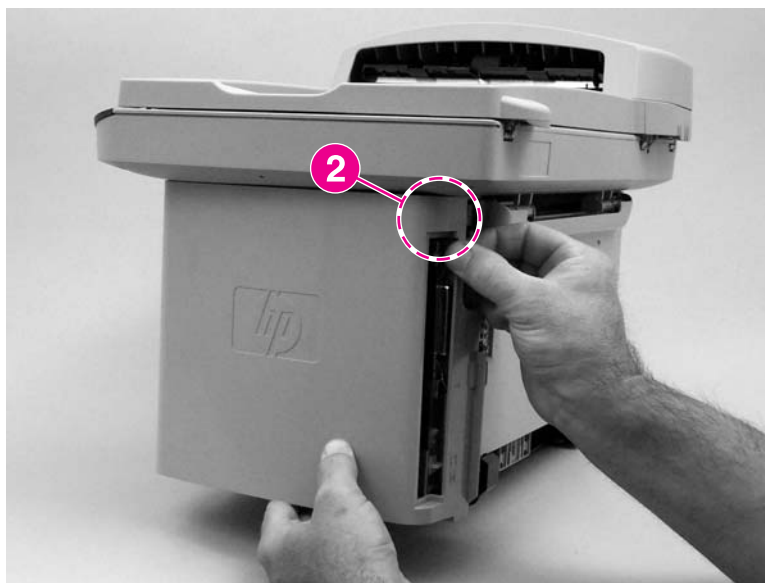
It is not necessary to remove the flatbed lid before removing the scanner assembly. However, removing the flatbed lid will make the scanner assembly lighter and easier to handle when it is removed. To remove the flatbed lid, see [Flatbed lid](#).

1. Remove the ADF input tray. See [ADF input tray](#).
2. Remove one screw (callout 1).



**Figure 5-75.** Remove the scanner assembly (1 of 13)

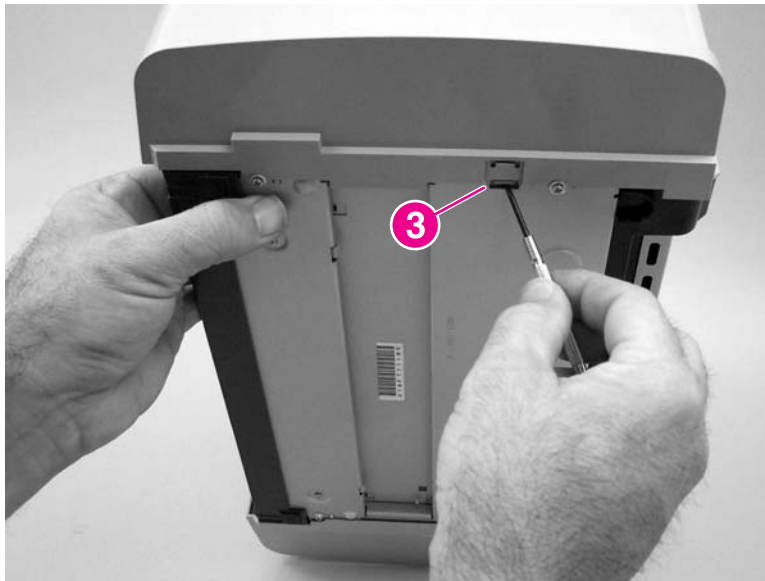
3. Release the upper-back (callout 2).



**Figure 5-76.** Remove the scanner assembly (2 of 13)



4. Release the bottom tab (callout 3).



**Figure 5-77.** Remove the scanner assembly (3 of 13)

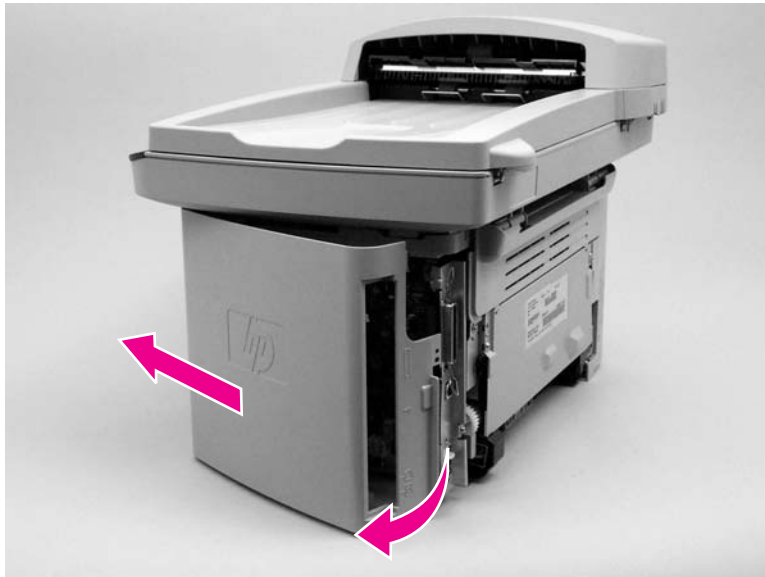
5. Rotate the back side of the cover away from the product, and then slide the cover toward the front of the product to remove it.

---

**CAUTION**

---

Make sure that the parallel connector bales are in the closed position. If they are in the open position, they might spring off when the cover is removed and be lost.



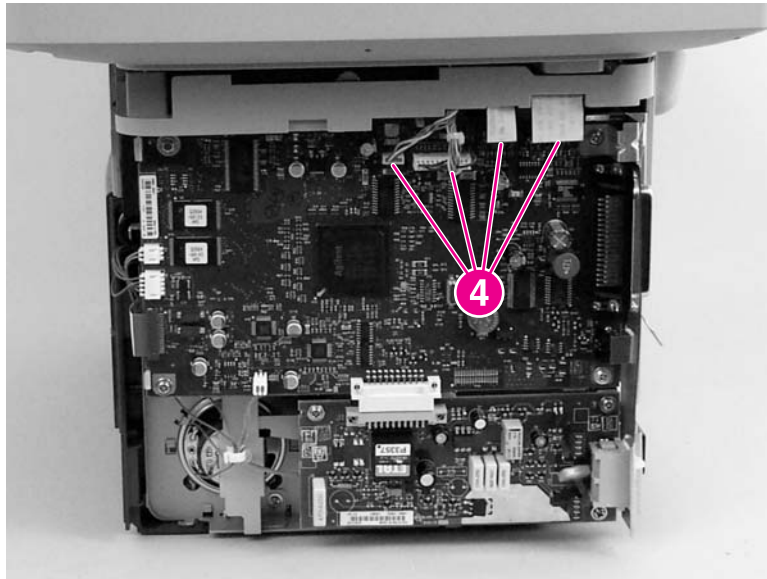
**Figure 5-78.** Remove the scanner assembly (4 of 13)



6. Disconnect two wire-harnesses and two FFCs on the formatter (callout 4).

**CAUTION**

Do not bend or fold the FFCs during the removal or reinstallation process.



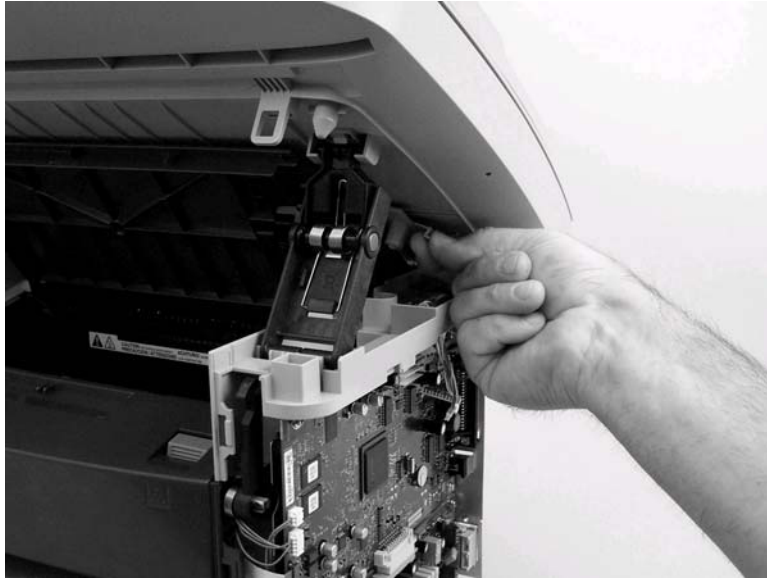
**Figure 5-79.** Remove the scanner assembly (5 of 13)

7. Push the print-cartridge door button to release the scanner assembly, and then raise the assembly until it locks open.



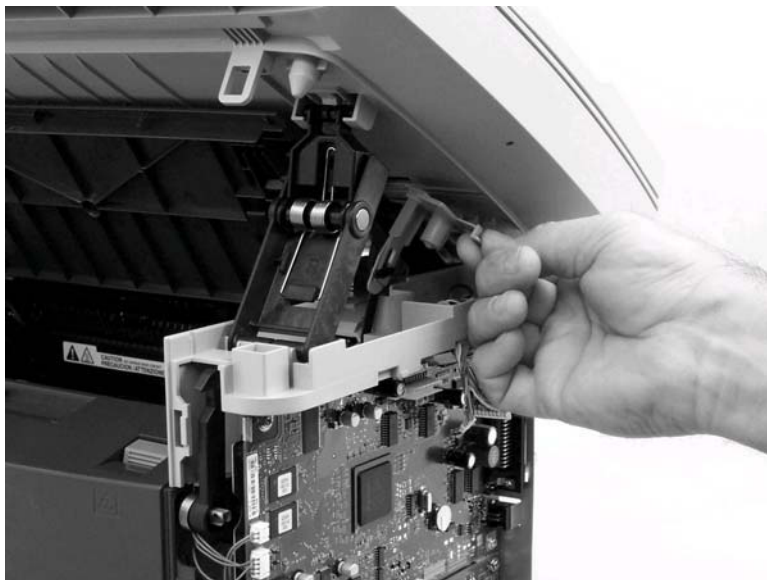
**Figure 5-80.** Remove the scanner assembly (6 of 13)

8. Grasp the tab on the gear-drive arm bracket and carefully flex it away from the scanner assembly to release the bracket.



**Figure 5-81.** Remove the scanner assembly (7 of 13)

9. Pull the bracket toward the right side of the product until its mounting tabs clear the holes in the scanner assembly.



**Figure 5-82.** Remove the scanner assembly (8 of 13)

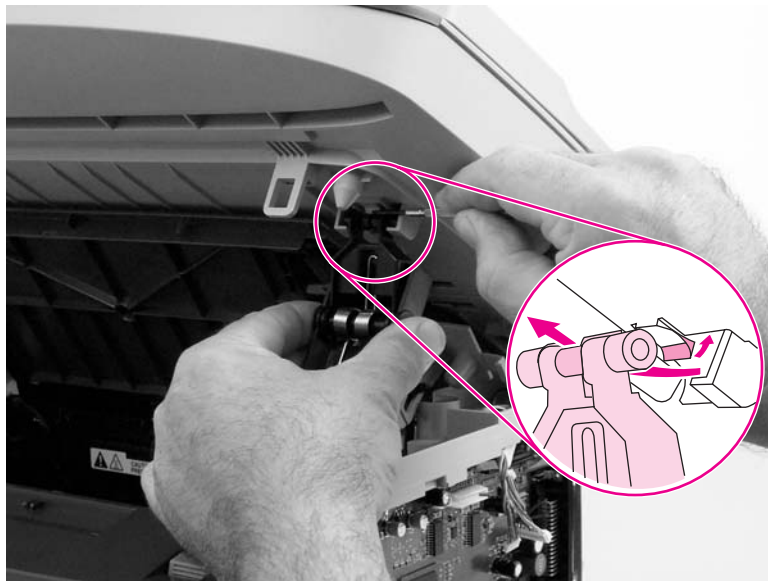
10. Use a small flat-blade screwdriver to release the hinge tabs on each front hinge.

**WARNING!**

When the front hinges are disengaged, the scanner assembly can easily fall off of the product base if it is rotated too far toward the back of the product.

**CAUTION**

Do not push too hard on the link tabs or the tabs might break.



**Figure 5-83.**

**Remove the scanner assembly (9 of 13)**

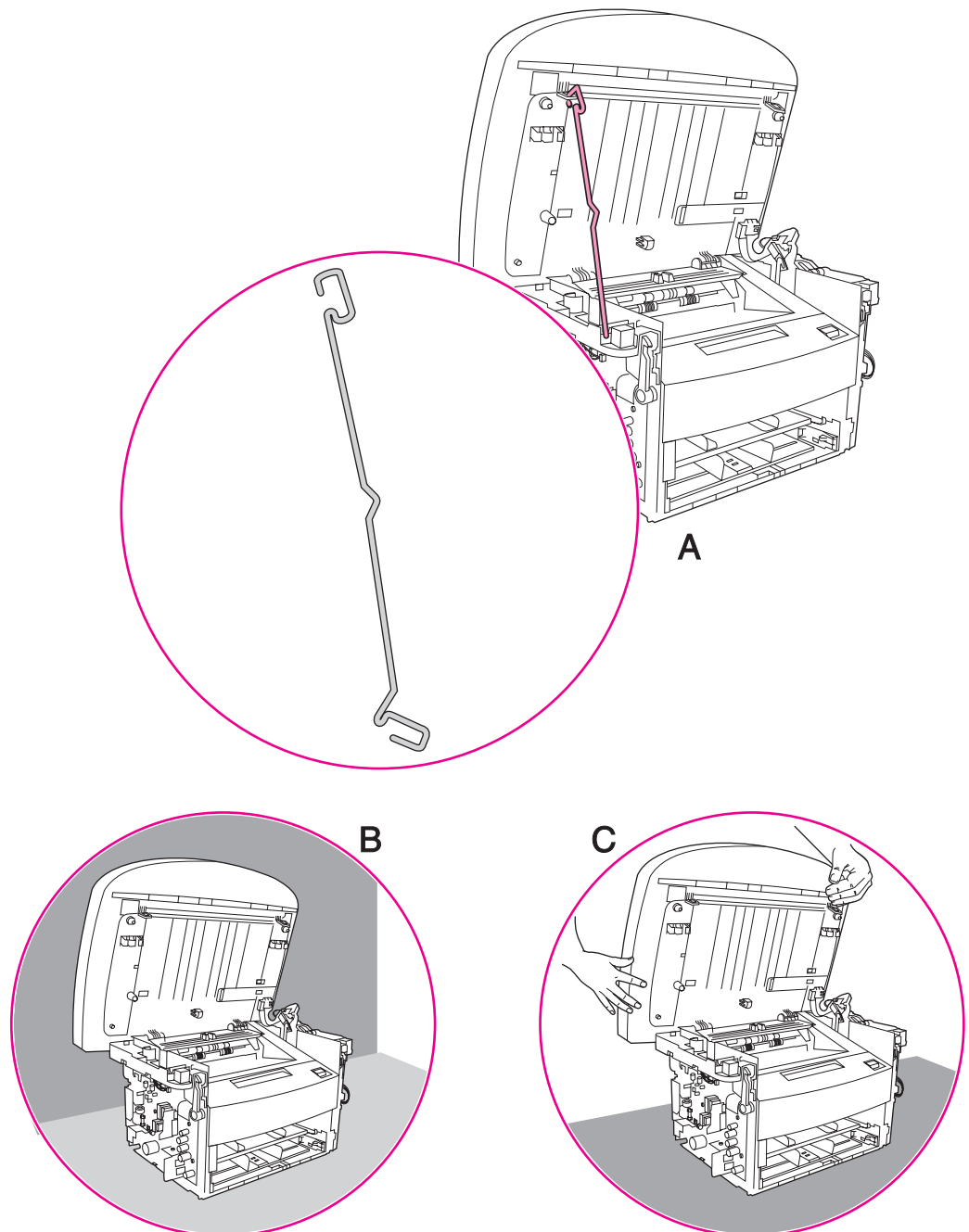
11. Use one of the following three separate methods to support the scanner assembly so that it does not fall off of the product base.

- **A** Use the HP scanner-support tool (part number: 5185-7441).

**Note**

Remove the left-side link before using the support tool.

- **B** Rest the scanner assembly against a wall.
- **C** Rest the scanner assembly against your chest

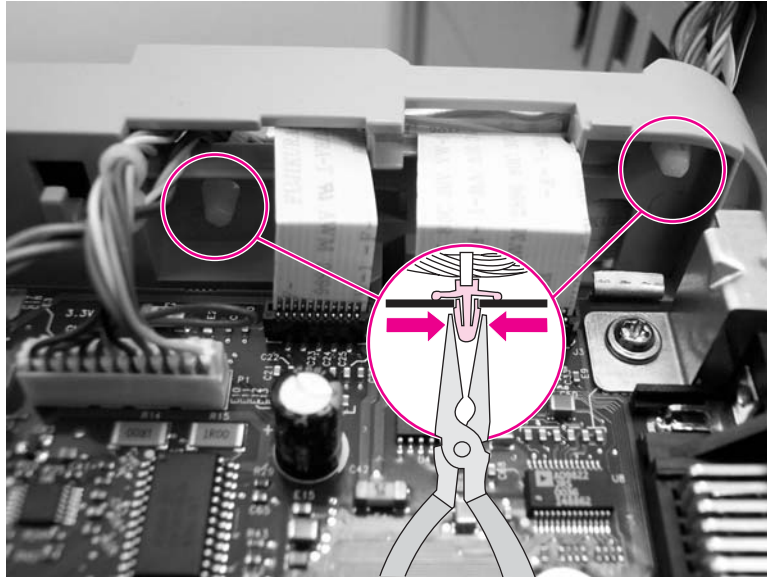


**Figure 5-84.** Remove the scanner assembly (10 of 13)

12. Use needle nose pliers to squeeze the two plastic wire-harness retainers and push them up into the scanner support frame.

**WARNING!**

**Do not** clip wire retainers. The wire-harnesses might be damaged if the retainers are clipped instead of removed.

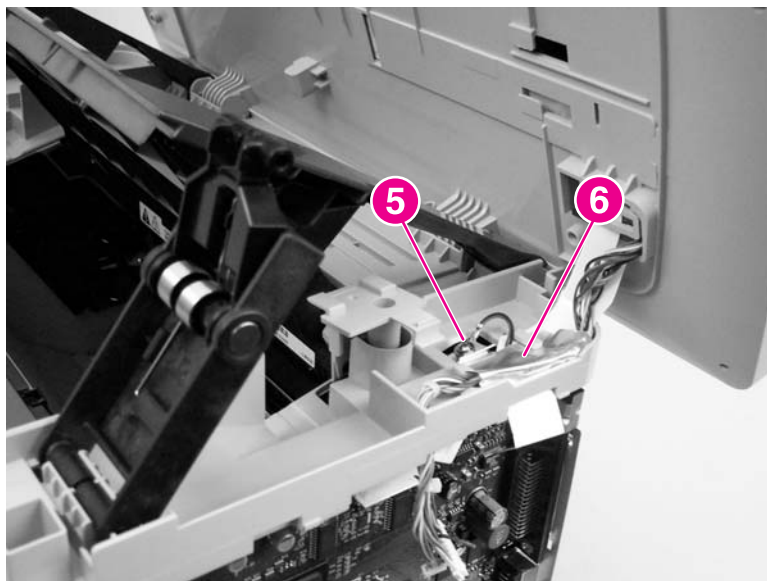


**Figure 5-85.** Remove the scanner assembly (11 of 13)

13. Remove one screw (callout 5). Carefully remove the grounding shield (callout 6) from the wire loom. Feed the two FFCs and the wire-harness through the hole in the chassis, and remove them from the wire loom.

**Reinstallation tip**

Take note of how the FFCs and wire-harnesses are routed through and attached to the scanner support frame.



**Figure 5-86.** Remove the scanner assembly (12 of 13)

14. Rotate the scanner assembly toward the rear of the product until the rear hinges clear the chassis hinge pins. Lift the scanner assembly off of the product base.

---

**CAUTION**

---

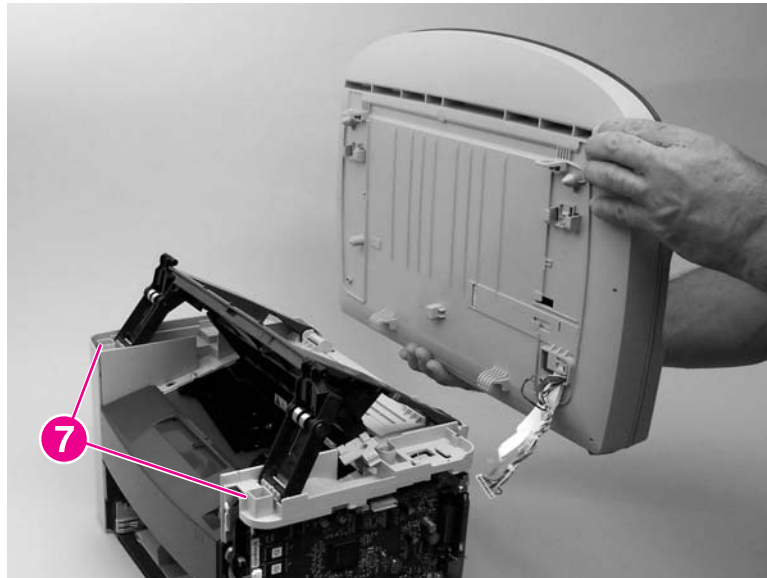
Make sure that the ADF cover and flatbed lid are supported so they do not swing open when the scanner assembly is removed.

---

**Note**

---

Do not lose the two scanner cushions located in the scanner support frame (callout 7).



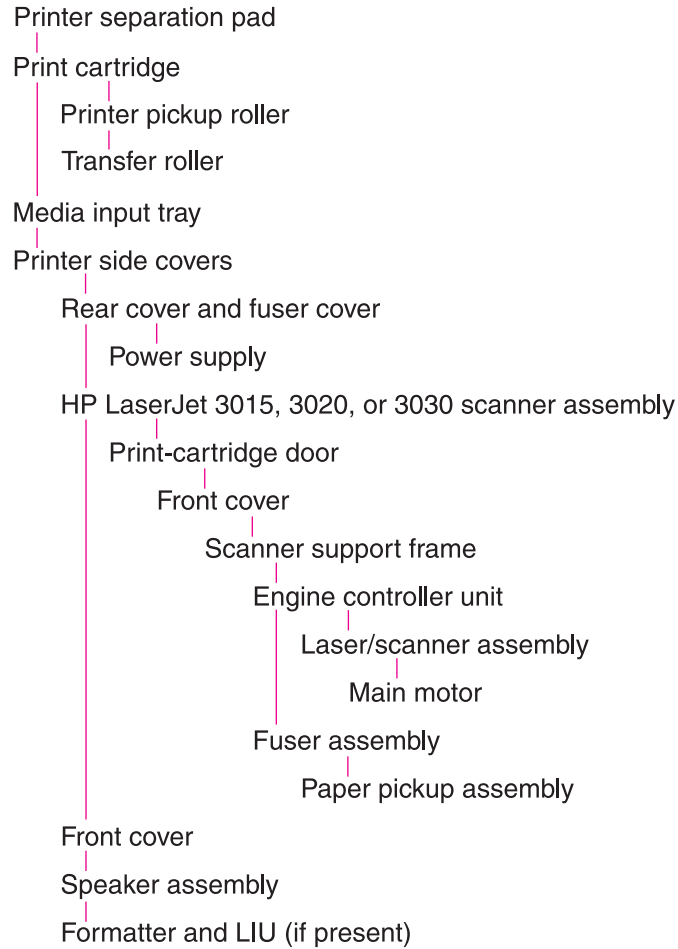
**Figure 5-87.** Remove the scanner assembly (13 of 13)

## Printer (product base)

This section documents removal and replacement instructions for components that are common to the HP LaserJet 3015, 3020, and 3030 products.

### Note

For clarity, the printer is shown without the scanner assembly in place. Removing the scanner assembly is not necessary to perform some of the procedures in this section.



Note: the front cover is listed twice.

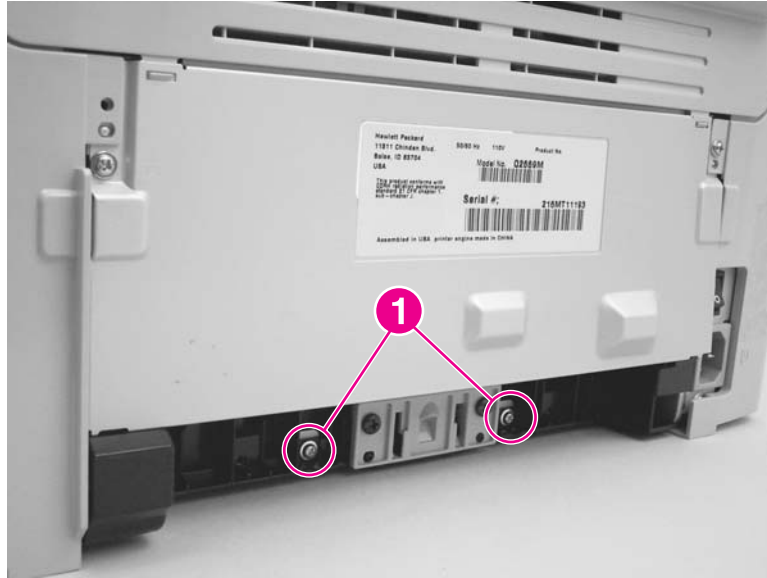
**Figure 5-88.**

**Parts removal order for the printer (product base, all models)**



## Printer separation pad

1. At the back of the product, remove two screws (callout 1).



**Figure 5-89.** Remove the printer separation pad (1 of 2)

2. Remove the printer separation pad and frame.



**Figure 5-90.** Remove the printer separation pad (2 of 2)

## Print cartridge

### CAUTION

To prevent damage, do not expose the print cartridge to direct or bright light. Cover it with a piece of paper.



1. Push the print-cartridge-door button to release the print-cartridge door.



**Figure 5-91.** Remove the print cartridge (1 of 2)

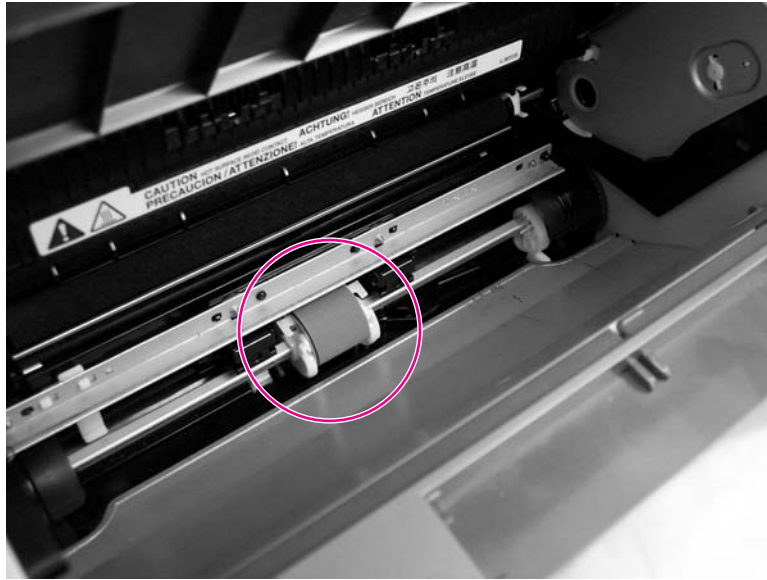
2. Pull the print cartridge up and out of the product.



**Figure 5-92.** Remove the print cartridge (2 of 2)

## Printer pickup roller

1. Remove the print cartridge and locate the printer pickup roller. See [Print cartridge](#).



**Figure 5-93.** Remove the printer pickup roller (1 of 5)

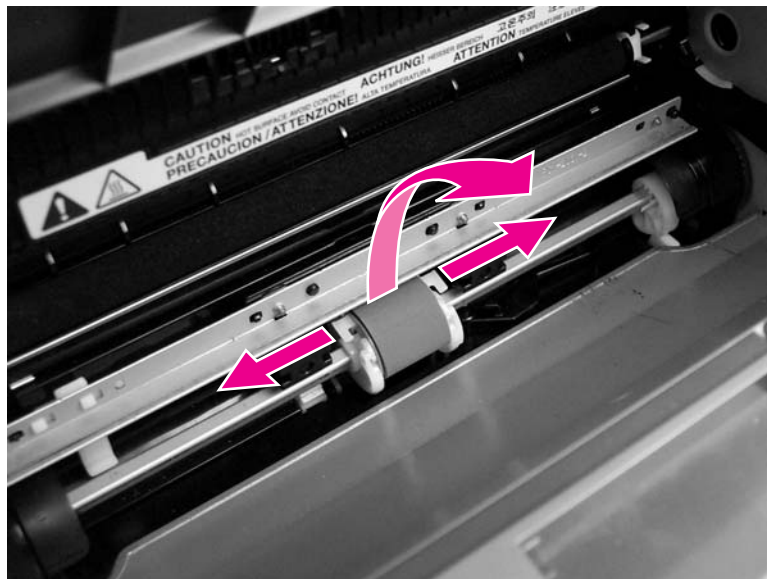
2. Gently release the small, white tabs on each side of the pickup roller by pushing them away from the roller, and then rotate the roller away from the mounting frame.

---

### CAUTION

Do not touch the black-sponge transfer roller inside the product. Touching the transfer roller can damage the product.

Use gentle pressure to release the small white tabs to avoid breaking them.



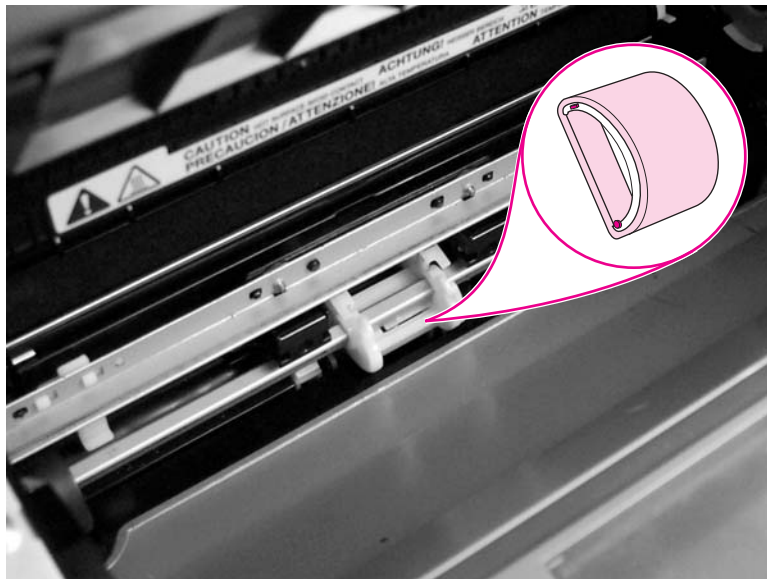
**Figure 5-94.** Remove the printer pickup roller (2 of 5)

3. Gently pull the roller up and out of the product.



**Figure 5-95.** Remove the printer pickup roller (3 of 5)

4. Circular and rectangular pegs on each side of the pickup roller fit into corresponding slots on the pickup-roller mounting frame to prevent the roller from being incorrectly installed. Position the replacement pickup roller in the slots on the pickup-roller frame.



**Figure 5-96.** Remove the printer pickup roller (4 of 5)

5. Rotate the top of the pickup roller into position until the white tabs on each side of the roller snap into place.



**Figure 5-97.** Remove the printer pickup roller (5 of 5)

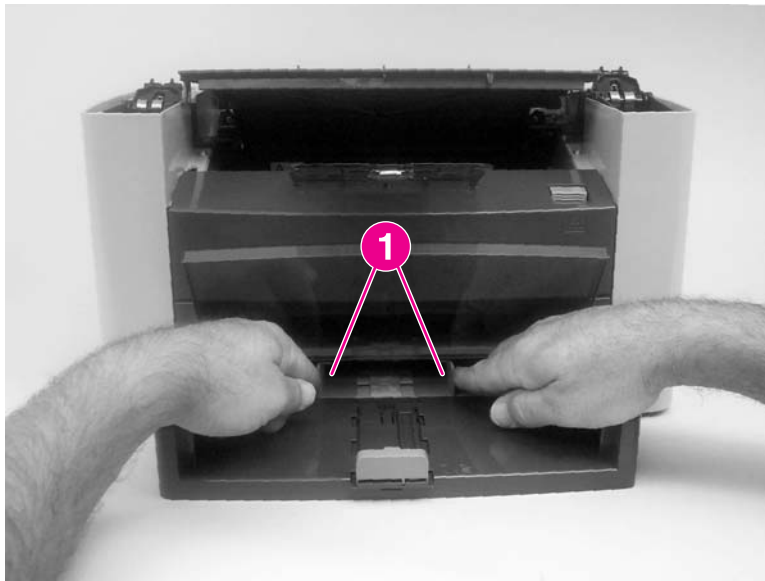
## Media input tray

1. Open the media input tray lid.



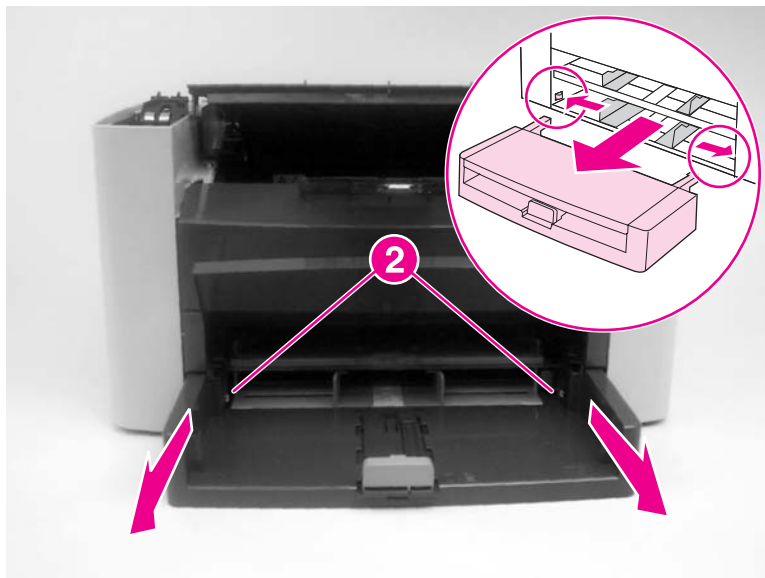
**Figure 5-98.** Remove the media input tray (1 of 3)

- Slide the adjustable media guides (callout 1) to the center of the tray.



**Figure 5-99.** Remove the media input tray (2 of 3)

- Depress the pickup-tray locking tabs (callout 2) to release the media input tray, and then pull it out and away from the product.



**Figure 5-100.** Remove the media input tray (3 of 3)

## Transfer roller

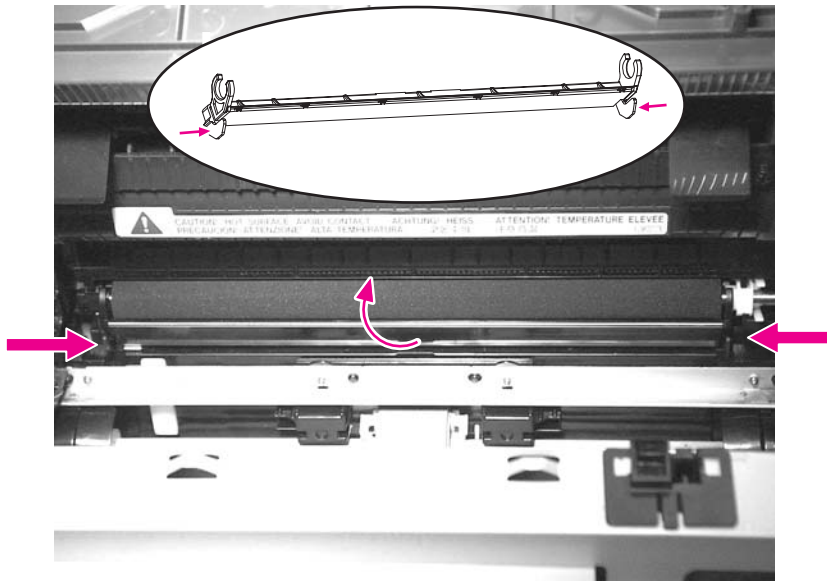
### CAUTION

Do not touch the black-sponge portion of the transfer roller. Skin oils deposited on the transfer roller might cause print-quality problems.

Be very careful not to break the paper guide that is removed during replacement of the transfer roller. Because the paper guide is not a FRU, the entire printer will have to be replaced.

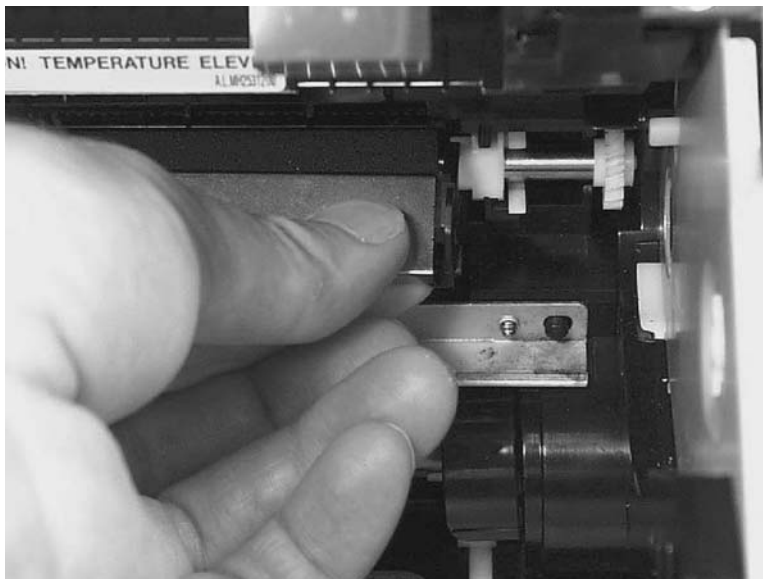
- Open the print-cartridge door and remove the print cartridge.

2. Release the two locking tabs on the paper guide and rotate the guide up.



**Figure 5-101.** Remove the transfer roller (1 of 3)

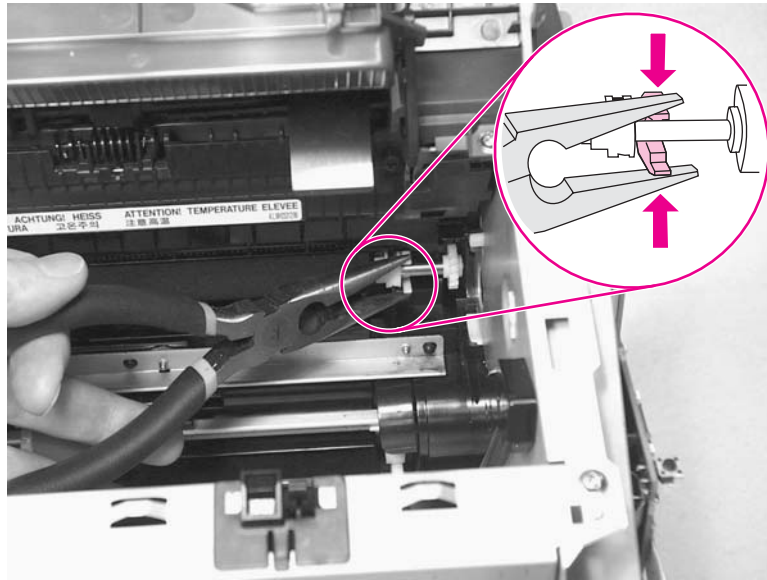
3. The clamps on the paper guide fit over the bearings on each end of the transfer roller. Do not touch the black-sponge portion of the transfer roller. Grasp the right end of the paper guide and pull the clamp off the bearing on the right side of the transfer roller. Then slide the clamp slightly to the right, and the left clamp will slide off the left bearing.



**Figure 5-102.** Remove the transfer roller (2 of 3)



4. Squeeze the two small tabs on the transfer roller.



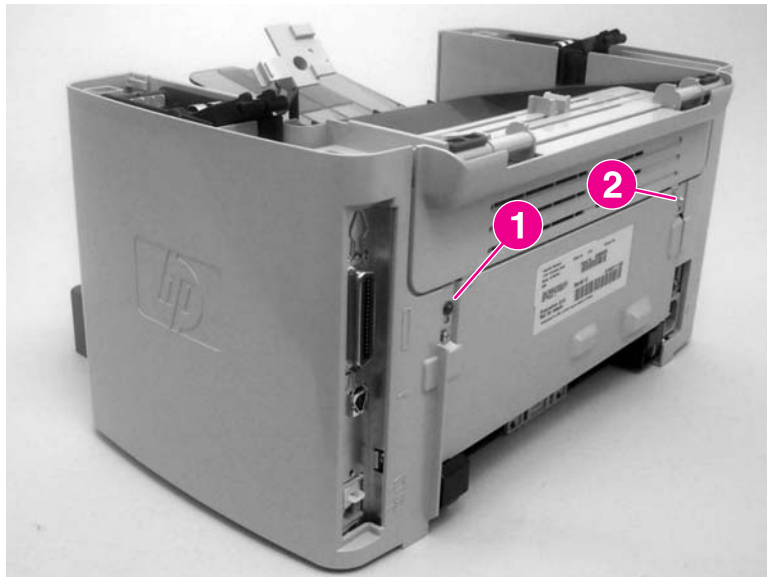
**Figure 5-103.** Remove the transfer roller (3 of 3)

## Printer side covers

### Note

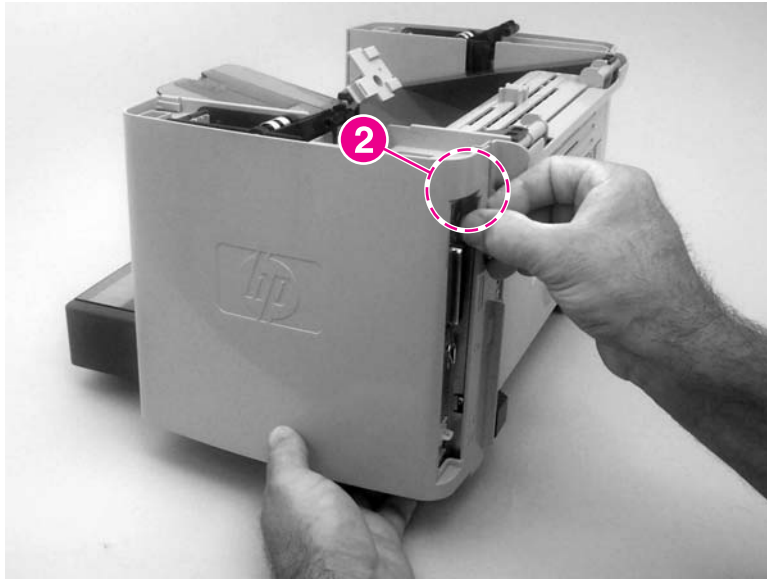
The procedure for removing the right-side and left-side covers is identical, with the exception of the location of the screw that fastens the cover to the product. The right-side cover is shown in the following procedure.

1. Remove one screw (callout 1; the right-side cover uses a black screw). Callout 2 is on the left-side cover.



**Figure 5-104.** Remove the printer side covers (1 of 3)

2. Release the locking tabs on the upper-back (callout 2).



**Figure 5-105.** Remove the printer side covers (2 of 3)

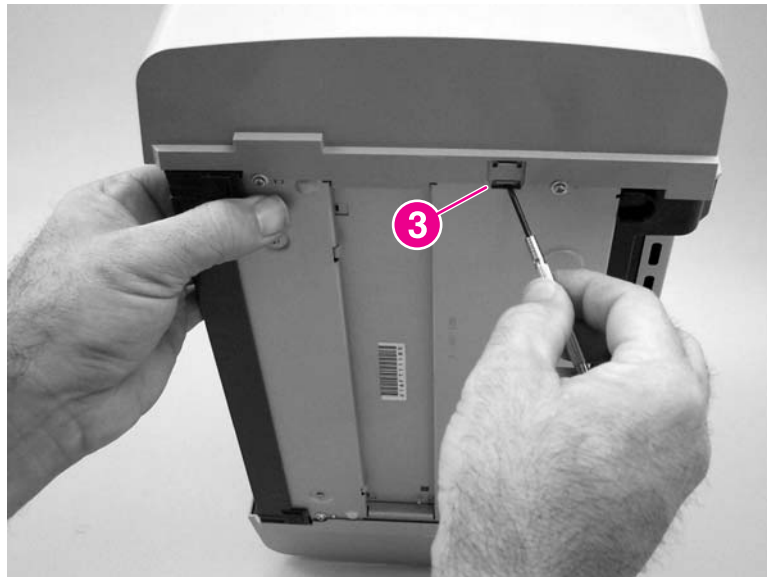
3. Release the bottom tab (callout 3).

---

**CAUTION**

---

When removing the left-side cover hang the product off of the table to gain access to the bottom tab. This prevents the I/O shield from being damaged if the right-side cover is off and the product is tilted too far up.



**Figure 5-106.** Remove the printer side covers (2 of 3)



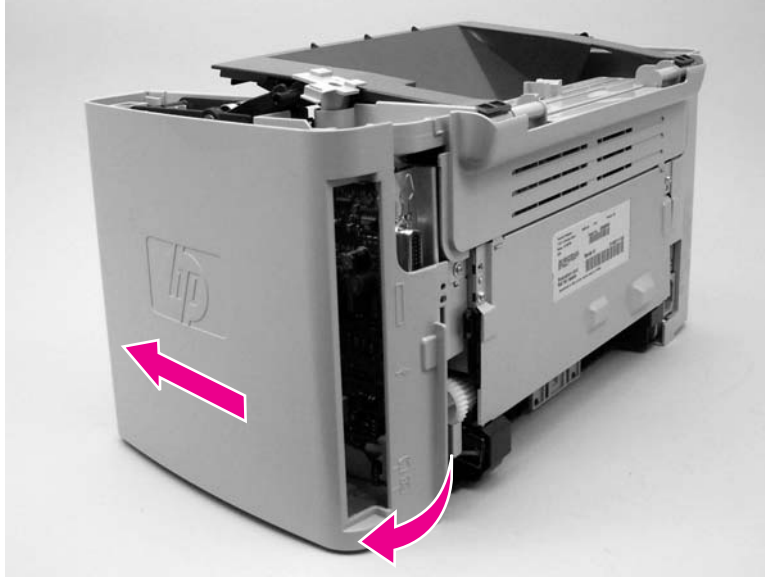
4. Slightly rotate the back-side of the right cover away from the product, and then slide it toward the front of the product to release it.

---

**CAUTION**

---

Make sure that the parallel connector bails are in the closed position. If they are in the open position, they might spring off when the cover is removed and be lost.



**Figure 5-107.** Remove the printer side covers (3 of 3)

## Print-cartridge door

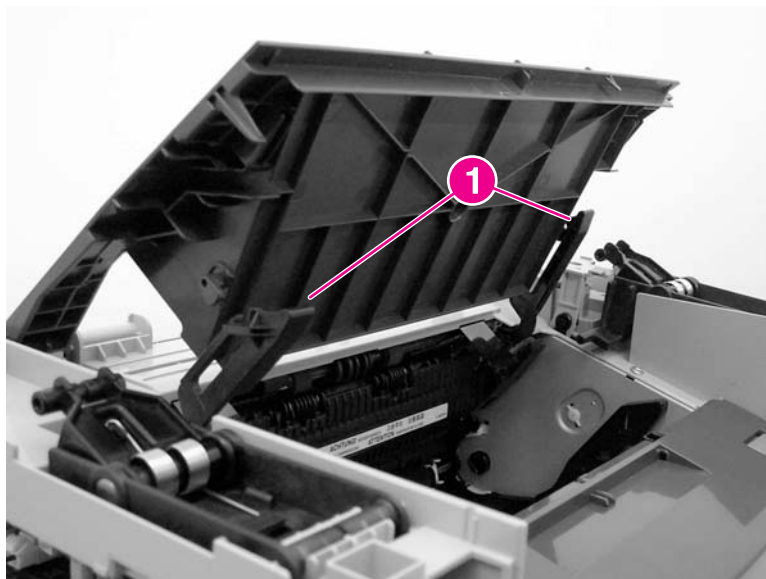
1. Remove the scanner assembly. For the HP LaserJet 3015, see [Scanner assembly](#). For the LaserJet 3020 and 3030, see [Scanner assembly](#).
2. Fully open the print-cartridge door and gently pull downward on both print-cartridge swing arms (callout 1) to release them (the left arm is shown disengaged).

---

**CAUTION**

---

Be careful when releasing the swing arms. They can easily break.



**Figure 5-108.** Remove the print-cartridge door (1 of 2)

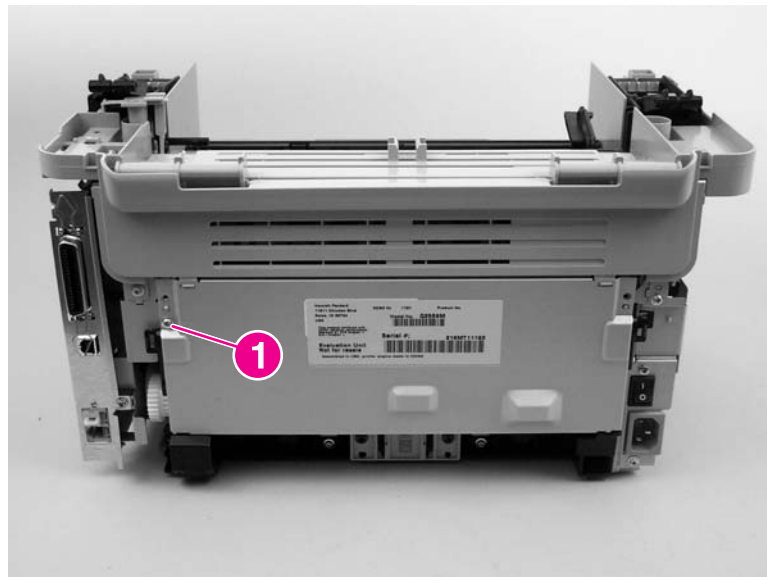
3. Rotate the door toward the back of the printer and then lift it up and off of the printer.



**Figure 5-109.** Remove the print-cartridge door (2 of 2)

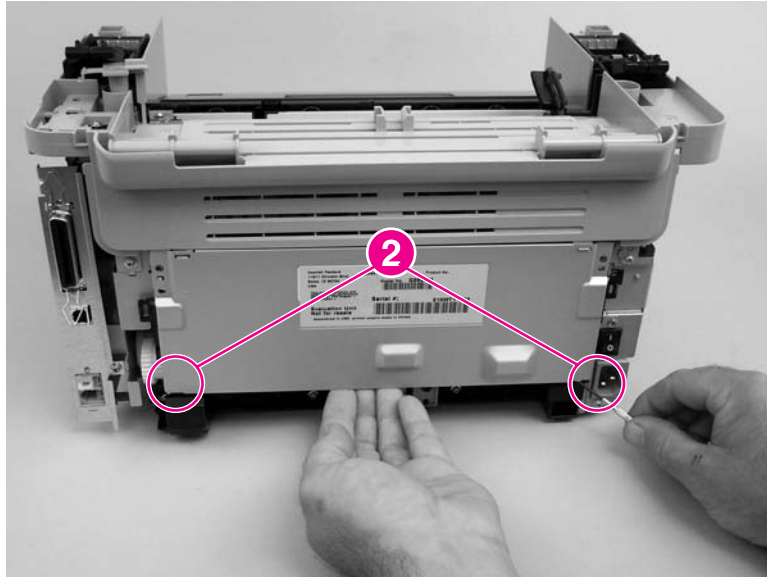
## Rear cover and fuser cover

1. Remove the right-side and left-side covers. See [Printer side covers](#)
2. Remove one screw (callout 1).



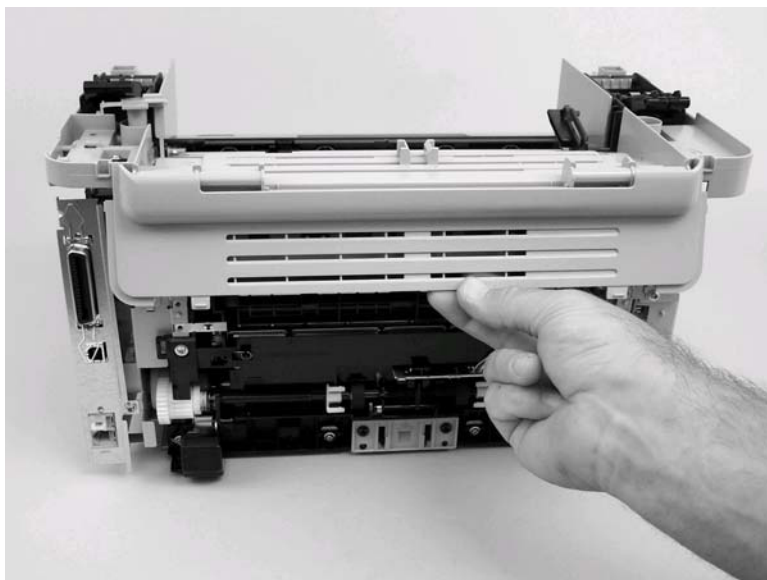
**Figure 5-110.** Remove the rear cover and fuser cover (1 of 3)

3. Release the two rear-cover locking tabs (callout 2). Rotate the bottom of the rear cover up and away from the printer, and remove it.



**Figure 5-111.** Remove the rear cover and fuser cover (2 of 3)

4. Rotate the bottom of the fuser cover away from the printer, and remove the fuser cover.

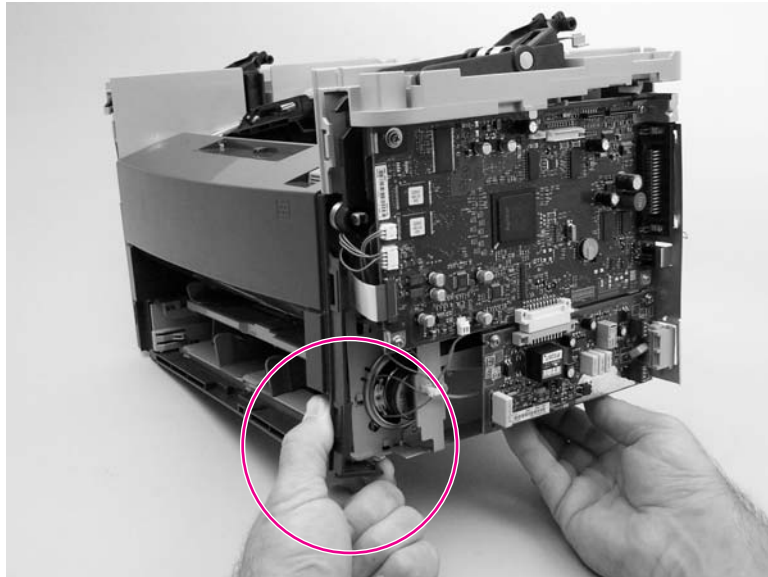


**Figure 5-112.** Remove the rear cover and fuser cover (3 of 3)

## Front cover

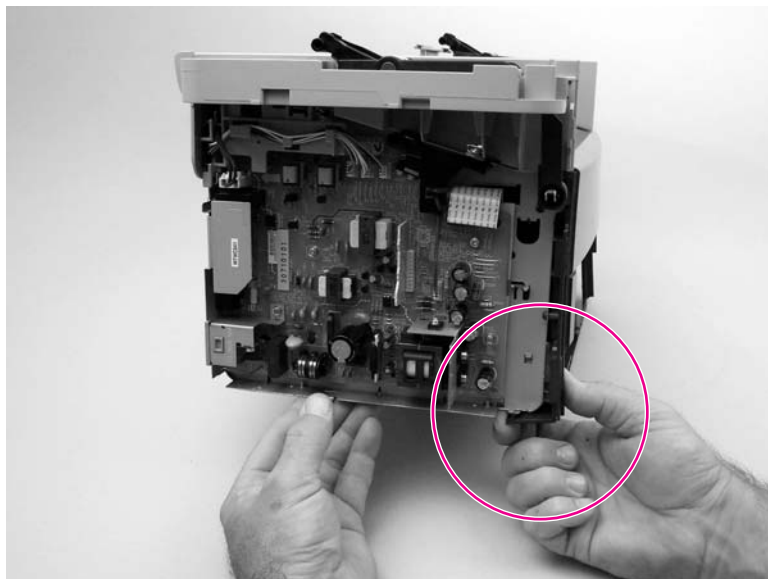
1. Remove the right-side and left-side covers. See [Printer side covers](#).

2. Release the lower right-side front-cover locking tab and slightly pry the lower-right corner of the front cover away from the printer.



**Figure 5-113.** Remove the front cover (1 of 3)

3. Release the lower left-side front-cover locking tab ( located near the corner of the power supply) and slightly pry the lower-left corner of the front cover away from the printer.



**Figure 5-114.** Remove the front cover (2 of 3)

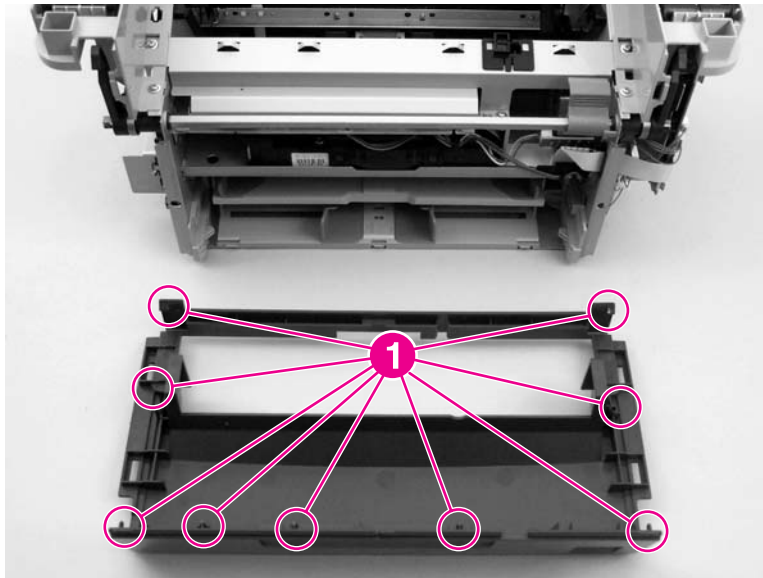
4. Pry up and pull out on the front cover to release it from the printer. Remove the front cover.



**Figure 5-115.** Remove the front cover (3 of 3)

### Reinstallation tip

Note the location of the front-cover tabs (callout 1). Make sure that all of the front cover tabs are fully seated when the cover is installed.

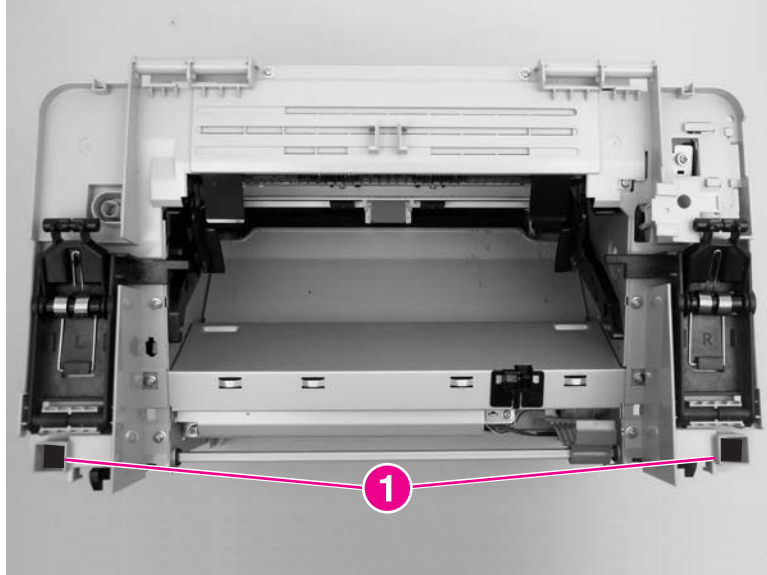


**Figure 5-116.** Front-cover locking tabs

### Installing the scanner cushions

1. Open the print-cartridge door.

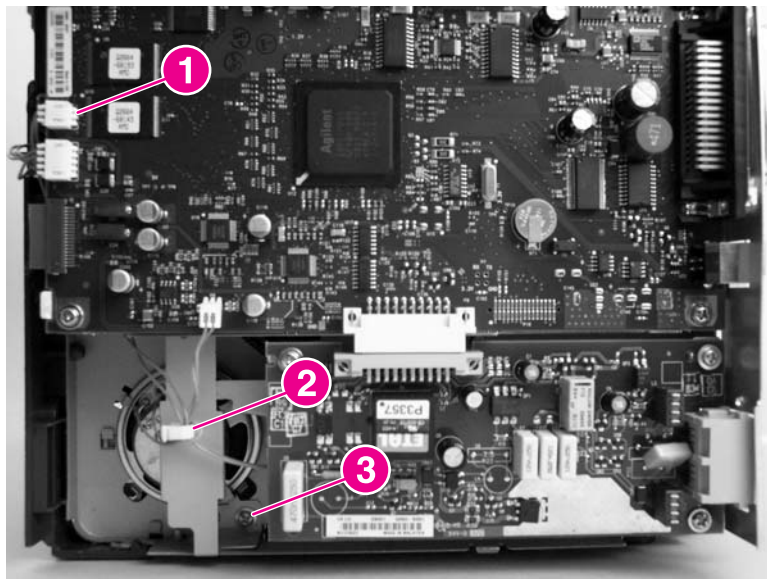
2. Place a scanner cushion in the wells on the scanner support frame (callout 1). Use the eraser end of a pencil or use an ink pen with the cap on to seat each cushion in its well.



**Figure 5-117.** Installing the scanner cushions

## Speaker assembly

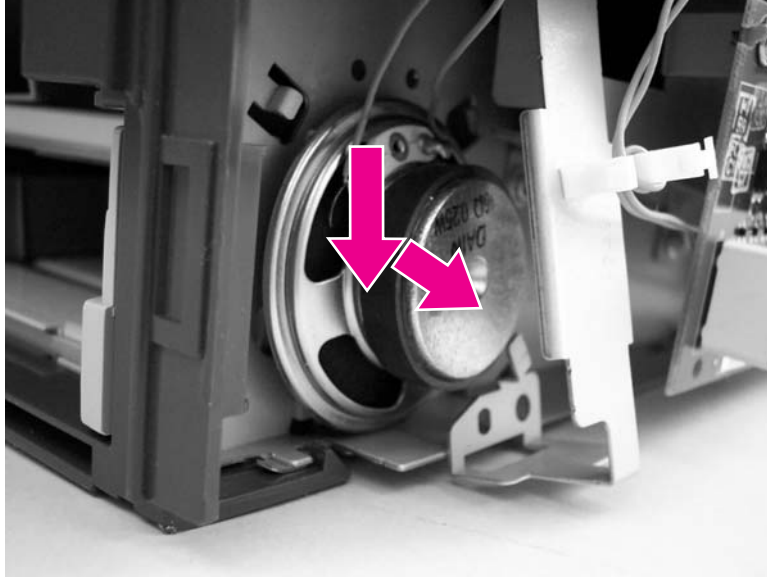
1. Remove the right-side printer cover. See [Printer side covers](#)
2. Disconnect one wire-harness connector (callout 1), unclip one wire retainer (callout 2), and then remove 1 screw (callout 3).



**Figure 5-118.** Remove the speaker assembly (1 of 2)



3. Carefully pry the sheet-metal brace away from the printer chassis. Slide the speaker down and slightly to the right to release it from the retaining clips on the printer chassis.



**Figure 5-119.** Remove the speaker assembly (2 of 2)

### Reinstallation tip

When installing a replacement speaker, be careful to not tear the speaker cone on any exposed sharp sheet-metal edges.

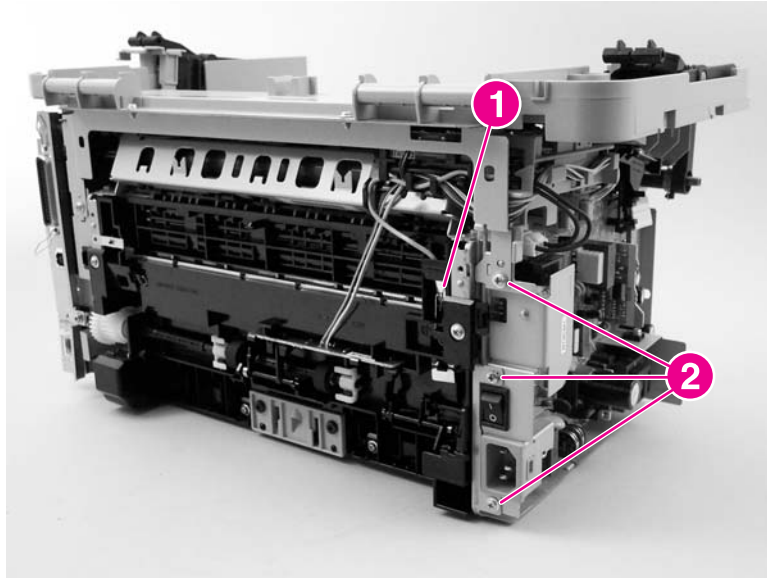
### Power supply

1. Remove the rear cover and fuser cover. See [Rear cover and fuser cover](#).

2. Disconnect one spade connector (callout 1) and remove three screws (callout 2).

### Reinstallation tip

The center screw in callout 2 is a ground screw and is a different type than the others. When reinstalling the power supply, make sure that this screw is used in the center hole.

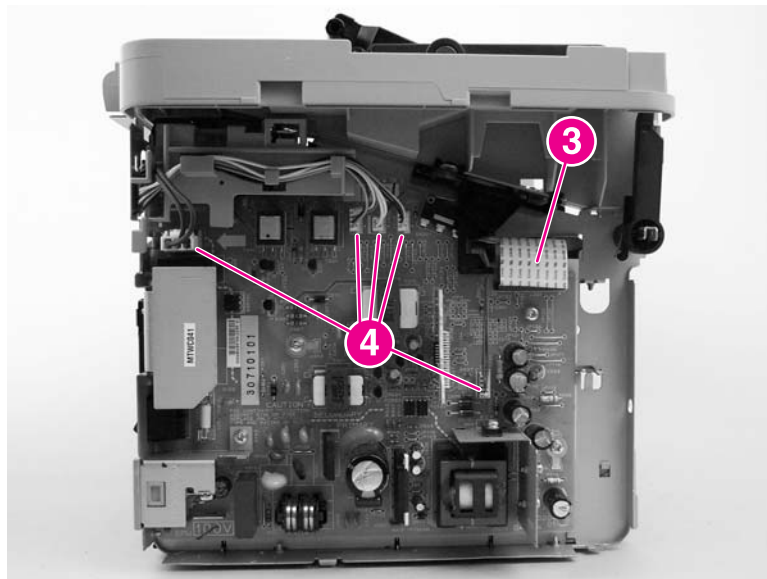


**Figure 5-120.** Remove the power supply (1 of 3)

3. Disconnect one FFC (callout 3) and five wire-harness connectors (callout 4) and remove them from the wire loom.

### CAUTION

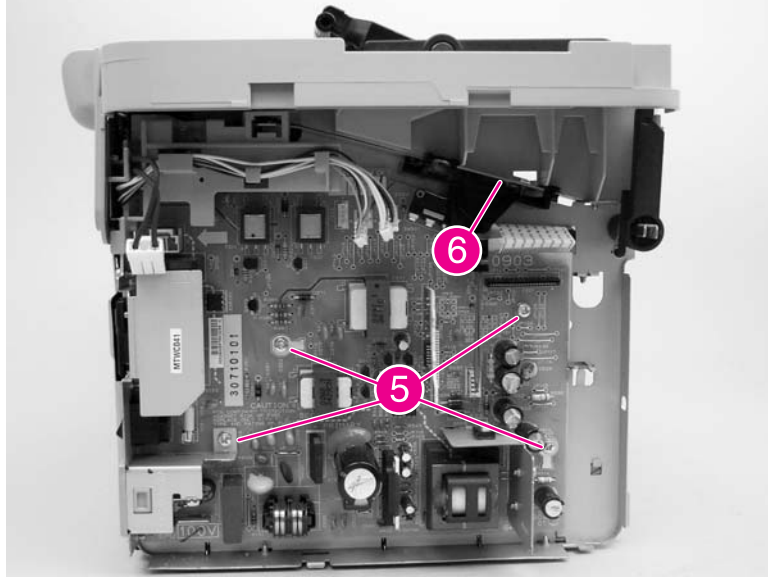
Do not bend or fold the FFCs during the removal or reinstallation process.



**Figure 5-121.** Remove the power supply (2 of 3)



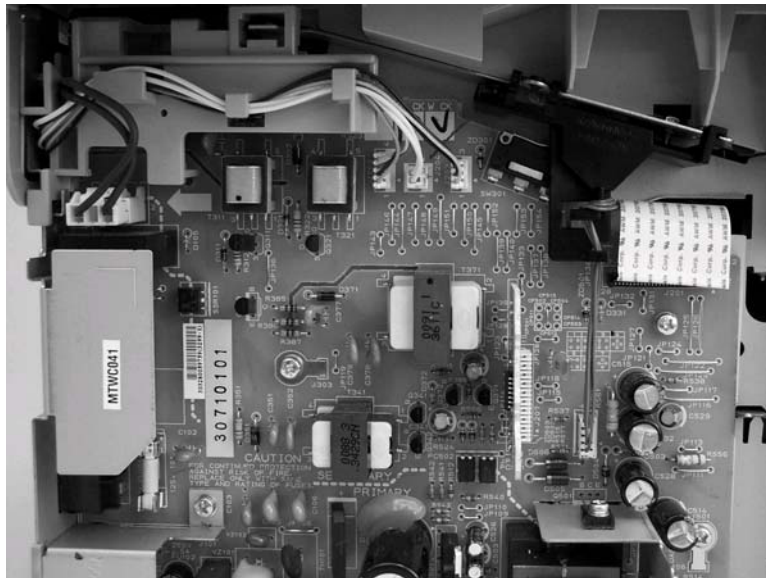
- Remove four screws (callout 5) and remove the wire-harness from the wire loom (callout 6) and unclip the wire loom from the chassis (remove the wire-harness from this wire loom). Remove the power supply



**Figure 5-122.** Remove the power supply (3 of 3)

### Reinstallation tip

When reinstalling the power supply, make sure that the wire-harnesses are routed correctly.



**Figure 5-123.** Correct routing of the power-supply wire-harnesses

## Formatter and line interface unit (LIU)

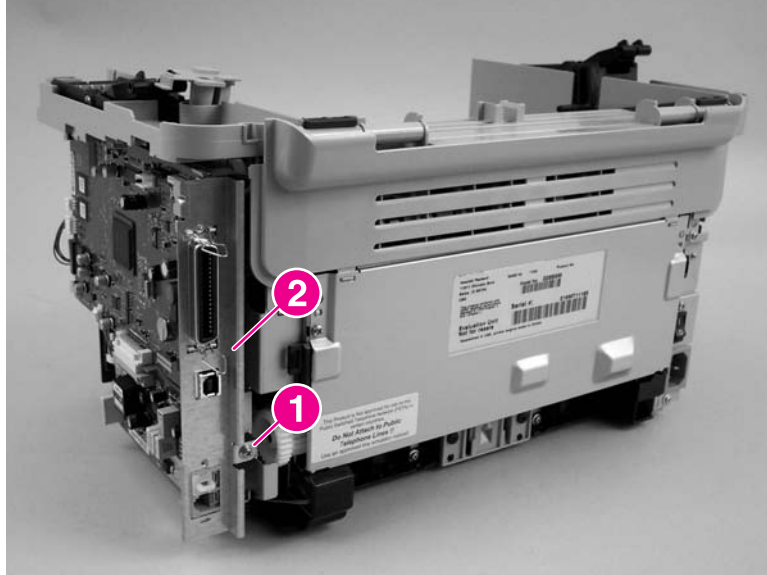
### CAUTION

The formatter and LIU are ESD-sensitive devices.

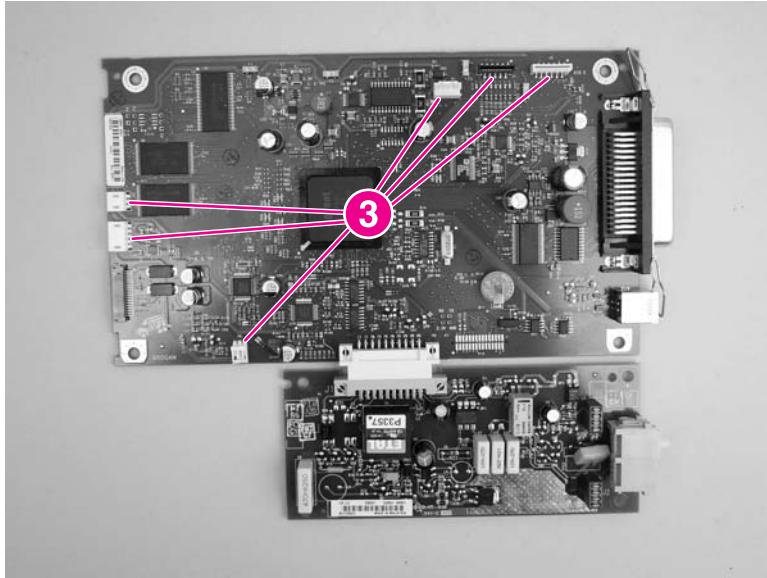
### Note

The HP LaserJet 3020 does not have a line interface unit (LIU) because it does not have fax capabilities.

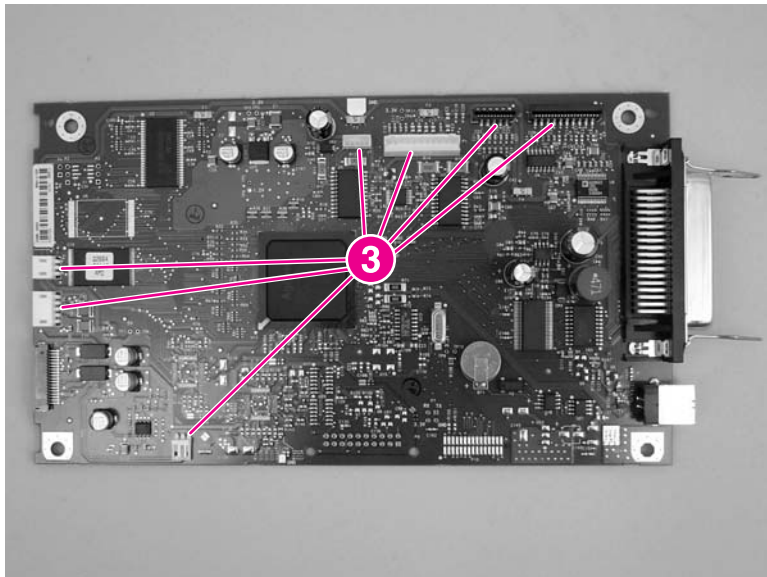
1. Remove the right cover. See [Printer side covers](#).
2. Remove one screw (callout 1) and the I/O shield (callout 2).



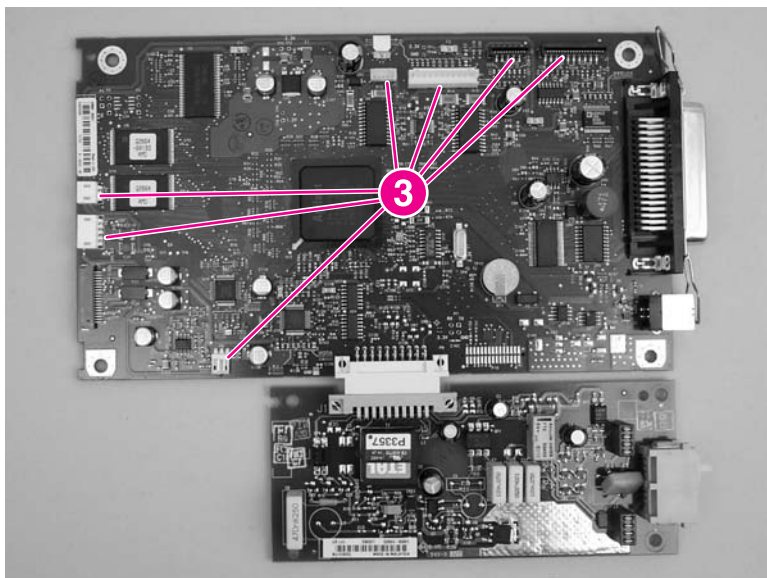
3. Disconnect all of the connectors (callout 3) on the formatter.



**Figure 5-124.** HP LaserJet 3015 formatter and LIU



**Figure 5-125.** HP LaserJet 3020 formatter without LIU



**Figure 5-126.** HP LaserJet 3030 formatter and LIU  
ENWW

4. Remove 4 screws from the formatter PCA (callout 2). For the LJ 3015 and 3030, remove three screws (callout 3) from the LIU. Remove the formatter and any LIU PCAs.

---

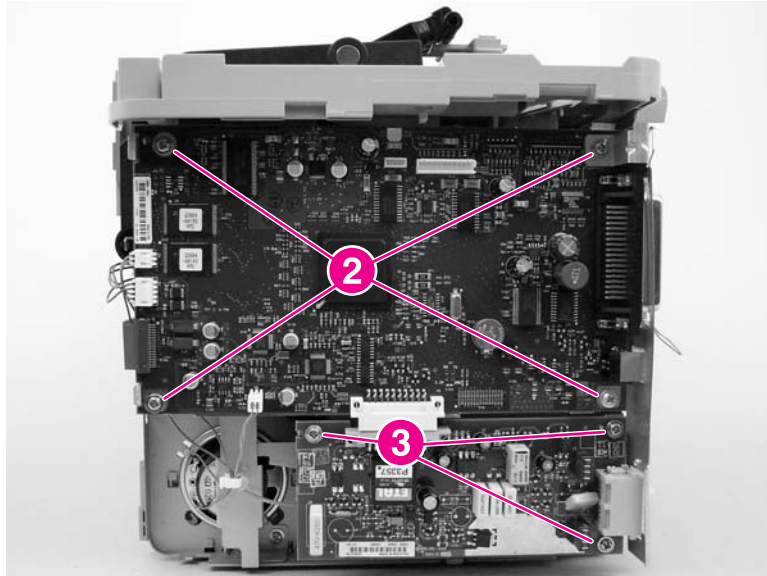
**Note**

---

If the LIU on the LJ 3015 or 3030 product is being replaced, separate the formatter from the LIU by gently pulling them apart.

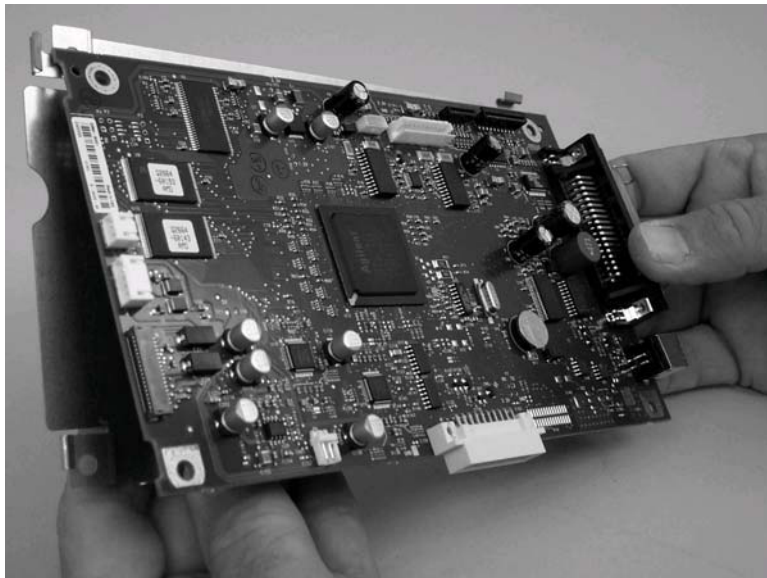
**Reinstallation tip**

When reinstalling the formatter, make sure that the upper mounting leg on the I/O plate (the cover that surrounds the parallel and USB port) is fastened to the formatter when the top-right formatter screw in callout 2 is installed



**Figure 5-127.** Remove the formatter (1 of 2) (and LIU installed)

5. Gently separate the formatter from the sheet-metal shield. Mount the replacement formatter to this shield.



**Figure 5-128.** Remove the formatter (2 of 2)

## Scanner support frame

1. Remove the following assemblies
  - Scanner assembly. For the HP LaserJet 3015, see [Scanner assembly](#). For the LaserJet 3020 and 3030, see [Scanner assembly](#).
  - Left cover. See [Printer side covers](#).
  - Rear cover and fuser cover. See [Rear cover and fuser cover](#).
  - Print cartridge door. See [Print-cartridge door](#).
  - Front cover. See [Front cover](#).
2. Remove six screws (callout 1).

---

**CAUTION**

---

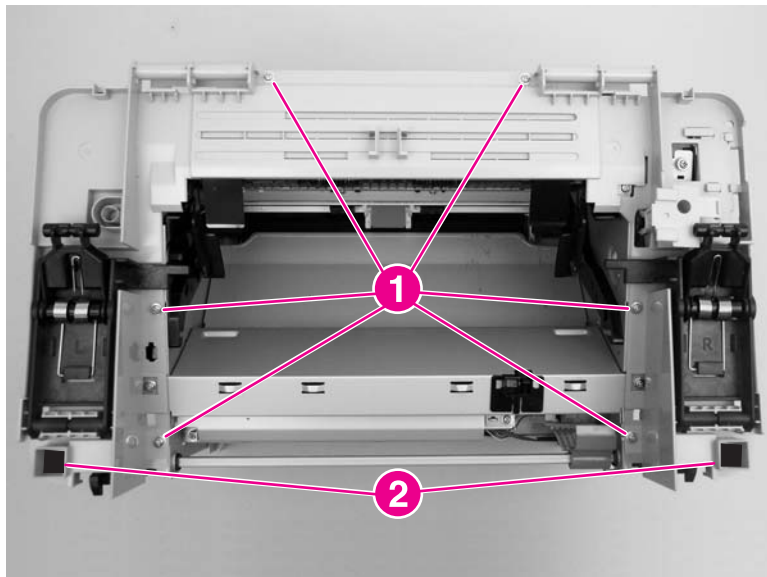
Be careful not to drop any screws into the printer.

---

**Note**

---

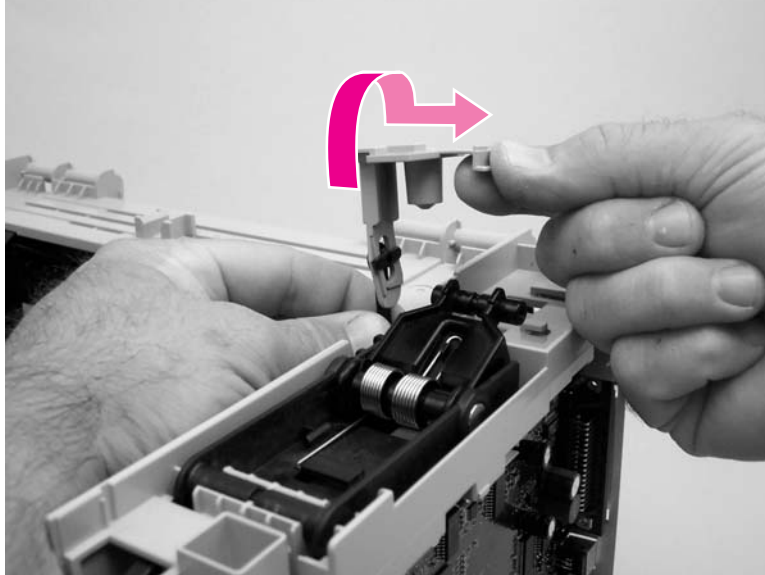
If the scanner support frame is turned over after it is removed, the two scanner cushions (callout 2) might fall out and be misplaced.



**Figure 5-129.** Remove the scanner support frame (1 of 3)

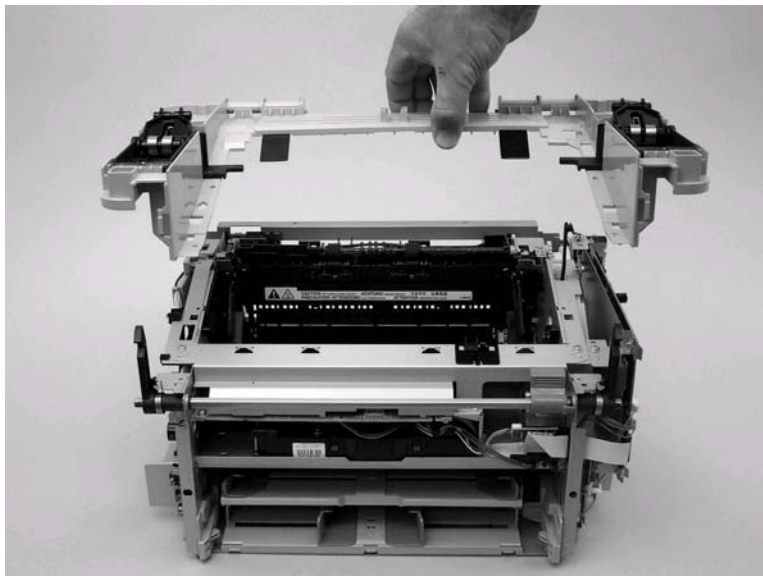


3. Rotate the gear-drive bracket until the retainer on the gear-drive arm aligns with the opening in the bracket, and remove the bracket.



**Figure 5-130.** Remove the scanner support frame (2 of 3)

4. Lift the scanner support frame up and off of the printer.



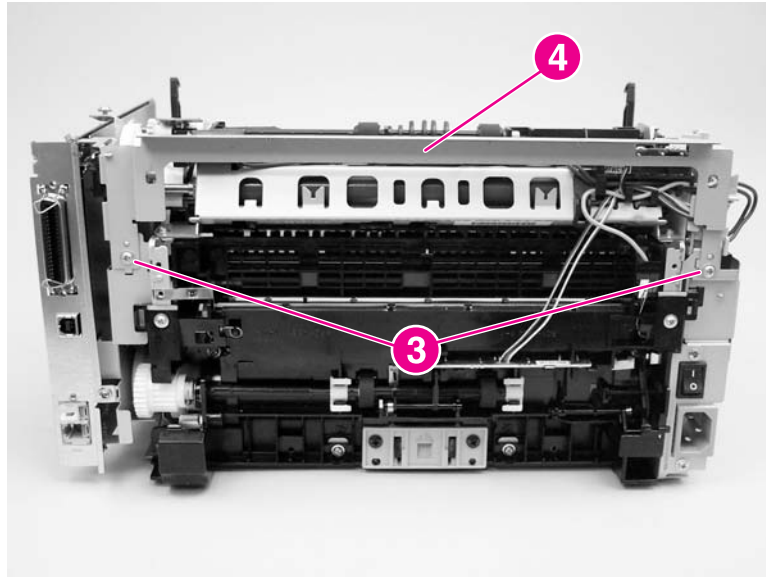
**Figure 5-131.** Remove the scanner support frame (3 of 3)

---

**Note**

---

If the scanner support frame is being removed to gain access to the fuser, remove two screws (callout 3) and the chassis reinforcement plate (callout 4)

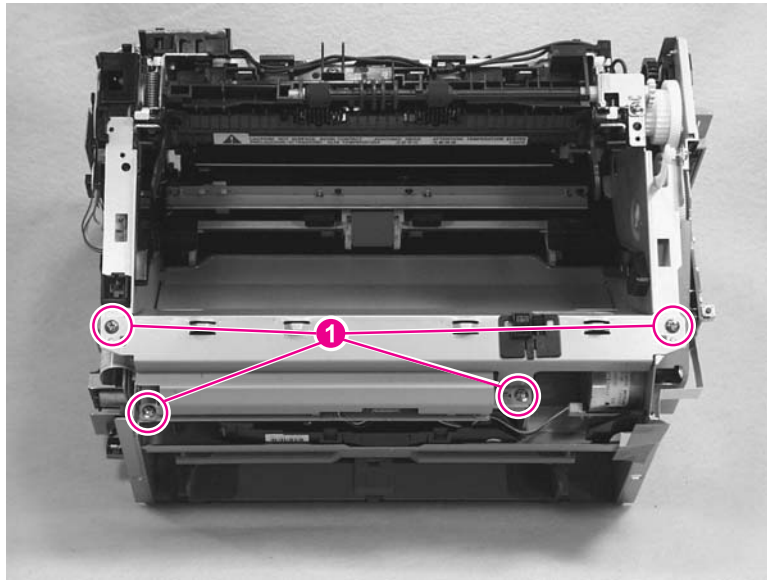


**Figure 5-132.** Remove the chassis reinforcement plate

## Engine controller unit

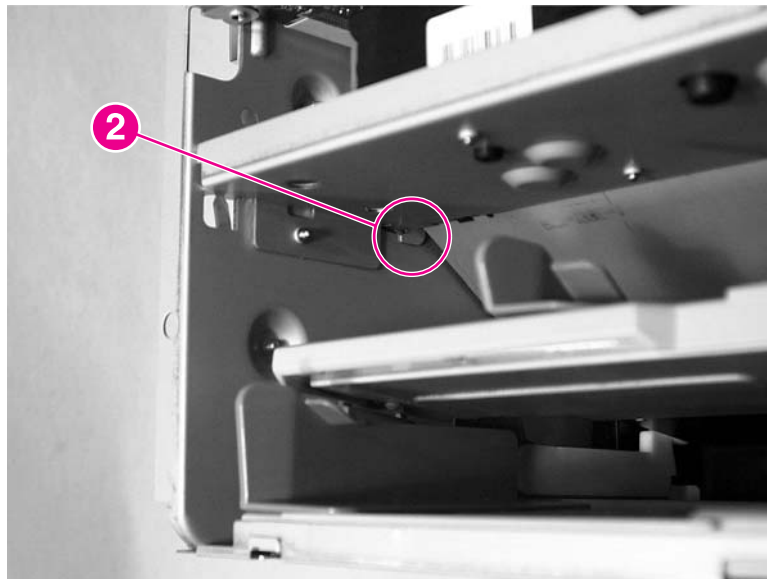
1. Remove the following assemblies.
  - Scanner assembly. For the HP LaserJet 3015, see [Scanner assembly](#). For the LaserJet 3020 and 3030, see [Scanner assembly](#).
  - Left cover. See [Printer side covers](#).
  - Rear cover and fuser cover. See [Rear cover and fuser cover](#).
  - Print cartridge door. See [Print-cartridge door](#).
  - Front cover. See [Front cover](#).
  - Scanner support frame. See [Scanner support frame](#).

2. Remove four screws (callout 1).



**Figure 5-133.** Remove the ECU (1 of 6)

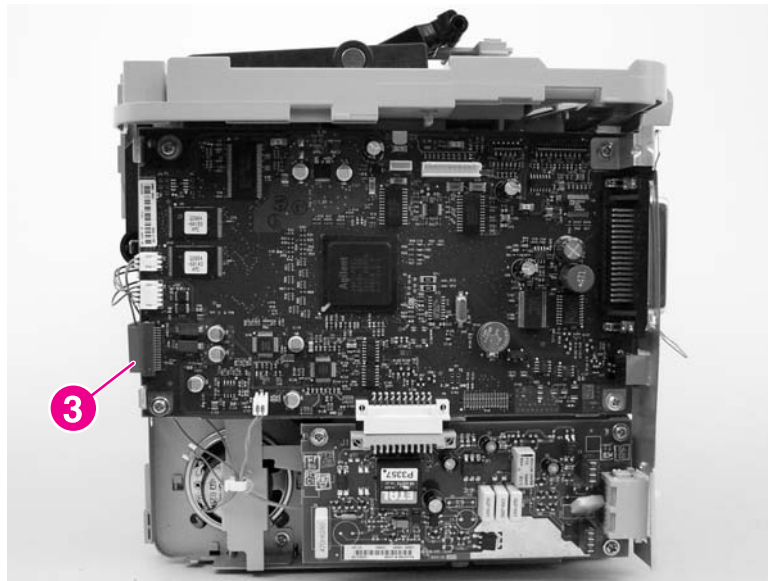
3. Use a long flat-blade screwdriver to disengage the engine control unit (ECU) shield retainer hooks (left hook shown; callout 2) inside the printer. Push the hooks into the printer to disengage them.



**Figure 5-134.** Remove the ECU (2 of 6)



4. Disconnect one FFC (callout 3) from the formatter.

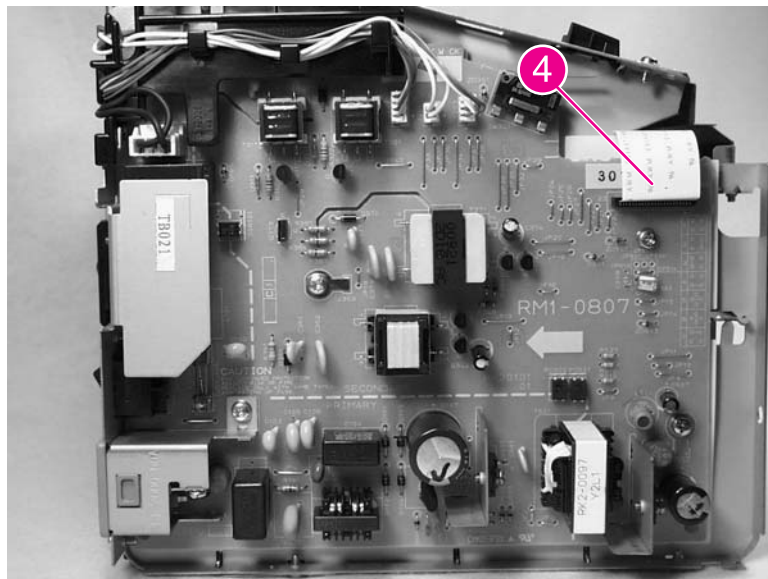


**Figure 5-135.** Remove the ECU (3 of 6)

5. Disconnect one FFC (callout 4) from the power supply.

**CAUTION**

Do not bend or fold the FFCs during the removal or reinstallation process.



**Figure 5-136.** Remove the ECU (4 of 6)

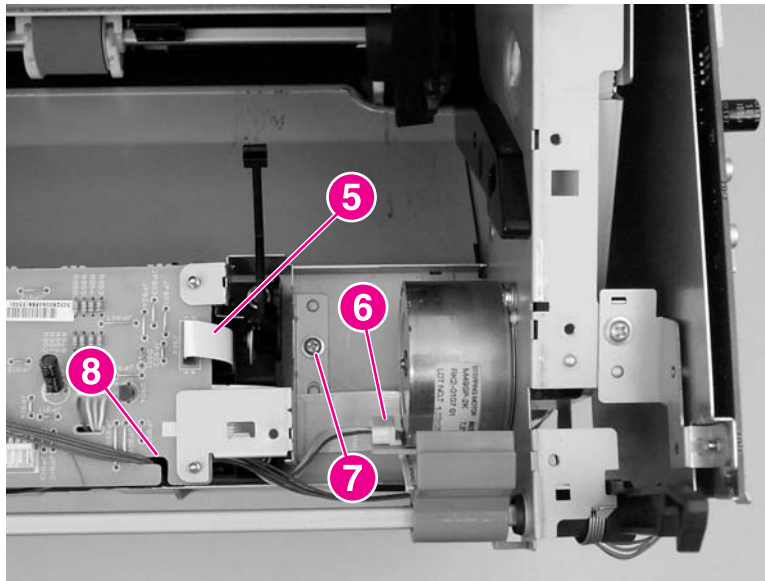
6. Disconnect one FFC (callout 5) from the ECU and the wire-harness connector to the main motor (callout 6). Remove one screw (callout 7). Release the wire-harness (callout 8) from the retainer slot on the ECU.

---

**Hint**

---

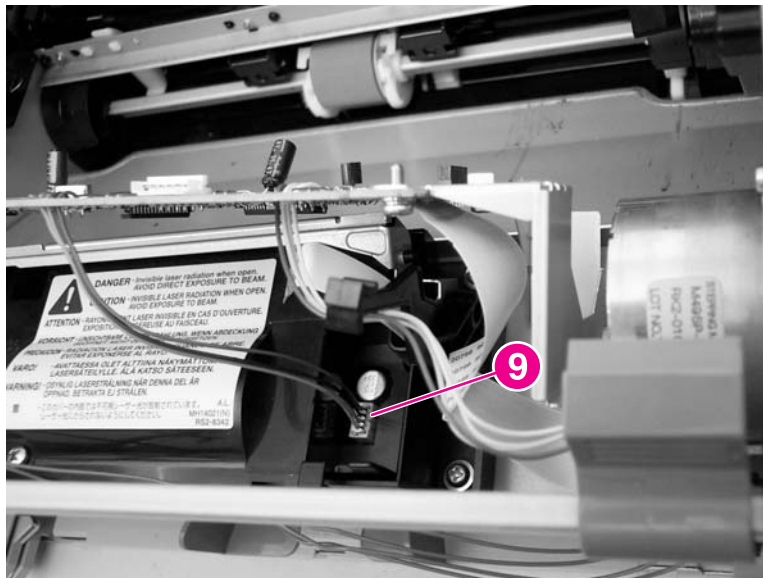
Unweave this wire-harness from additional wire looms to have enough slack to disengage it from the slot on the ECU.



**Figure 5-137.**

**Remove the ECU (5 of 6)**

7. Carefully remove the ECU from the printer. As it is removed, unweave the wire-harnesses and FFCs from the wire looms, and disconnect one wire-harness connector (callout 9) from the laser/scanner. Remove the ECU.

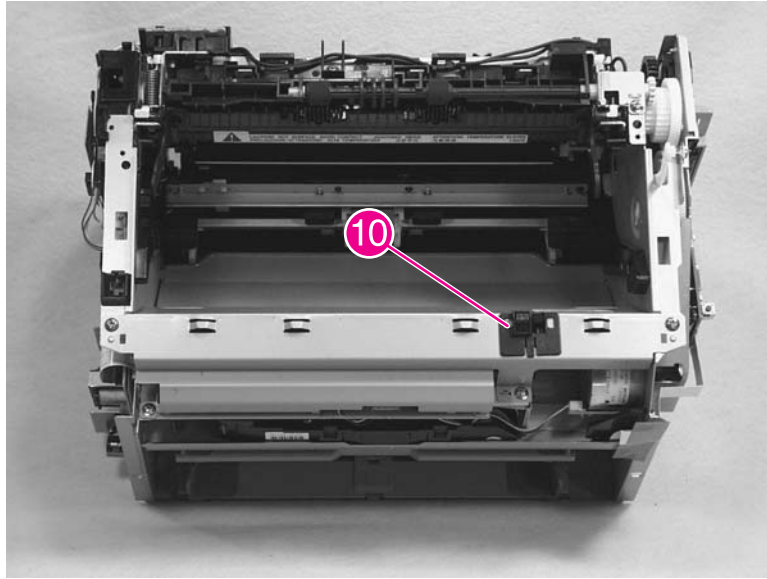


**Figure 5-138.**

**Remove the ECU (6 of 6)**

## Reinstallation tip

Make sure that the laser/scanner shutter arm fits into the black-plastic guide (callout 10) on the ECU shield when the shield is installed.

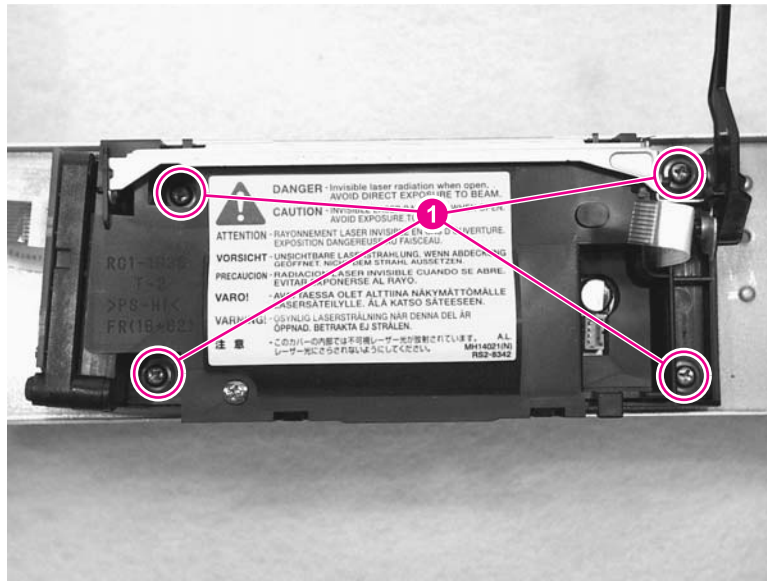


**Figure 5-139.** Laser/scanner assembly shutter arm

## Laser/scanner assembly

1. Remove the following assemblies.
  - Scanner assembly. For the HP LaserJet 3015, see [Scanner assembly](#). For the LaserJet 3020 and 3030, see [Scanner assembly](#).
  - Left cover. See [Printer side covers](#).
  - Rear cover and fuser cover. See [Rear cover and fuser cover](#).
  - Print cartridge door. See [Print-cartridge door](#).
  - Front cover. See [Front cover](#).
  - Scanner support frame. See [Scanner support frame](#).
  - ECU. See [Engine controller unit](#).

2. Remove four screws (callout 1). Remove the laser/scanner assembly.

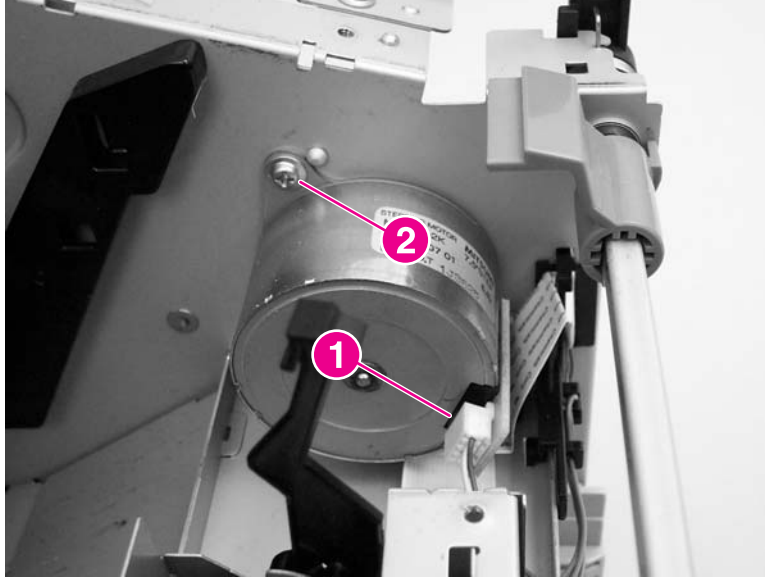


**Figure 5-140.** Remove the laser/scanner assembly

## Main motor

1. Remove the following assemblies.
  - Scanner assembly. For the HP LaserJet 3015, see [Scanner assembly](#). For the LaserJet 3020 and 3030, see [Scanner assembly](#).
  - Formatter. See [Formatter and line interface unit \(LIU\)](#)
  - Left cover. See [Printer side covers](#).
  - Rear cover and fuser cover. See [Rear cover and fuser cover](#).
  - Print cartridge door. See [Print-cartridge door](#).
  - Front cover. See [Front cover](#).
  - Scanner support frame. See [Scanner support frame](#).
  - ECU. See [Engine controller unit](#).
  - Laser/scanner assembly. See [Laser/scanner assembly](#).

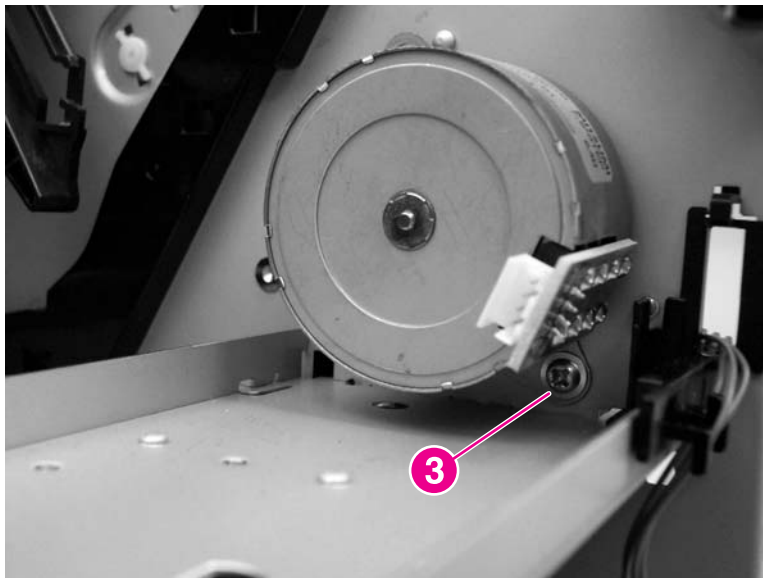
2. Disconnect the motor wire-harness connector (callout 1) and remove one screw (callout 2).



**Figure 5-141.**

**Remove the main motor (1 of 2)**

3. Remove one screw (callout 3), and remove the main motor.

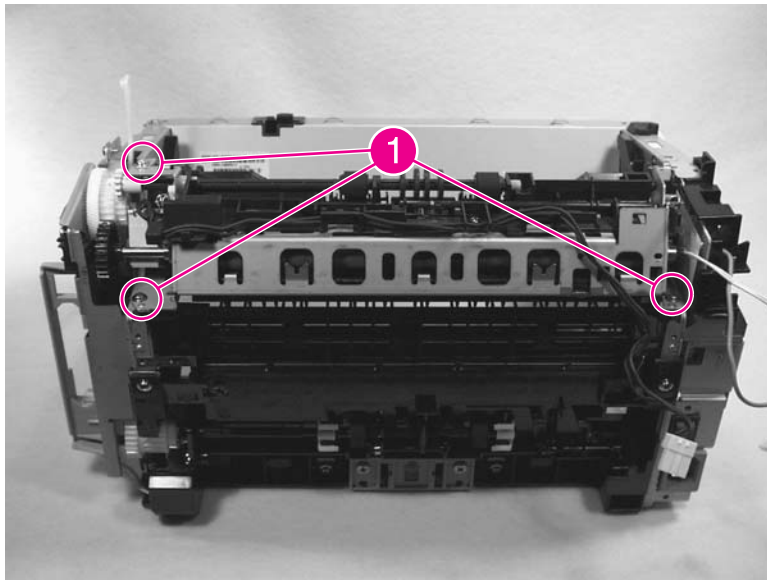


**Figure 5-142.**

**Remove the main motor (2 of 2)**

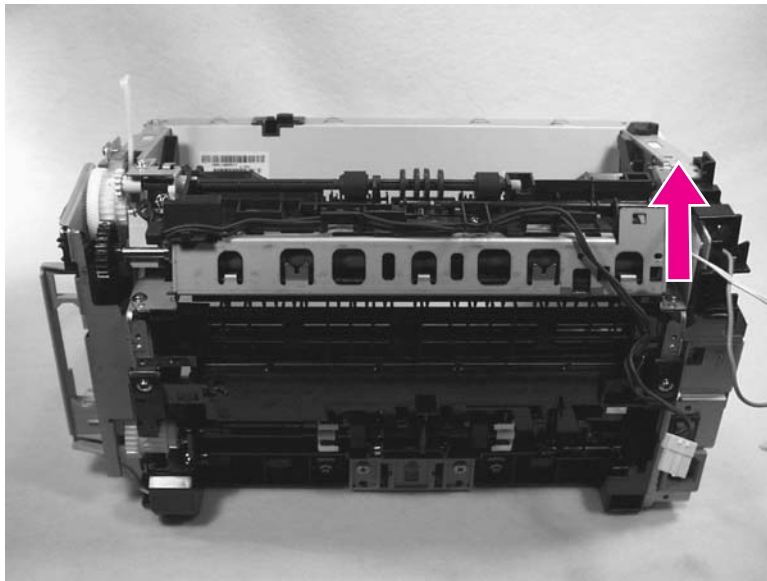
## Fuser

1. Remove the following assemblies.
  - Scanner assembly. For the HP LaserJet 3015, see [Scanner assembly](#). For the LaserJet 3020 and 3030, see [Scanner assembly](#).
  - Left cover. See [Printer side covers](#).
  - Rear cover and fuser cover. See [Rear cover and fuser cover](#).
  - Print cartridge door. See [Print-cartridge door](#).
  - Front cover. See [Front cover](#).
  - Scanner support frame and chassis reinforcement plate. See [Scanner support frame](#).
2. Disconnect cables from near the top of the engine power assembly and disconnect the large grounding wire from the back of the printer.
3. Disengage the wire-harnesses from the wire retainers to release the fuser assembly.
4. Remove three screws (callout 1; this figure shows the delivery-sensor PCB removed, which is not necessary).



**Figure 5-143.** Remove the fuser assembly (1 of 2)

5. Lift the fuser assembly at the right and remove the fuser assembly.



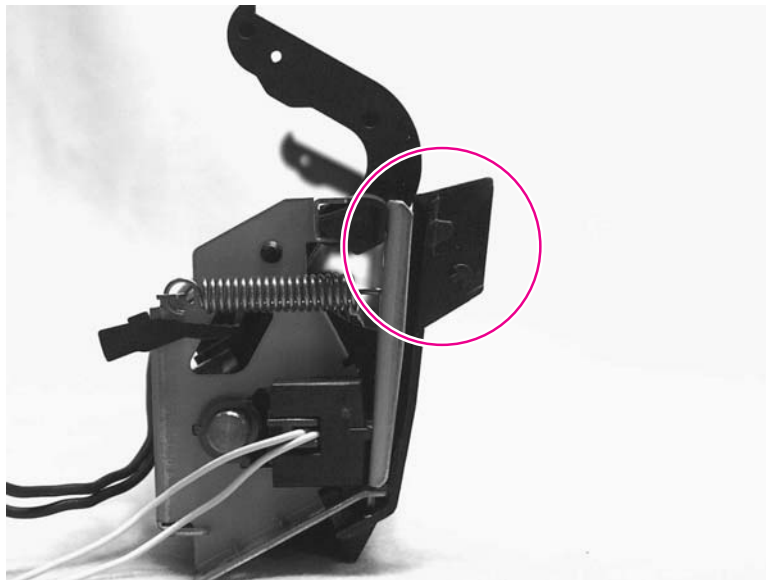
**Figure 5-144.** Remove the fuser assembly (2 of 2)

**CAUTION**

A plastic tab on the left side of the fuser assembly (see [Figure 5-145. Fragile tab on fuser assembly](#)) fits into the sheet metal. When installing the fuser assembly, avoid breaking this tab.

**Note**

When replacing the fuser assembly, be sure to transfer the delivery-sensor PCB from the old fuser to the new one.

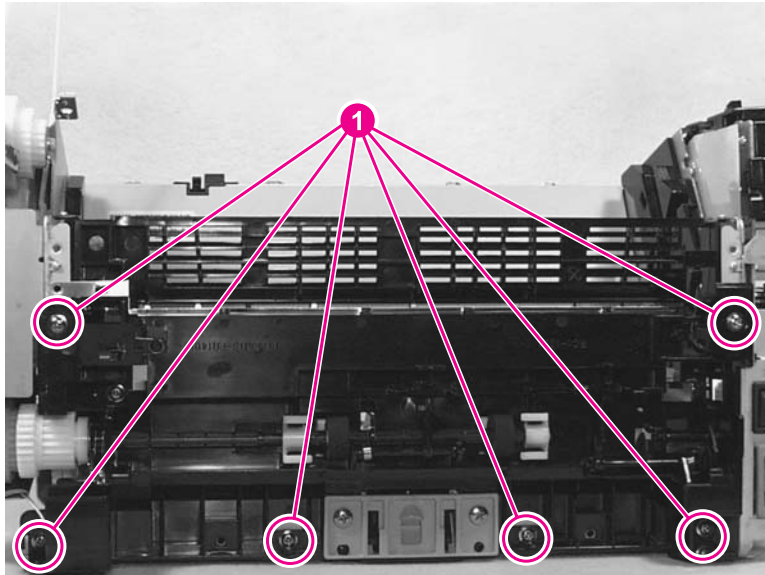


**Figure 5-145.** Fragile tab on fuser assembly



## Paper-pickup assembly

1. Remove the following assemblies.
  - Scanner assembly. For the HP LaserJet 3015, see [Scanner assembly](#). For the LaserJet 3020 and 3030, see [Scanner assembly](#).
  - Left cover. See [Printer side covers](#).
  - Rear cover and fuser cover. See [Rear cover and fuser cover](#).
  - Print cartridge door. See [Print-cartridge door](#).
  - Front cover. See [Front cover](#).
  - Transfer roller. See [Transfer roller](#).
  - Fuser. See [Fuser](#).
2. Unplug and remove any additional wire-harnesses as necessary to release the paper-pickup assembly. Unplug and remove the wire from the solenoid to the formatter.
3. Remove six screws (callout 1) and remove the assembly.



**Figure 5-146.** Remove the paper-pickup assembly



# 6

# Troubleshooting

This chapter provides information about the following topics.

Basic troubleshooting .....	188
Control-panel messages .....	193
Alert and warning messages .....	193
Critical error messages .....	201
Event-log codes.....	204
Solving image-quality problems .....	206
Checking the print cartridge .....	206
Solving print image-quality problems .....	206
Solving scanning (copying) image-quality problems .....	216
Repetitive image defect ruler .....	222
Solving paper-feed problems .....	223
Jams occur in the printer.....	223
Solving print paper-feed problems .....	225
Jams occur in the automatic document feeder (ADF).....	227
Solving scanner (copier) paper-feed problems .....	229
Solving problems with digital subscriber line (DSL) connections.....	231
Connecting additional devices.....	231
Functional checks .....	235
Control-panel test.....	235
Half self-test functional check .....	235
Drum rotation functional check .....	237
High-voltage contacts check .....	238
Updating the firmware code.....	240
Troubleshooting tools .....	241
Printing a configuration report, demonstration page, or menu structure .....	241
Printing all fax reports at once (HP LaserJet 3015 and 3030 only) .....	241
T.30 protocol trace (HP LaserJet 3015 and 3030 only) .....	241
Service-mode functions .....	262
Secondary service menu .....	262
Developer's menu .....	263
Adjusting the country/region code parameters.....	264
Soft reset.....	265
NVRAM init .....	265
System settings for localized products.....	266
Printer job language (PJL) software commands .....	268
Main wiring .....	269
Component locations, HP LaserJet 3015 all-in-one .....	272
Component locations, HP LaserJet 3020 and 3030 all-in-one.....	276
Component locations, HP LaserJet 3015, 3020 and 3030 printer (product base).....	277

## Basic troubleshooting

### Note

The HP LaserJet 3015 and 3030 all-in-one products have faxing capabilities. The HP LaserJet 3020 all-in-one product *does not* operate as a faxing device.

### Is Power-on successful?

When the product is connected to a grounded power source, the words **Hewlett Packard** appear with moving cursors to indicate that the firmware code is loading, and the printer motor rotates for approximately 5 seconds.

### Note

The flashing wavy lines that appear on the control-panel display during this period are normal.

Cause	Solution
No power is available because of a failed power source, cable, switch. (No LEDs are lit and the display is blank.)	<ol style="list-style-type: none"><li>1. Verify that the product is plugged in to a functional power source.</li><li>2. Verify that the power cable is functional and that the power switch is on.</li><li>3. Verify that FU101 on the power supply is not open (also check FU102 if present). See <a href="#">Main wiring</a>.</li><li>4. If all of these conditions are correct, replace the power supply. See <a href="#">Power supply</a>.</li></ol>
Printer motor does not rotate.	<ol style="list-style-type: none"><li>1. Verify that the print cartridge is present.</li><li>2. Verify that the product doors are closed.</li><li>3. Verify that media is loaded in the paper input tray. See <a href="#">Loading media</a>.</li><li>4. Verify that the printer-path-paper sensors are functional.</li><li>5. Verify that the wire-harness from the ECU is seated into the motor connector.</li><li>6. Verify that the motor is correctly mounted to the product chassis.</li><li>7. If all of these conditions are correct, replace the ECU. See <a href="#">Engine controller unit</a>.</li><li>8. If, after replacing the ECU, the printer motor still does not rotate, replace the motor. See <a href="#">Main motor</a>.</li></ol>

### Does the product achieve the ready state?

The motor rotates, but the lights are not on.

Cause	Solution
The formatter is damaged or has a loose connection.	Verify that the formatter cables are properly connected. If all cables are undamaged and seated correctly but the problem persists, replace the formatter. See <a href="#">Formatter and line interface unit (LIU)</a> .

## Is the product ready?

The control panel should function without error messages.

Cause	Solution
An error message appears on the control-panel display.	Consult the list of common messages which appears later in this chapter, to correct the error. See <a href="#">Control-panel messages</a> .
Control panel is not functional.	Verify that the control panel cable is seated into both the control panel and the scanner formatter. Also check the connections between the scanner motor controller board and the formatter. If all cables are undamaged and seated correctly but the problem persists, replace the control panel. <b>HP LaserJet 3015</b> , see <a href="#">Control-panel assembly</a> . <b>HP LaserJet 3020 and 3030</b> , see <a href="#">Control-panel assembly</a> .
Control-panel display is blank, but the LEDs are lit.	<ol style="list-style-type: none"><li>1. Print a page from a software program. If the page prints, verify that the control-panel cables are correctly seated.</li><li>2. If the problem persists, replace the control panel. <b>HP LaserJet 3015</b>, see <a href="#">Control-panel assembly</a>. <b>HP LaserJet 3020 and 3030</b>, see <a href="#">Control-panel assembly</a>.</li><li>3. If the problem persists, replace the formatter. See <a href="#">Formatter and line interface unit (LIU)</a>.</li></ol>
Control-panel display and LEDs function, but buttons do not work.	Replace the control panel. <b>HP LaserJet 3015</b> , see <a href="#">Control-panel assembly</a> . <b>HP LaserJet 3020 and 3030</b> , see <a href="#">Control-panel assembly</a> .

## Does the demo page print?

Print a demo page by opening the reports menu and select **Demo Page**.

Cause	Solution
The media does not move smoothly through the paper path.	Make sure that the media meets specifications detailed in the <i>HP LaserJet Printer Family Print Media Guide</i> .  If the media is consistently jamming and the paper path is clear, replace either the paper-pickup assembly or the fuser, depending on where the jam occurs. See <a href="#">Paper-pickup assembly</a> or <a href="#">Fuser</a> .
The documents print with poor print quality.	See <a href="#">Solving image-quality problems</a> .

## Is the copy function operational?

Place the configuration report into the ADF and make a copy. The report should feed smoothly through the ADF and copies should print without print-quality problems. Make a copy from the flatbed as well (HP LaserJet 3020 and 3030 only).

Cause	Solution
Poor copy quality from the flatbed (HP LaserJet 3020 and 3030).	<ol style="list-style-type: none"> <li>1. If the print quality from the internal tests and the copy from the ADF are acceptable, clean the flatbed glass. See <a href="#">Cleaning the product</a>.</li> <li>2. Adjust the <b>LIGHTER/DARKER</b> setting on the control panel.</li> <li>3. If, after performing the maintenance, the problem persists, replace the ADF assembly (the ADF is part of the flatbed lid). See <a href="#">Flatbed lid</a>.</li> </ol>
Poor copy quality from the ADF (HP LaserJet 3015).	<ol style="list-style-type: none"> <li>1. Clean the ADF scanner glass. See <a href="#">Cleaning the product</a>.</li> <li>2. Adjust the <b>LIGHTER/DARKER</b> setting on the control panel.</li> <li>3. If the problem persists, replace the scanner assembly. See <a href="#">Scanner assembly</a>.</li> </ol>
Media does not move smoothly through the ADF path.	Clean the ADF pickup roller and ADF separation pad (see <a href="#">Cleaning the print-cartridge area</a> ). If the problem persists, replace the ADF pickup roller and ADF separation pad (see <a href="#">User replaceable parts</a> ). If the problem persists, for the HP LaserJet 3015 replace the scanner assembly (see, <a href="#">Scanner assembly</a> ). . If the problem persists, for the HP LaserJet 3020, and 3030 replace the ADF assembly (the flatbed lid contains the ADF assembly; see, <a href="#">Flatbed lid</a> ).

## Does the product send a fax? (HP LaserJet 3015 and 3030 only)

Connect the phone line and verify the dial tone (using a hand set, if necessary). Attempt to send a fax.

Cause	Solution
The fax cord is plugged into the additional device connector on the back of the product.	Verify that the fax cord is plugged into the fax interface port ( the bottom phone cord connector) on the back of the product. See <a href="#">Overview of products</a> .
The telephone line is not operational or the product is not plugged into the telephone line.	Make sure that the product is plugged into a telephone line that works (press fax/send and listen for a dial tone).
The phone cord is faulty or is plugged into the wrong connector.	Try plugging the phone cord into the other connector. Try a new cord.
The product's fax settings are set incorrectly.	Review and reset the product's fax settings. See <a href="#">Control-panel menu structure</a> .
The LIU is not operational.	Replace the LIU. If the problem persists, replace the formatter. See <a href="#">Formatter and line interface unit (LIU)</a> .
If the customer is using a digital subscriber line (DSL) connection, the setup might be incorrect.	See <a href="#">Solving problems with digital subscriber line (DSL) connections</a> for information about setting up DSL connections.

## Does the product receive a fax? (HP LaserJet 3015/3030 only)

Use another fax machine to send a fax to the product.

Cause	Solution
The fax cord is plugged into the additional device connector on the back of the product.	Verify that the fax cord is plugged into the fax interface port ( the bottom phone cord connector) on the back of the product.
Too many telephone products are plugged in, or telephone products are not connected in the correct order.	Make sure that the product is the only product on the telephone line and try again to receive the fax (press fax/send and listen for a dial tone).
The product's fax settings are set incorrectly.	Review and reset the product's fax settings. See <a href="#">Control-panel menu structure</a> .
The line interface unit (LIU) is not operational.	Replace the LIU. If the problem persists, replace the formatter. See <a href="#">Formatter and line interface unit (LIU)</a> .
If the customer is using a digital subscriber line (DSL) connection, the setup might be incorrect.	See <a href="#">Solving problems with digital subscriber line (DSL) connections</a> for information about setting up DSL connections.

## Is the software installed correctly?

Cause	Solution
Software is not installed or an error occurred during software installation.	Uninstall and then reload the product software. Make sure that the correct installation procedure and the correct port setting is used.

## Does the product print from the computer?

Connect the parallel cable or USB cable between the product and the computer. Use a word-processing program to send a print job to the product.

Cause	Solution
The cable is not connected correctly.	Reconnect the cable.
An incorrect driver is selected.	Select the correct driver.
Other products are connected to the parallel port or USB port.	Disconnect the other products and try again to print.
An LPT port driver problem exists in Microsoft Windows.	Reset the computer's port settings. Verify that the port is set for bidirectional communication.
A problem exists in the device manager.	Check the computer system settings and fix any device problems.
The formatter has failed.	Replace the formatter. See <a href="#">Formatter and line interface unit (LIU)</a> .

## Does the product scan to the computer?

Initiate a scan from either the computer's basic desktop software or from the product.

Cause	Solution
Other products are connected to the parallel port or USB port.	Disconnect the other products and try again to scan.
The computer's parallel-port hardware is not bidirectional.	Check the computer documentation to see if the port configuration can be changed. Make sure the correct port is selected.
The BIOS settings for the parallel port are set incorrectly.	Reset the computer's port settings. If the problem persists, reset the BIOS settings in CMOS.
Polling is turned off in HP Toolbox, or HP Toolbox is not running.	Start HP Toolbox and turn on polling.

## Control-panel messages

The majority of the control-panel messages are intended to guide the user through normal operation. The control-panel messages indicate the status of the current operation, and include a page count on the second line of the display, if appropriate. When the product is receiving fax data, print data, or scanning commands, control-panel messages indicate this status. In addition, alert messages, warning messages, and critical error messages indicate situations that might require some action.

---

### Note

**HP LaserJet 3015 and 3030 only:** This product has been tested with the supplied two-wire telephone cord to meet RJ11 specifications. If you are experiencing faxing problems, make sure that the supplied phone cord or an equivalent cord is installed.

---

## Alert and warning messages

Alert and warning messages appear temporarily and might require the user to acknowledge the message by pressing **MENU/ENTER** to resume or by pressing **CANCEL** to cancel the job. With certain warnings, the job might not complete or the print quality might be affected. If the alert or warning message is related to printing and the auto-continue feature is on, the product will attempt to resume the printing job after the warning has appeared for 10 seconds without acknowledgement.

---

### Note

Some control-panel error messages might not apply to the product being serviced, and therefore they will not appear on the control-panel display. For example, fax error messages will not appear on the control-panel display for the HP LaserJet 3020 all-in-one product.

---

---

### Note

Event-log codes are not listed here. For a list of event-log codes, see [Event-log codes](#).

---

**Table 6-1. Alert and warning messages**

Control panel message	Event log error message	Description	Recommended action
<b>###: [Group Name] Phbook/SpeedDial</b> (HP LaserJet 3015 and 3030 only)	None	The product is waiting for the programmed one-touch button to be pressed or add a speed-dial code to a group-dial code.	Begin adding fax numbers to the group-dial code. See “To manage group-dial entries” in the fax guide on the product CD.
<b>Canceled copy. Clear document</b>	None	The <b>CANCEL</b> button was pressed to cancel the current job while pages were feeding from the document feeder. The cancel process will not automatically clear the document feeder.	Open the ADF cover or raise the flatbed lid (HP LaserJet 3020 and 3030 only), remove the jammed item, and close the door or lid. Then, clear the items in the document feeder tray and start over.
<b>Canceled scan. Clear document</b>	None	The <b>CANCEL</b> button was pressed to cancel the current job while pages were feeding from the document feeder. The cancel process will not automatically clear the document feeder.	Open the ADF cover or raise the flatbed lid (HP LaserJet 3020 and 3030 only), remove the jammed item, and close the door or lid. Then, clear the items in the document feeder tray and start over.

**Table 6-1. Alert and warning messages (continued)**

Control panel message	Event log error message	Description	Recommended action
<b>Canceled send. Clear document</b>	None	The <b>CANCEL</b> button was pressed to cancel the current job while pages were feeding from the document feeder tray. The cancel process will not automatically clear the document feeder.	Open the ADF cover or raise the flatbed lid (HP LaserJet 3020 and 3030 only), remove the jammed item, and close the door or lid. Then, clear the items in the document feeder tray and start over.
<b>Cleaning Mode. Wait 1-3 min.</b>	None	The product is running an internal cleaning cycle.	Wait for the product to finish the cleaning cycle. The message will clear when the cycle is finished.
<b>Comm. error</b> (HP LaserJet 3015 and 3030 only)	None	Fax communication error occurred between the product and the sender or receiver. For descriptions of communication errors, see <a href="#">Table 6-4. Fax receive codes</a> , and <a href="#">Table 6-5. Fax send codes</a> .	Allow the product to retry sending the fax. Unplug the product telephone cord from the wall, plug in a telephone, and try making a call. Plug the product phone cord into a jack for another phone line.  Reseat or replace the cord. Try a different phone cord.  If the error persists, replace the LIU. See <a href="#">Formatter and line interface unit (LIU)</a> .
<b>Device error. [enter] to cont.</b>	None	An internal error occurred in the product.	Press <b>MENU/ENTER</b> to resume the job.
<b>Device is busy. Try again later</b>	None	The product is currently in use.	Wait for the product to finish the current job.
<b>Doc feeder jam Clear, Reload</b>	None	A piece of media is jammed in the document feeder tray.	Open the ADF cover or raise the flatbed lid (LJ 3020/3030 only), remove the jammed item (see, <a href="#">Solving paper-feed problems</a> ), and close the door or lid. Then, clear the items in the document feeder tray and start over.  If the error persists, replace the ADF separation pad and ADF pickup roller. See, <a href="#">User replaceable parts</a> .
<b>Document feeder mispick. Reload</b>	None	Media in the document feeder tray was not picked up.	Remove the media from the document feeder tray and then reload it.  If the error persists, replace the ADF pickup roller and ADF separation pad. See, <a href="#">User replaceable parts</a> .



**Table 6-1. Alert and warning messages (continued)**

Control panel message	Event log error message	Description	Recommended action
<b>Door open or no print cartridge</b>	None	The print cartridge door is open or the print cartridge is not installed properly.	<ol style="list-style-type: none"> <li>1. Check that the print cartridge door is completely closed.</li> <li>2. Forcefully open and close the print-cartridge door to make sure that the print cartridge is seated.</li> <li>3. Check that the print cartridge is correctly installed.</li> </ol>
<b>Engine comm. error</b>	None	The product experienced an internal communication error.	Warning message only. Job output might be affected.
<b>Fax is busy</b> <b>Canceled send</b> (HP LaserJet 3015 and 3030 only)	None	The receiving fax line was busy. The product has canceled sending the fax.	<p>Call the recipient to ensure that their fax machine is turned on and ready.</p> <p>Check that you are dialing the correct fax number.</p> <p>Check that the <b>Redial if busy</b> option is enabled. See, <a href="#">Control-panel menu structure</a>.</p> <p>Check for a dial tone on the phone line by pressing <b>FAX/SEND</b>.</p> <p>Make sure that the phone line is working by disconnecting the product, plugging in a telephone to the phone line, and making a voice call.</p> <p>Plug the product phone cord into a jack for another phone line, and try sending the fax again.</p> <p>Try a different phone cord.</p> <p>Update the firmware. See <a href="#">Updating the firmware code</a>.</p> <p>If the error persists, replace the LIU. See, <a href="#">Formatter and line interface unit (LIU)</a>.</p>

**Table 6-1. Alert and warning messages (continued)**

Control panel message	Event log error message	Description	Recommended action
<p><b>Fax is busy</b>  <b>Redial pending</b>                      (HP LaserJet 3015 and 3030 only)</p>	None	<p>The fax line to which you were sending a fax was busy. The product automatically redials the busy number. (See “Changing the redial setting” in the fax guide on the product CD.)</p>	<p>Allow the product to retry sending the fax.</p> <p>Call the recipient to ensure that the fax machine is turned on and ready.</p> <p>Check that you are dialing the correct fax number.</p> <p>Check for a dial tone on the phone line by pressing <b>FAX/SEND</b>.</p> <p>Make sure that the phone line is working by disconnecting the product, plugging in a telephone to the phone line, and making a voice call.</p> <p>Plug the product phone cord into a jack for another phone line, and try sending the fax again.</p> <p>Try a different phone cord.</p> <p>Update the firmware. See <a href="#">Updating the firmware code</a>.</p> <p>If the error persists, replace the LIU. See, <a href="#">Formatter and line interface unit (LIU)</a>.</p>
<p><b>Fax memory full</b>  <b>Canceling recv.</b>                      (HP LaserJet 3015 and 3030 only)</p>	None	<p>During the fax transmission, the product ran out of memory. Only the pages that fit into memory will be printed.</p>	<p>Print all of the faxes and have the sender resend the fax. Cancel all fax jobs or clear the faxes from memory (see “Deleting faxes from memory” in the fax guide on the product CD).</p>
<p><b>Fax memory full</b>  <b>Canceling send</b>                      (HP LaserJet 3015 and 3030 only)</p>	None	<p>During the fax job, the memory filled. All pages of the fax have to be in memory for a fax job to work correctly. Only the pages that fit into memory were sent.</p>	<p>Print all received faxes or wait until all pending faxes are sent.</p> <p>Cancel all fax jobs or clear the faxes from memory (see “Deleting faxes from memory” in the fax guide on the product CD).</p>

**Table 6-1. Alert and warning messages (continued)**

Control panel message	Event log error message	Description	Recommended action
<p><b>Fax recv. error</b> (HP LaserJet 3015 and 3030 only)</p>	None	An error occurred while trying to receive a fax.	<p>Ask the sender to resend the fax.</p> <p>Try faxing back to the sender or another fax machine.</p> <p>Check for a dial tone on the phone line by pressing <b>FAX/SEND</b>.</p> <p>Check that the telephone cord is securely connected by unplugging and replugging the cord.</p> <p>Make sure that the phone is working by disconnecting the product, plugging in a telephone to the phone line, and making a voice call.</p> <p>Turn off error-correction mode (ECM), and turn off V.34. Ask the sender to resend the fax.</p> <p>Turn off error-correction mode (ECM) and turn off V.34. Ask the sender to resend the fax.</p> <p>Connect the product to a different phone line.</p> <p>If the error persists, replace the LIU. See, <a href="#">Formatter and line interface unit (LIU)</a>.</p>
<p><b>Fax Send error</b> (HP LaserJet 3015 and 3030 only)</p>	None	An error occurred while trying to send a fax.	<p>Try resending the fax.</p> <p>Check for a dial tone on the phone line by pressing <b>FAX/SEND</b>.</p> <p>Try faxing to another fax number.</p> <p>Check that the telephone cord is securely connected by unplugging and replugging the cord.</p> <p>Make sure that the phone is working by disconnecting the product, plugging in a telephone to the phone line, and making a voice call.</p> <p>Connect the product to a different phone line.</p> <p>If the error persists, replace the LIU. See, <a href="#">Formatter and line interface unit (LIU)</a>.</p>
<p><b>Fit to Page on flatbed only</b> (HP LaserJet 3020 and 3030 only)</p>	None	The copy reduce/enlarge feature only applies to flatbed copies.	Use the flatbed or select another reduction/enlargement setting.

**Table 6-1. Alert and warning messages (continued)**

Control panel message	Event log error message	Description	Recommended action
<b>Group dial not allowed in group</b> (HP LaserJet 3015 and 3030 only)	None	The speed-dial code that you typed is programmed for a group. Adding a group-dial to another group-dial is not allowed.	Add one-touch buttons (programmed as an individual speed dial) or speed-dial codes to a group-dial.
<b>Invalid date</b> (HP LaserJet 3015 and 3030 only)	None	An invalid date was entered, such as June 35.	Re-enter the date.
<b>Invalid entry</b>	None	Invalid data or response.	Correct the entry.
<b>Mem. low 1 copy</b> <b>Press [cancel]</b>	None	The product completed making one copy. The remaining copies have been canceled because of low product memory.	Press <b>CANCEL</b> to clear the error. Break the job into smaller jobs that contain fewer pages.
<b>Memory is low</b> <b>Try again later</b>	None	The product does not have enough memory to start a new job.	Wait until the current job is finished before starting a new job.  Remove a surge protector if one is being used. Plug the printer directly into the wall socket. Use the power switch to turn the product on.
<b>Memory is low.</b> <b>Press [enter]</b>	None	The product memory has been almost completely filled.	Allow the product to finish the job, or press <b>MENU/ENTER</b> to cancel the job.
<b>Memory low</b> <b>Only 1 copy made</b>	None	Break the job into smaller jobs that contain fewer pages.	Continue completing the collated copy job.
<b>No Dial Tone</b> (HP LaserJet 3015 and 3030 only)	None	The product could not detect a dial tone.	Check for a dial tone on the phone line by pressing <b>FAX/SEND</b> .  Unplug the telephone cord from both the product and the wall and replug the cord.  Unplug the product telephone cord from the wall, plug in a telephone, and try making a call.  Plug the product phone cord into a jack for another phone line. See "Changing the detect-dial-tone setting" in the fax guide on the product CD.  Update the firmware. See <a href="#">Updating the firmware code</a> .  If the error persists, replace the LIU. If, after replacing the LIU, the error persists, replace the formatter. See, <a href="#">Formatter and line interface unit (LIU)</a> .
<b>No document sent</b> (HP LaserJet 3015 and 3030 only)	None	The product did not scan any pages or receive a file from the computer to transmit as a fax.	Rescan the pages or resend the file from the computer to transmit as a fax.

**Table 6-1. Alert and warning messages (continued)**

Control panel message	Event log error message	Description	Recommended action
<p><b>No fax answer.</b> <b>Canceled send</b> (HP LaserJet 3015 and 3030 only)</p>	<p>None</p>	<p>Attempts to redial a fax number failed, or the “Redial-no answer” option was turned off.</p>	<p>Call the recipient to ensure that their fax machine is on and ready.</p> <p>Check that you are dialing the correct fax number.</p> <p>Check that the redial option is enabled. See <a href="#">Control-panel menu structure</a>.</p> <p>Unplug the telephone cord from both the product and the wall and replug the cord.</p> <p>Unplug the product telephone cord from the wall, plug in a telephone, and try making a call.</p> <p>Plug the product phone cord into a jack for another phone line.</p> <p>Update the firmware. See <a href="#">Updating the firmware code</a>.</p> <p>If the error persists, replace the formatter. See, <a href="#">Formatter and line interface unit (LIU)</a>.</p>
<p><b>No fax answer.</b> <b>Redial pending</b> (HP LaserJet 3015 and 3030 only)</p>	<p>None</p>	<p>The receiving fax line did not answer. The product attempts to redial after a few minutes.</p>	<p>Allow the product to retry sending the fax.</p> <p>Call the recipient to ensure that their fax machine is on and ready.</p> <p>Check that you are dialing the correct fax number.</p> <p><i>After</i> the device stops trying to redial, do the following.</p> <p>Unplug the product telephone cord from the wall, plug in a telephone, and try making a call.</p> <p>Plug the product phone cord into a jack for another phone line.</p> <p>Try a different phone cord.</p> <p>Update the firmware. See <a href="#">Updating the firmware code</a>.</p> <p>If the error persists, replace the LIU. See, <a href="#">Formatter and line interface unit (LIU)</a>.</p>

**Table 6-1. Alert and warning messages (continued)**

Control panel message	Event log error message	Description	Recommended action
<b>No fax detected</b> (HP LaserJet 3015 and 3030 only)	None	The product answered the incoming call but did not detect that a fax machine was calling.	Allow the product to retry receiving the fax.  Try a different phone cord.  Plug the product phone cord into a jack for another phone line.  Update the firmware. See <a href="#">Updating the firmware code</a> .  If the error persists, replace the formatter. See, <a href="#">Formatter and line interface unit (LIU)</a> .
<b>No fax pages to reprint</b> (HP LaserJet 3015 and 3030 only)	None	The product attempted to execute "Reprint last" fax when nothing was in memory.	Receive a fax before attempting to use this option.
<b>Out of range</b>	None	An invalid number was typed.	Retype the number.
<b>Page too complex</b> [enter] to cont.	none	The product could not print the current page because of its complexity.	Press <a href="#">MENU/ENTER</a> to clear the message.  Allow the product to finish the job, or press <a href="#">CANCEL</a> to cancel the job.
<b>Phone Book ### is empty</b> (HP LaserJet 3015 and 3030 only)	None	The one-touch button or speed-dial code has not been programmed and therefore cannot be added to a group.	Press <a href="#">MENU/ENTER</a> to program the one-touch or speed-dial. If you want to program a group-dial, press <a href="#">CANCEL</a> and use the control panel menu to create a new group. Press <a href="#">CANCEL</a> if you do not want to program the one-touch or speed-dial.
<b>Printer jam</b> Clear paper path	None	The product has detected a jam.	Clear the jam (see, <a href="#">Solving paper-feed problems</a> ). The job should continue to print. If it does not, try reprinting the job.  If media jams frequently, see <a href="#">Maintenance</a> .
<b>Printer tray is empty. Add paper</b>	None	The media input tray is empty.	Load media. If media is already loaded, remove it.  Check for and remove any jam (see, <a href="#">Solving paper-feed problems</a> ), and then reload the stack of media in the media input tray.
<b>Scanner reserved for PC scan</b>	None	A computer is using the product to create a scan.	Wait until the computer scan has finished, or cancel the scan from the computer software, or press <a href="#">CANCEL</a> .

**Table 6-1. Alert and warning messages (continued)**

Control panel message	Event log error message	Description	Recommended action
<b>Scanning error Cannot connect</b>	None	The product cannot transmit scan information to a computer.	Make sure that the connection cable is not loose or damaged. Replace the cable if necessary, and try the scan again.
<b>Settings cleared</b>	None	The product has cleared job settings.	Re-enter any appropriate job settings.

## Critical error messages

Critical error messages can indicate some kind of failure. Cycling the power might fix the problem. If a critical error persists, the product might require service.

**Table 6-2. Critical error messages**

Control panel message	Event log error message	Description	Recommended action
<b>50 Fuser Error</b>	None	The product has experienced an internal hardware error.	<p>Turn off the power switch, wait at least <b>20 minutes</b>, and then turn on the power switch and wait for the product to initialize.</p> <hr/> <p><b>Note</b></p> <p>The device power <b>must</b> remain off for at least 20 minutes for the fuser to cool down and properly reset.</p> <p>If a surge protector is being used, remove it. Plug the printer directly into the wall socket. Use the power switch to turn the product on.</p> <p>Check the cabling connections to the heating element.</p> <p>If, the error persists, replace the fuser. See, <a href="#">Fuser</a>.</p>

**Table 6-2. Critical error messages (continued)**

Control panel message	Event log error message	Description	Recommended action
<p><b>51 Laser Error</b></p>	<p>None</p>	<p>The product has experienced an internal hardware error.</p>	<p>Turn off the power by using the power switch, wait at least 30 seconds, and then turn on the power and wait for the product to initialize.</p> <p>Check the cabling connections to the laser scanner assembly.</p> <p>Try connecting the product to a different power source or surge protector.</p> <p>If the error persists, replace the laser/scanner assembly. <b>HP LaserJet 3015:</b> see, <a href="#">Scanner assembly</a>. <b>HP LaserJet 3020 and 3030:</b> see, <a href="#">Scanner assembly</a>.</p>
<p><b>52 Scanner Error</b></p>	<p>None</p>	<p>The product has experienced an internal hardware error.</p>	<p>Turn off the power by using the power switch, wait at least 30 seconds, and then turn on the power and wait for the product to initialize.</p> <p>Make sure that the flat, flexible cables (FFCs) are properly connected on the formatter and on the laser/scanner.</p> <p>Check the FFC connection between the formatter and the scanner.</p> <hr/> <p><b>Note</b></p> <p>Do not bend or fold the FFCs during the removal or reinstallation process.</p> <hr/> <p>Try connecting the product to a different power source or surge protector.</p> <p>If the error persists, replace the laser scanner assembly. See <a href="#">Laser/scanner assembly</a>.</p>
<p><b>79 Error</b> <b>Turn off then on</b></p>	<p>None</p>	<p>The product has experienced an internal firmware error.</p>	<p>Turn off the power by using the power switch, wait at least 30 seconds, and then turn on the power and wait for the product to initialize.</p> <p><b>HP LaserJet 3020 and 3030 only:</b> update the firmware.</p> <p>If the error persists, replace the formatter. See <a href="#">Formatter and line interface unit (LIU)</a>.</p>



**Table 6-2. Critical error messages (continued)**

Control panel message	Event log error message	Description	Recommended action
<p><b>ADF door is open</b> (HP LaserJet 3020 and 3030 only)</p>	<p>None</p>	<p>The ADF lid is open or a sensor is malfunctioning.</p>	<p>Make sure the ADF lid is closed.</p> <p>If the ADF motor cover was removed during product servicing, make sure that the cover is installed correctly and that the ADF lid can close properly. See <a href="#">Figure 5-54. ADF cover correctly installed.</a></p> <p>Make sure that the ADF lid is completely seated. If necessary, remove the ADF and reinstall it.</p> <p>Turn off the power by using the power switch, wait at least 30 seconds, and then turn on the power and wait for the product to initialize.</p> <p>Try another power source.</p> <p>If the sensor is not functioning, replace the ADF( the ADF is part of the flatbed lid). See <a href="#">Flatbed lid.</a></p>
<p><b>CIS Scanner Error (HP LaserJet 3015)</b></p>	<p>None</p>	<p>The scanner assembly experienced an internal error.</p>	<p>Turn off the power by using the power switch, wait at least 30 seconds, and then turn on the power and wait for the product to initialize.</p> <p>Try another power source.</p> <p>If the error persists, replace the scanner assembly. See, <a href="#">Scanner assembly.</a></p>

**Table 6-2. Critical error messages (continued)**

Control panel message	Event log error message	Description	Recommended action
<b>Scanner Bulb Failure (HP LaserJet 3020 and 3030 only)</b>	None	The scanner assembly experienced an error in scanner bulb functionality.	<p>Turn off the power by using the power switch, wait at least 30 seconds, and then turn on the power and wait for the product to initialize.</p> <p>Try another power source.</p> <p>If the error persists, lift the flatbed to see if the scanner bulb is illuminating. If it is not illuminating, replace the scanner assembly. See, <a href="#">Scanner assembly</a>.</p> <p>If the bulb is illuminating, the scan module may be too far to the right to find the calibration strip during startup. Follow this procedure to move the scan module so it begins the startup cycle farther to the left:</p> <ol style="list-style-type: none"> <li>1. Cycle the power and watch the movement of the scan module. The scan module will move to the left and the bulb will illuminate. When it does, cycle the power.</li> <li>2. Repeat the first step until the scan module is about 3 centimeters (about 1 inch) from the right edge of the scan glass.</li> <li>3. Turn on power by using the power switch.</li> </ol> <p>If the error persists, replace the scanner assembly. See, <a href="#">Scanner assembly</a>.</p>

## Event-log codes

These codes appear in the event-log section of the configuration report. Use this table to associate an event-log code with a description of the event.

**Table 6-3. Event-log codes**

Event code	Event sub-code	Event
10	the line in the file at which the event occurred	asserts
20	10	receive-fax directory is missing
20	20	send-fax directory is missing
20	30	send-ID file is corrupted

**Table 6-3. Event-log codes (continued)**

Event code	Event sub-code	Event
20	40	receive-ID file is corrupted
20	50	fax log is corrupted
20	60	flash init as a result of a firmware upgrade
20	6060	write to flash failed
79	2	access error
79	3	address error
79	4	illegal instruction
79	8	privilege violation
79	9	trace fault
79	10	unimplemented line-a opcode
79	11	unimplemented line-f opcode
79	14	format error
79	15	uninitialized interrupt
79	120	ASIC fault
79	5 or 6 or 7	reserved
30016	0	insufficient memory
30017	0	print page punt
30035	0	NVRAM error
30036	0	NVRAM service error
30108	0	MIO connection break
30109	0	data communication error
30110	0	MIO buffer overflow
30111	0	parallel buffer overflow
35028	0	bad MIO
35031	0	invalid personality
50003	0	bad fuser
50004	0	bad beam detect
50005	0	bad scanner motor
50007	0	engine communication error
50012	0	bad malfunction
50013	0	laser malfunction

## Solving image-quality problems

If the problem occurs when printing, see [Solving print image-quality problems](#).

If the problem occurs when copying or scanning, see [Solving scanning \(copying\) image-quality problems](#).

Also, see [Solving paper-feed problems](#) and [Jams occur in the automatic document feeder \(ADF\)](#).

---

### Note

Some image-quality problems can be isolated by performing printer functional tests. See [Functional checks](#). Image quality problems can also be caused by using cables that are not IEEE-1284 compliant.

---

## Checking the print cartridge

Image-formation defects are frequently the result of problems in the print cartridge. If the source of the defect is not immediately evident, always replace the print cartridge before troubleshooting image defects.

Use the following checklist to make sure that the print cartridge is still operable.

- Make sure that the print cartridge is seated properly.
- Check the print cartridge to see if it has been disassembled or refilled.
- Inspect the print cartridge to see if toner is leaking through worn seals.
- Check the surface of the photosensitive drum in the cartridge to see if it has been damaged or scratched. Touching the drum contaminates the photosensitive surface and can cause spotting and image defects.
- Blurred areas on printed pages indicate that the photosensitive drum in the cartridge has been overexposed to light. Because overexposure to light causes permanent damage to the photosensitive drum, the cartridge should be replaced.

## To redistribute the toner in the print cartridge

Before installing a new print cartridge or when the toner begins to run low, redistribute the toner by rotating the cartridge back and forth five or six times.

## Solving print image-quality problems

Use the following tables to help solve problems with printed pages.

---

### Note

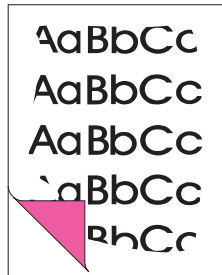
Some image-quality problems can be isolated by performing printer functional tests. See [Functional checks](#). Image-quality problems can also be caused by using cables that are not IEEE-1284 compliant.

---

Pages do not print.

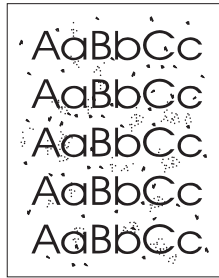
Cause	Solution
The product is not plugged in, or the power switch is not on.	Make sure that the product is plugged into a working wall outlet or power strip and that the power switch is turned on.
The computer cable is loose.	Check that the parallel cable or USB cable between the product and the computer is securely connected.
The tape was not removed from the print cartridge.	Remove the print cartridge, remove the tape, and reinstall the print cartridge.
The print cartridge is out of toner.	Replace the print cartridge.
The media does not meet HP specifications (for example, it is too moist or too rough).	Make sure that the media meets specifications detailed in the <i>HP LaserJet Printer Family Print Media Guide</i> .

Parts of the page around the edges are not printing.



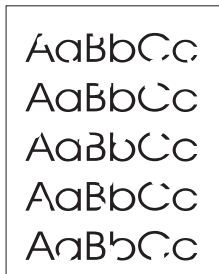
Cause	Solution
The product cannot print to the edge of the paper. The printer has minimum margins on each edge of 6 mm (0.25 inch).	To fit the image into this printable area, slightly reduce the size of the image.
The reduction setting is set incorrectly.	Check the reduction setting in the “Print” or “Setup” window from within the program that you are using.

Toner specks appear on the printed page.



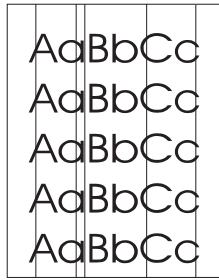
Cause	Solution
The media does not meet HP specifications (for example, it is too moist or too rough).	Make sure that the media meets specifications detailed in the <i>HP LaserJet Printer Family Print Media Guide</i> .
The print path needs to be cleaned.	Clean the print path. See, <a href="#">Cleaning the product</a> and <a href="#">Cleaning the print-cartridge area</a> .

Characters are only partially printed (also referred to as dropouts).



Cause	Solution
A single sheet of paper is defective.	Try reprinting the job.
The print density needs to be adjusted.	Adjust the print density from the HP Toolbox.
The moisture content of the paper is inconsistent, or the paper has moist or wet spots on the surface.	Make sure that the media meets specifications detailed in the <i>HP LaserJet Printer Family Print Media Guide</i> .
The paper was damaged by inconsistent manufacturing processes.	Make sure that the media meets specifications detailed in the <i>HP LaserJet Printer Family Print Media Guide</i> .
<b>Draft</b> mode or <b>EconoMode</b> is selected in the driver.	Try the normal or best setting.
The print cartridge is defective.	Replace the print cartridge.

Vertical lines appear on the printed page.



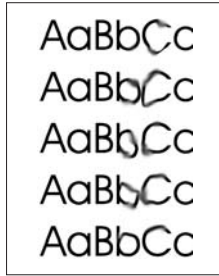
Cause	Solution
The priority input tray is not in place.	Adjust the priority input tray.
The photosensitive drum inside the print cartridge is scratched.	Replace the print cartridge.
The fuser is damaged or has an obstruction.	Replace the fuser. See, <a href="#">Fuser</a> .

The printed page has a gray background.



Cause	Solution
The priority input tray is not in place.	Adjust the priority input tray.
The print density setting is too high.	Decrease the amount of background shading by using the HP Toolbox.
The media basis-weight is too high.	Change the media to a lower basis-weight.
The humidity level is too low.	Very low humidity can increase the amount of background shading. Move the product to a different location, or decrease the background shading by using the HP Toolbox. If this happens during copying, set the light/dark setting to a light value.
The print cartridge needs to be replaced.	Replace the print cartridge.

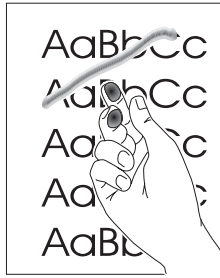
Toner smears appear on the printed page.



Cause	Solution
If the toner smears appear on the leading edge of the media, the media guides are dirty.	Wipe the media guides with a dry, lint-free cloth.
The media does not meet HP specifications (for example, it is too moist or too rough).	Make sure that the media meets specifications detailed in the <i>HP LaserJet Printer Family Print Media Guide</i> .
The print cartridge needs to be replaced.	Replace the print cartridge.
The fuser temperature is too low. The fuser temperature varies according to the type of media being used.	In the <b>Paper</b> tab of the driver, under <b>Type is:</b> , select the appropriate media type from the drop-down list.  If the error persists, replace the ECU. See <a href="#">Engine controller unit</a> .

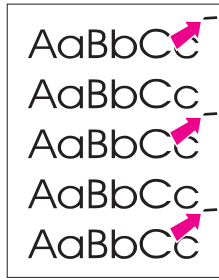


The toner is loose, and it does not stay attached to the printed page.



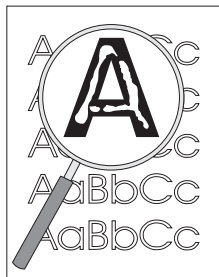
Cause	Solution
The inside of the printer is dirty.	Clean the print path. See, <a href="#">Cleaning the product</a> and <a href="#">Cleaning the print-cartridge area</a> .
The media does not meet HP specifications (for example, it is too moist or too rough).	Make sure that the media meets specifications detailed in the <i>HP LaserJet Printer Family Print Media Guide</i> .
The driver is not set for the correct media.	<ol style="list-style-type: none"> <li>1. On the <b>Paper</b> tab of the printer driver, under <b>Type is:</b>, select the correct media type from the drop-down list.</li> <li>2. Select the correct media by using the HP Toolbox.</li> </ol>
The power strip is not working correctly.	Plug the product directly into an working ac outlet.
The fuser temperature is too low. The fuser temperature varies according to the media type being used.	<p>In the <b>Paper</b> tab of the printer driver, under <b>Type is:</b>, select the correct media type from the drop-down list.</p> <p>If the error persists, replace the ECU. See, <a href="#">Engine controller unit</a>.</p>
The fuser film is torn or has holes.	Replace the fuser. See, <a href="#">Fuser</a> .
The fuser film is damaged.	Check the fuser film for tears or holes. Replace the fuser if necessary. See, <a href="#">Fuser</a> .
The print cartridge needs to be replaced.	Replace the print cartridge.

Repetitive vertical defects appear on the printed page.



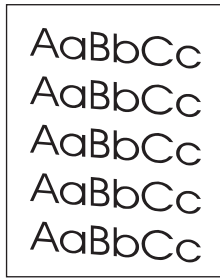
Cause	Solution
If the repetitive mark occurs at equal distance between marks, either the print cartridge or a printer roller is damaged.	Use the defect ruler to identify the spacing. Check the appropriate component and replace if necessary. See <a href="#">Repetitive image defect ruler</a> .
The internal parts have toner on them.	If the defects occur on the back of the page, the problem will probably correct itself after a few more printed pages. Otherwise, clean the printer. See, <a href="#">Cleaning the product</a> and <a href="#">Cleaning the print-cartridge area</a> .
The driver is not set for the correct media.	<ol style="list-style-type: none"> <li>1. In the <b>Paper</b> tab of the printer driver, under <b>Type is:</b>, select the correct media type from the drop-down list. (This affects the current print job only.)</li> <li>2. Select the correct media from the HP Toolbox.</li> </ol>

Characters are poorly formed and are producing hollow images.



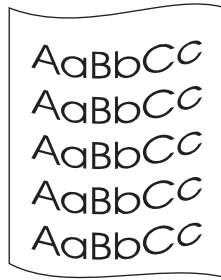
Cause	Solution
The media is too slick.	Try a different media. Make sure that the media meets specifications detailed in the <i>HP LaserJet Printer Family Print Media Guide</i> .
The driver is not set for the correct media.	<ol style="list-style-type: none"> <li>1. In the <b>Paper</b> tab of the printer driver, under <b>Type is:</b>, select the correct media type from the drop-down list. (This affects the current print job only.)</li> <li>2. Select the correct media through HP Toolbox.</li> </ol>

Pages are skewed (crooked).



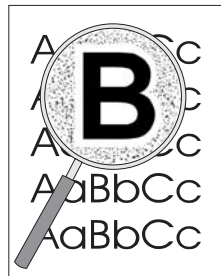
Cause	Solution
The media is loaded incorrectly.	Reload the media, and make sure that the media guides are not too tight or too loose against the media stack. See, <a href="#">Loading media</a> .
The media guides are broken or missing.	Replace the media input tray or the paper-pickup assembly. See, <a href="#">Media input tray</a> or <a href="#">Paper-pickup assembly</a> .
The input tray is too full.	<p>Remove some of the sheets. The HP LaserJet 3015 ADF input tray can hold up to 30 sheets of 75-g/m<sup>2</sup> (20-lb) bond-weight paper (less for heavier paper).</p> <p>Remove some of the sheets. The HP LaserJet 3020 and 3030 ADF input tray can hold up to 50 sheets of 75-g/m<sup>2</sup> (20-lb) bond-weight paper (less for heavier paper).</p> <p>Remove some of the sheets. The HP LaserJet 3015, 3020, and 3030 main input tray can hold up to 150 sheets of 75-g/m<sup>2</sup> (20-lb) bond-weight paper (less for heavier paper).</p>
The type and quality of media does not meet HP specifications.	Make sure that the media meets specifications detailed in the <i>HP LaserJet Printer Family Print Media Guide</i> .

The printed page has curls or waves.



Cause	Solution
Paper curl is inherent to the laser printing process; it occurs when paper is subjected to heat.	Curled paper tends to relax as it cools. Place the paper on a flat surface while it is cooling.
The environment is too warm or too humid.	<ol style="list-style-type: none"> <li>1. Both high temperatures and high humidity levels cause media to curl. Move the product to a different environment.</li> <li>2. Use a different media. Make sure that the media meets specifications detailed in the <i>HP LaserJet Printer Family Print Media Guide</i>.</li> </ol>
The media was in the input tray for too long.	Turn the stack of media over and put it back in the tray. Rotate the media 180° and put it back in the tray.
The fuser temperature is too high. The fuser temperature varies according to the type of media being used.	Select a lighter-weight media type from the printer driver or the HP Toolbox.

Large amounts of toner are scattered around the characters.



Cause	Solution
The media resistivity is too high.	<ol style="list-style-type: none"> <li>1. Use a different media. Make sure that the media meets specifications detailed in the <i>HP LaserJet Printer Family Print Media Guide</i>.</li> <li>2. Turn the stack of media over and put it back in the tray.</li> <li>3. Use media that is designed for laser printers.</li> </ol>

Vertical white stripes appear.



Cause	Solution
The media does not meet HP specifications (for example, it is too moist or too rough).	Make sure that the media meets specifications detailed in the <i>HP LaserJet Printer Family Print Media Guide</i> .
The toner is low.	Gently shake the print cartridge back and forth to redistribute the toner.

## Solving scanning (copying) image-quality problems

Use the following tables to help solve problems with scanned or copied pages.

---

### Note

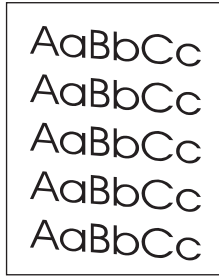
---

Some image-quality problems can be isolated by performing printer functional tests. See [Functional checks](#). Image quality problems can also be caused by using cables that are not IEEE-1284 compliant.

### Pages do not print.

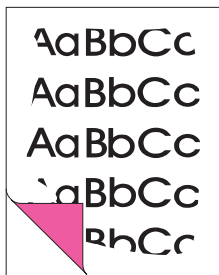
Cause	Solution
The product is not plugged in, or the power switch is not on.	Make sure that the product is plugged into a working wall outlet or power strip and that the power switch is turned on.
The computer cable is loose.	Check that the cable between the product and the computer is securely connected.
The tape was not removed from the print cartridge.	Remove the print cartridge, remove the tape, and reinstall the print cartridge.
The print cartridge is out of toner.	Replace the print cartridge.
The media does not meet HP specifications (for example, it is too moist or too rough).	Make sure that the media meets specifications detailed in the <i>HP LaserJet Printer Family Print Media Guide</i> .
The original was loaded upside-down.	Load the original with the side to be scanned facing down in the ADF for the HP LaserJet 3015, or up in the ADF for the LaserJet 3020 and 3030. Load the original with the side to be scanned facing down on the flatbed (HP LaserJet 3020 and 3030).

Pages are skewed (crooked).



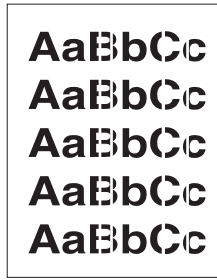
Cause	Solution
The media is loaded incorrectly.	Reload the media, and make sure that the media guides are not too tight or too loose against the media stack. See <a href="#">Loading media</a> .
The media guides are broken or missing.	Replace the media input tray or the paper-pickup unit. See <a href="#">Media input tray</a> or <a href="#">Paper-pickup assembly</a> .
The ADF input tray is too full.	Remove some of the sheets. The HP LaserJet 3015 ADF input tray can hold up to 30 sheets of 75-g/m <sup>2</sup> (20-lb) bond-weight paper. Remove some of the sheets. The HP LaserJet 3020 and 3030 ADF input tray can hold up to 50 sheets of 75-g/m <sup>2</sup> (20-lb) bond-weight paper. Remove some of the sheets. The HP LaserJet 3015, 3020, and 3030 main input tray can hold up to 150 sheets of 75-g/m <sup>2</sup> (20-lb) bond-weight paper.
The type and quality of media does not meet HP specifications.	Make sure that the media meets specifications detailed in the <i>HP LaserJet Printer Family Print Media Guide</i> .

Parts of the page around the edges are not printing.



Cause	Solution
The product cannot print to the edge of the paper. The printer has minimum margins on each edge of 6 mm (0.25 inch).	To fit the image into this printable area, slightly reduce the size of the image.
If copying, the reduction setting is incorrect.	Copied images will be clipped if the image on the original is too close to the edge of the original.
The paper size setting is incorrect.	Set the correct page size on the control-panel menu.

Vertical white stripes appear.



Cause	Solution
The media does not meet HP specifications (for example, it is too moist or too rough).	Make sure that the media meets specifications detailed in the <i>HP LaserJet Printer Family Print Media Guide</i> .
The toner is low.	Gently shake the print cartridge back and forth to redistribute the toner.
If copying with the ADF, the ADF glass is dirty.	<ol style="list-style-type: none"> <li>1. Clean the ADF glass. See <a href="#">Cleaning the product</a>.</li> <li>2. If the problem persists, replace the print cartridge.</li> <li>3. If the problem persists, replace the fuser assembly. See, <a href="#">Fuser</a>.</li> </ol>

Copies or scanned images are too light or too dark.



Cause	Solution
The contrast is not set correctly.	<ol style="list-style-type: none"> <li>1. Adjust the contrast and resolution settings on the control-panel menu (see, <a href="#">Control-panel menu structure</a>) or from the HP Toolbox.</li> <li>2. Check that the contrast and resolution settings are correct. See the user guide for more information.</li> </ol>
The original image is very light or very dark.	Adjust the resolution and contrast setting(s) on the control-panel menu (see, <a href="#">Control-panel menu structure</a> ) or from the HP Toolbox.
The scanned image is too light or too dark because the original was on colored paper.	If the original was on a colored paper, including brown recycled paper, the text might not be clear. Adjust the resolution, contrast, and brightness settings from HP Toolbox.

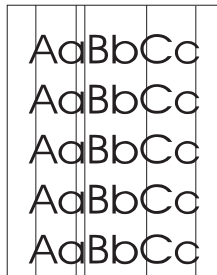


The printed page has a gray background.



Cause	Solution
The priority input tray is not in place.	Adjust the priority input tray.
The print density setting is too high.	Decrease the amount of background shading by using the HP Toolbox.
The lighter/darker setting is incorrect. Some "white" media might produce a greyish background at the default lighter/darker settings.	Adjust the lighter/darker setting to a lighter level.
The media basis-weight is too high.	Change the media to a lower basis-weight.
The humidity level is too low.	Very low humidity can increase the amount of background shading. Move the product to a different location, or decrease the background shading by using the HP Toolbox.
The print cartridge needs to be replaced.	Replace the print cartridge.

Vertically-aligned black streaks or smears appear on successive pages.



Cause	Solution
The ADF glass is dirty. See, <a href="#">Cleaning the product</a> .	Try copying from the flatbed scanner (HP LaserJet 3020 and 3030 only). If the problem occurs only with the ADF, clean the ADF glass. See, <a href="#">Cleaning the product</a> .
The printer needs to be cleaned.	If the problem occurs when copying from the flatbed scanner and the ADF, clean the printer. See, <a href="#">Cleaning the product</a> .
A component is damaged. (For example, the photosensitive drum inside the print cartridge is scratched.)	<ol style="list-style-type: none"> <li>1. Replace the print cartridge if it is damaged and if maintenance procedures do not improve print quality.</li> <li>2. Replace the scanner assembly. <b>HP LaserJet 3015:</b> see, <a href="#">Scanner assembly</a>. <b>HP LaserJet 3020 and 3030:</b> <a href="#">Scanner assembly</a>.</li> </ol>

Scanned images have black dots or streaks.



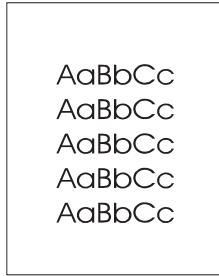
Cause	Solution
The scanner glass is dirty.	Clean the ADF path and flatbed glass. See, <a href="#">Cleaning the product</a> .
The toner drum in the print cartridge is damaged.	Replace the print cartridge.
A problem exists with the scanner assembly.	Replace the scanner assembly. <b>HP LaserJet 3015:</b> see, <a href="#">Scanner assembly</a> . <b>HP LaserJet 3020 and 3030:</b> <a href="#">Scanner assembly</a> .

Scanned text is not clear.



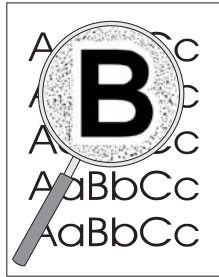
Cause	Solution
The contrast, resolution, or brightness needs to be adjusted before scanning.	<ol style="list-style-type: none"> <li>Adjust the contrast and resolution settings from the HP Toolbox.</li> <li>Check that the contrast and resolution settings are correct. See the user guide section for more information.</li> </ol>
The original is on colored paper.	If the original is on colored paper, including brown recycled paper, the text might not be clear. Try adjusting the resolution, contrast, and brightness settings from the HP Toolbox.
There is a problem with the scanner assembly.	Replace the scanner assembly. <b>HP LaserJet 3015:</b> see, <a href="#">Scanner assembly</a> . <b>HP LaserJet 3020 and 3030:</b> <a href="#">Scanner assembly</a> .

Images are scanning at a reduced size.



Cause	Solution
The HP software settings are set to reduce the scanned image.	<ol style="list-style-type: none"><li data-bbox="932 499 1410 527">1. Adjust the settings from the HP Toolbox.</li><li data-bbox="932 541 1445 596">2. Adjust the settings in the HP LaserJet Scan software.</li></ol>

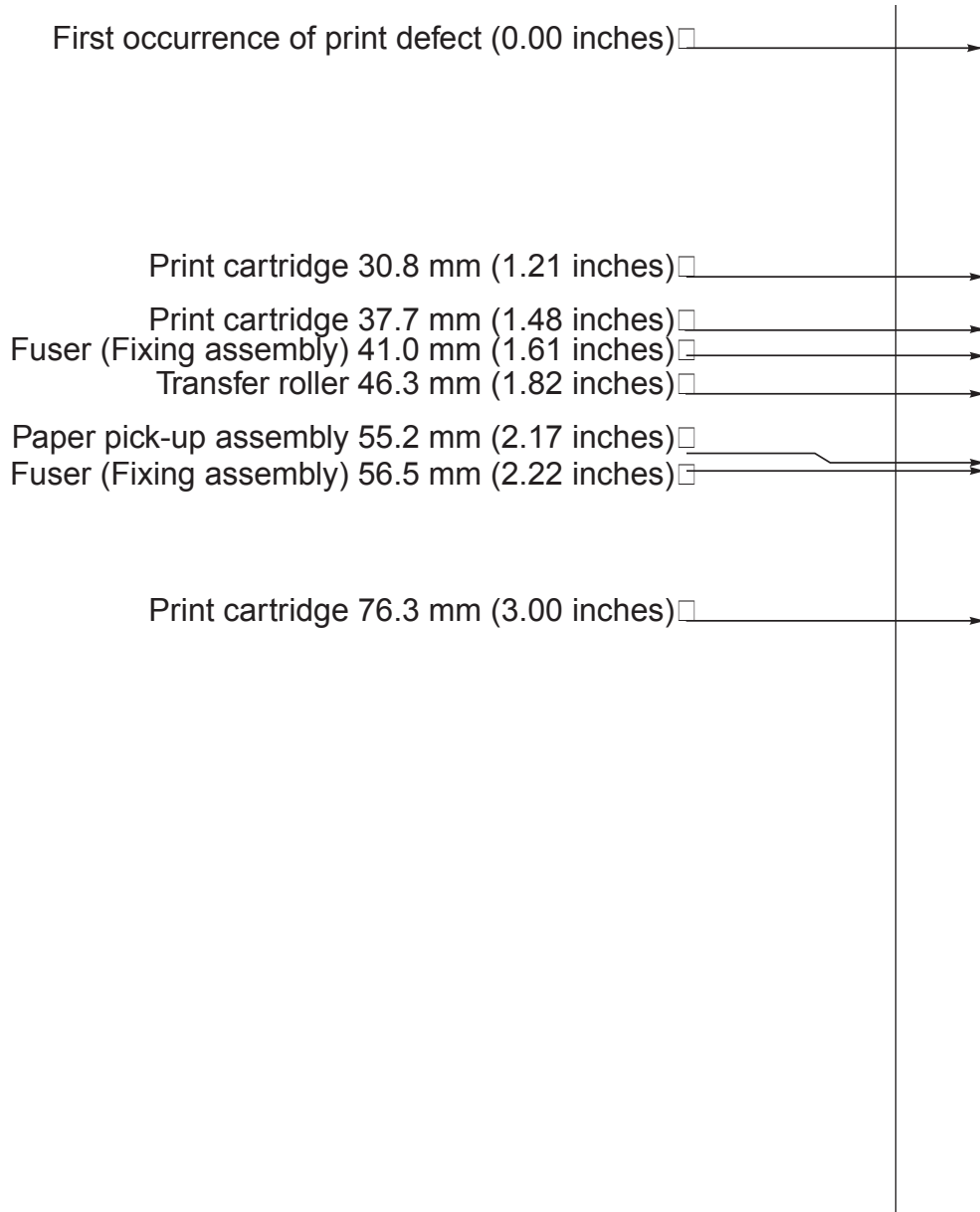
Large amounts of toner are scattered around the characters.



Cause	Solution
The media resistivity is too high.	<ol style="list-style-type: none"><li data-bbox="932 1079 1465 1163">1. Use a different media type. Make sure that the media meets specifications detailed in the <i>HP LaserJet Printer Family Print Media Guide</i>.</li><li data-bbox="932 1178 1465 1241">2. Turn the stack of media over and put it back in the tray.</li><li data-bbox="932 1255 1465 1283">3. Use media that is designed for laser printers.</li></ol>

## Repetitive image defect ruler

Use the repetitive image-defect ruler to help solve image quality problems. Place the top line on the ruler next to the first occurrence of the defect on the page. Find the mark that points to the next instance of the defect to identify the component that is causing the defect.



**Figure 6-1.** Repetitive image defect ruler

**Note**

The repetitive image defect ruler is for reference only and may not display or print to exact scale. Use a measuring device to determine the spacing between repeating image defects.

## Solving paper-feed problems

Use the information in this section to solve problems that are related to moving paper or documents through the product.

---

### CAUTION

---

Always try to remove a jam in the direction that the media feeds through the printer.

If the problem occurs when copying or scanning, see [Solving scanning \(copying\) image-quality problems](#).

### Jams occur in the printer

Occasionally, media becomes jammed during a print job. Try the following remedies before you attempt to clear the jam:

- Make sure that the media meets specifications.
- Make sure that the media is not wrinkled, folded, or damaged.
- Make sure that the product is clean. See [Cleaning the product](#).
- Make sure that the input trays are loaded properly and are not too full. See, [Loading media](#).

### To clear a jam

---

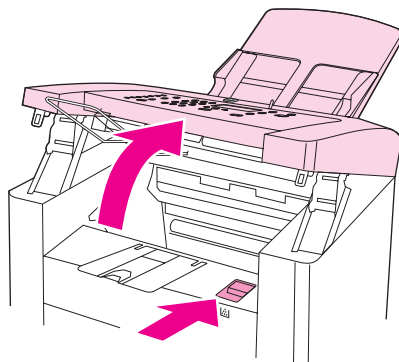
### CAUTION

---

Jams might result in loose toner on the page. If toner falls on clothing, wash it in cold water. Hot water will permanently set the toner into the fabric. If toner is on your hands, wash them in cold water.

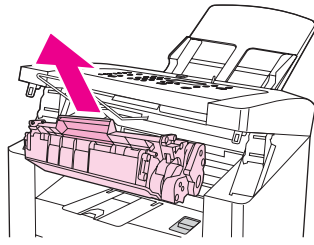
*Never* use a sharp object, such as a pencil or scissors, to remove jammed media.

1. Open the print-cartridge door .



**Figure 6-2.** Clear a jam in the product base (1 of 3)

2. Grasp the handle on the print cartridge, remove the print cartridge, and set it aside.



**Figure 6-3.** Clear a jam in the product base (2 of 3)

---

**CAUTION**

---

To prevent damage to the print cartridge, do not expose it to light any longer than necessary. Place the print cartridge in a paper bag or other opaque container until you can place it back in the device.

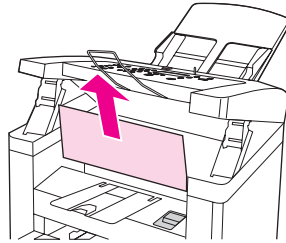
3. With both hands, grasp the side of the media that is most visible (this includes the middle), and carefully pull it free from the product.

---

**Note**

---

Always try to remove a jam towards the way it would move through the paper path.



**Figure 6-4.** Clear a jam in the product base (3 of 3)

4. After the jammed media is removed, replace the print cartridge, and close the print-cartridge door.
5. After clearing a jam, turn off the product, and then turn it on again.

### To clear other media jams

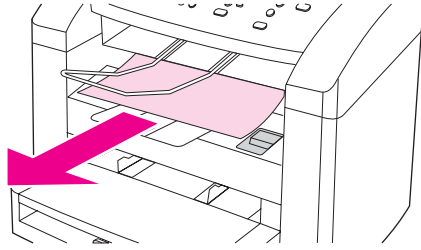
---

**CAUTION**

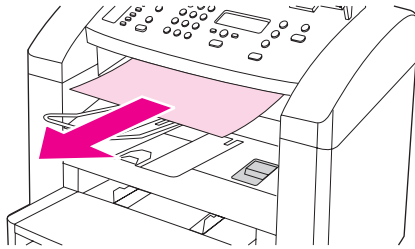
---

*Never* use a sharp object, such as a pencil or scissors, to remove jammed media.

If the media has jammed where it exits the product, grasp the leading edge of the media and pull the media out through the output bin.



**Figure 6-5.** Clearing output bin jams (HP LJ 3015)



**Figure 6-6.** Clearing ADF output bin jams (HP LaserJet 3015)



**Figure 6-7.** Clearing output bin jams (HP LaserJet 3020 and 3030)

If the media has jammed in the automatic document feeder (ADF), see [Jams occur in the automatic document feeder \(ADF\)](#).

---

**Note**

---

If you turned the product off before clearing the jam, turn it on again, and then resend the printing or copying job.

## Solving print paper-feed problems

Use the following tables to solve paper-feed problems when printing.

Pages are coming out curled or wrinkled.

Cause	Solution
Paper curl is inherent to the laser printing processes, and occurs when paper is subjected to heat. Paper curl tends to relax as the paper cools while resting on a flat surface.	Make sure that the media meets specifications detailed in the <i>HP LaserJet Printer Family Print Media Guide</i> . Remove the media, turn it over, and reload it.
Paper is curled or wrinkled when printing.	In the printer driver, on the <b>Paper</b> or <b>Paper/Quality</b> tab, select a lighter-weight media type, such as <b>Light &lt;75 g/m2</b> , to reduce the fuser temperature.
Paper is curled when faxing or copying.	Try an alternate media.
Paper is not stored properly.	Whenever possible, store paper in its sealed ream at room temperature.
The media is too long for the printer output bin.	Use the long media extension.

Print is misaligned on the page (skewed pages).

Cause	Solution
The media input tray is overfilled.	Remove some of the media.
The paper guides are not set correctly, are broken, or are missing.	Be sure to center the paper with the side media guides. Verify that the guides are not adjusted too tightly or too loosely against the paper. Check for broken or missing guides and replace as necessary.
The paper weight or surface finish does not meet HP specifications.	Make sure that the media meets specifications detailed in the <i>HP LaserJet Printer Family Print Media Guide</i> .



The printer feeds multiple sheets or jams frequently from the main input tray or priority input tray.

Cause	Solution
Paper guides are not adjusted properly.	Slide the guides against the sides of the stack in the media input tray or the priority input tray to center the paper. Make sure the guides are not adjusted too tightly.
Paper was not removed from the main input tray before refilling the tray.	Always remove paper from the main input tray before refilling it.
The main input tray or priority input tray is overfilled.	<p>Remove some of the sheets. The HP LaserJet 3015 ADF input tray can hold up to 30 sheets of 60-g/m<sup>2</sup> (16-lb) bond-weight paper.</p> <p>Remove some of the sheets. The HP LaserJet 3020 and 3030 ADF input tray can hold up to 50 sheets of 60-g/m<sup>2</sup> (16-lb) bond-weight paper.</p> <p>Remove some of the sheets. The HP LaserJet 3015, 3020, and 3030 main input tray can hold up to 150 sheets of 60-g/m<sup>2</sup> (16-lb) bond-weight paper.</p>
The paper was poorly cut by the manufacturer and is sticking together.	“Break” the ream of paper by curving it into an upside-down u-shape; this can effectively decrease multifeeds. Also try turning the paper around to feed the opposite end first, or use a different type of paper.
The paper does not meet HP specifications for print media.	Make sure that the media meets specifications detailed in the <i>HP LaserJet Printer Family Print Media Guide</i> .
The output capacity was exceeded in the paper output bin.	Do not allow more than 125 sheets of 75 g/m <sup>2</sup> (20-lb) bond-weight paper (less for heavier paper) to fill the paper output bin.
The pickup roller is dirty or damaged.	<p>Clean the pickup roller.</p> <p>Replace the pickup roller. See, <a href="#">User replaceable parts</a>.</p>
The separation pad is dirty or damaged.	<p>Clean the separation pad.</p> <p>Replace the separation pad. See, <a href="#">User replaceable parts</a>.</p>
A sensor is not operating properly.	Check the sensors to make sure that none is jammed. If a sensor cannot be corrected, replace the sensor.

## Jams occur in the automatic document feeder (ADF)

Occasionally, media becomes jammed during a copy, scan, or fax job.

You are notified of a media jam by a software error message and the **Doc feeder jam Clear, Reload** message that appears on the device control-panel display.

## To clear a media jam from the automatic document feeder (ADF)

1. Remove the ADF input tray and open the ADF lid.

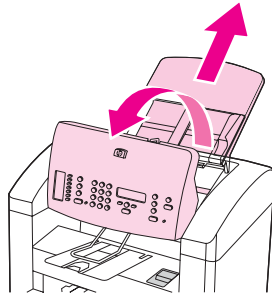


Figure 6-8.

ADF lid open (HP LaserJet 3015)

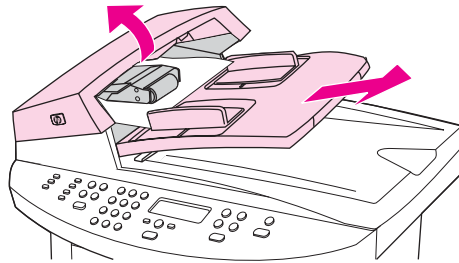
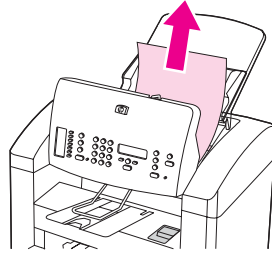


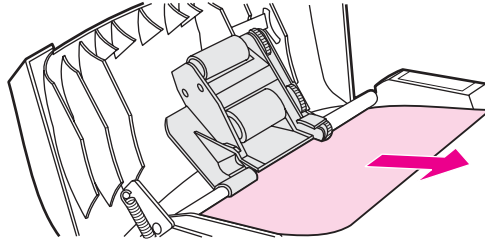
Figure 6-9.

ADF lid open (HP LaserJet 3020 and 3030)

- Carefully remove jammed media (for the HP LaserJet 3020 and 3030: lifting the green lever, rotate the pickup roller assembly until it stays open). Gently try to remove the page without tearing it.



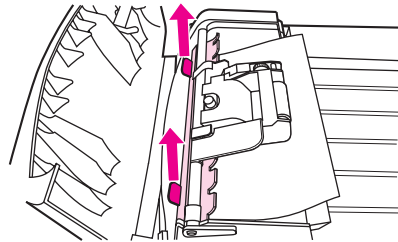
**Figure 6-10.** Clear an ADF jam (HP LaserJet 3015)



**Figure 6-11.** Clear an ADF jam (HP LaserJet 3020 and 3030; 1 of 2)

**Note**

When removing media jammed in the ADF, it might be helpful to remove the ADF guide/cleanout comb.



**Figure 6-12.** Clear an ADF jam (HP LaserJet 3020 and 3030; 2 of 2)

- Close the ADF lid and replace the ADF input tray.

## Solving scanner (copier) paper-feed problems

Use the following tables to help solve paper-feed problems when scanning or copying.

**Long pages stop feeding through the ADF.**

Cause	Solution
The document is too long.	The maximum document length is 381 mm (15 inches). If the document is too long, copy segments of it and scan each copy.
The paper delivery sensor is damaged.	Check the paper delivery sensor to make sure it is not jammed. If the sensor cannot be corrected, replace it.

Scanned items are crooked.

Cause	Solution
The media input tray guides are not set correctly, are broken, or are missing.	Be sure to center the paper with the media input tray guides. Verify that the guides are not adjusted too tightly or too loosely against the paper. Check for broken or missing guides and replace as necessary.

Pages refeed into the ADF.

Cause	Solution
The media is damaged. Make sure that the media is flat (not folded) and that it meets weight specifications.	Make sure that the media is not folded or torn, and that it meets specifications detailed in the <i>HP LaserJet Printer Family Print Media Guide</i> .

The ADF feeds multiple sheets or jams frequently from the media input tray.

Cause	Solution
The media input tray guides are not adjusted properly.	Remove the document from the media input tray. Straighten the item, then reinsert it. Slide the guides against the sides of the item to center it. Make sure that the guides are not adjusted too tightly.
The media input tray is overfilled.	Remove some of the sheets. The media input tray can hold up to 30 (HP LaserJet 3015) or 50 (HP LaserJet 3020 and 3030) pages, depending on the thickness of the pages.
The item was too thick, too slick, or otherwise did not meet specifications.	Make sure that the media meets specifications detailed in the <i>HP LaserJet Printer Family Print Media Guide</i> Use the flatbed ( HP LaserJet 3020 and 3030) to make the scan or copy.
The ADF pickup roller is dirty or worn.	Clean or replace the ADF pickup roller. See,
The ADF document feed guide is not installed properly.	Ensure that both sides of the ADF document feed guide are snapped in properly.
The ADF pickup roller is damaged or worn.	<b>HP LaserJet 3015:</b> replace the scanner assembly. See, <a href="#">Scanner assembly</a> . <b>HP LaserJet 3020 and 3030:</b> replace the ADF pickup roller See, <a href="#">User replaceable parts</a> .
The ADF separation pad is dirty, damaged, or worn.	Replace the ADF separation pad. See, <a href="#">User replaceable parts</a> .
The sensor is not operating properly.	Check the sensor to make sure it is not jammed. If a sensor cannot be corrected, replace the ADF assembly.
A problem exists in the ADF path.	Check the path for obstructions. Readjust as necessary or replace the ADF assembly (the ADF assembly is part of the flatbed lid for the HP LaserJet 3020 and 3030). See, <a href="#">Scanner assembly</a> or <a href="#">Flatbed lid</a> .

# Solving problems with digital subscriber line (DSL) connections

---

## Note

The HP LaserJet 3015 and 3030 all-in-one products have faxing capability. The HP LaserJet 3020 all-in-one product *does not* operate as a faxing device.

A digital subscriber line (DSL) uses digital technology over standard copper phone wires. DSL services rely on an AM radio wave that has a range of 600 kHz to 2.2 GHz. The HP LaserJet 3015 and 3030 all-in-one is a Group 3 fax device, which operates at about 200 kHz (below the DSL capability) and is not directly compatible with digital signals. However, if specified during the DSL line setup, the signal on a DSL line can be separated so that some of the bandwidth is used to transmit an analog signal (for voice and fax) while the remaining bandwidth is used to transmit digital data. Split the signal to use both the telephone or fax and the computer on the same line and at the same time.

---

## Note

Not all printers and faxes are compatible with DSL services. HP does not guarantee that the HP LaserJet all-in-one product will be compatible with all DSL service lines or providers.

The DSL modem requires a high-pass filter. Sometimes when DSL service is installed, the service provider supplies a splitter, which includes a low-pass filter, for the normal house phone wiring. If not, the user should contact the DSL provider, and request a filter or splitter to enable a fax modem to operate on the line.

---

## Note

HP recommends discussing DSL line setup options with the DSL service provider. Consult the DSL provider for technical installation requirements.

## Connecting additional devices

Depending on how the phone lines are set up, additional devices can be connected to the phone line along with the HP LaserJet 3015 and 3030 all-in-one. In general, no more than three or four devices should be connected to a single phone line. If too many devices are connected to a single phone line, one or more of the devices might not detect an incoming call. If this occurs, disconnect one or more of the devices.

---

## Note

This product cannot replace a computer modem. It cannot act as a modem for sending and receiving e-mail, for connecting to the Internet, or for communicating with other computers.

## Dedicated fax line

If the product is connected to a phone line that is used only for fax calls, the following devices can be connected:

- Caller ID box
- Modem—An internal or external computer modem can be connected to the fax line if the fax line is to be used for e-mail or access to the Internet. However, faxes might not be sent or received while the line is being used for these purposes.
- Extra phone—An extra phone line can be connected to the fax line if the fax is to be used for making outgoing calls.

Do *not* connect an answering machine or computer voicemail system to the fax line. If the customer uses computer voicemail, connect the external or internal modem to the dedicated phone line. Then, use the dedicated voice line to connect to the Internet and receive voicemail.

## Shared phone line

If the product is connected to a phone line that is shared between fax calls and voice calls, or if the phone line has two phone numbers assigned and uses a ring-pattern service, the following devices can be connected:

- Caller ID box
- Modem—An internal or external computer modem can be connected to the fax line if the fax line is to be used for e-mail or access to the Internet. However, faxes might not be sent or received while the line is being used for these purposes.
- Phone—Connect a phone to the shared phone line to make or answer voice calls on the shared line.
- Answering machine or computer voicemail system—Connect these devices to the same phone jack that the product uses in order to make sure that the different devices do not interfere with one another.

---

### Note

It is possible to connect devices to another phone jack for the same phone line (for example, in another room). However, the devices might interfere with faxing and with each other.

## To connect additional devices to the HP LaserJet 3015 all-in-one and the HP LaserJet 3030 all-in-one

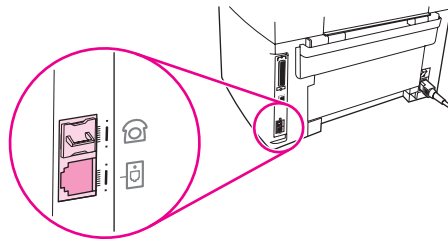
Connect additional devices in the order that is described in the following steps. The output port for each device is connected to the input port of the next, forming a "chain". If you do not want to connect a specified device, skip the step that explains it and continue to the next device.

---

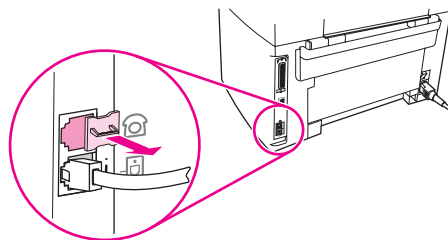
### Note

Do not connect more than three devices to the telephone line.

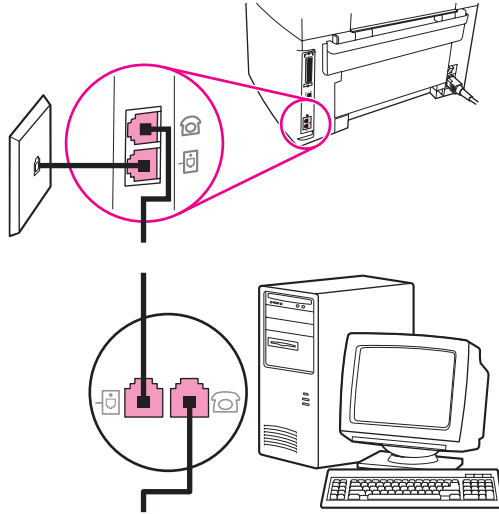
1. Unplug the power cords for all the devices that you want to connect.
2. The device should already be connected to a telephone jack.
3. Locate the fax ports on the back of the device.



4. Remove the plastic insert from the "telephone" port (the port that is marked with a telephone icon).



5. To connect an internal or external modem on a computer, plug one end of a telephone cord into the device “telephone” port (the port that is marked with a telephone icon). Plug the other end of the cord into the modem “line” port.



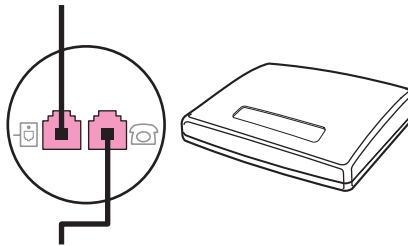
---

**Note**

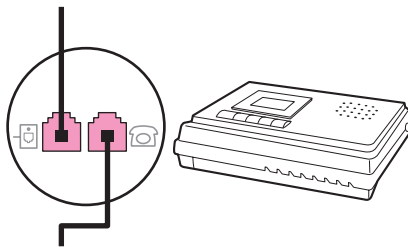
---

Some modems have a second “line” port to connect to a dedicated voice line. If you have two “line” ports, see your modem documentation to make sure that you connect to the correct “line” port.

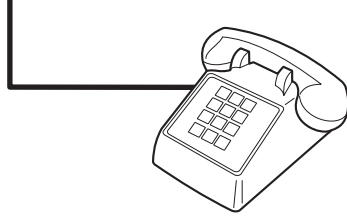
6. To connect a caller-ID box, plug a telephone cord into the previous device’s “telephone” port. Plug the other end of the telephone cord into the caller-ID box “line” port.



7. To connect an answering machine, plug a telephone cord into the previous device’s “telephone” port. Plug the other end of the telephone cord into the answering machine “line” port.



8. To connect a telephone, plug a telephone cord into the previous device's "telephone" port. Plug the other end of the telephone cord into the telephone "line" port.



9. After you have finished connecting additional devices, plug all of the devices into their power sources.



## Functional checks

Use the following procedures to help diagnose and solve problems that occur in the print engine.

### Control-panel test

---

#### Note

Perform this procedure as quickly as possible in order to complete the control-panel check before the formatter begins communicating with the control panel. The control-panel test continues until all of the buttons have been tested or until the formatter attempts to communicate with the control panel (after approximately 40 seconds). The control-panel test will be interrupted if it is not completed before communication occurs.

1. Turn the product power on by using the power switch.
2. Immediately press the **>** and **CANCEL** buttons simultaneously.
3. Press and hold down the **>** and **CANCEL** buttons until the message **Passed MEM Test** appears on the control-panel display.
4. Release the **>** and **CANCEL** buttons.
5. Press the **MENU/ENTER** button to test the control-panel display LEDs. Continue to press **MENU/ENTER** until the message **Scroll Check--Press Enter To Pass** appears on the control-panel display.
6. Press **MENU/ENTER** again.
7. The name of a control-panel button will appear on the control-panel display. Press the corresponding button on the control panel. Repeat this step until all of the control-panel buttons have been tested.

---

#### Note

The control-panel test continues until all of the buttons have been tested or there is no activity at the control panel for about 20 seconds. After testing all of the control-panel buttons (or when there is no activity at the control panel for about 20 seconds), the product exits the test and continues the startup processes.

### Half self-test functional check

The purpose of the half self-test check is to determine which image-formation process is malfunctioning. The image-formation process can be subdivided into the following stages:

- conditioning stage (charges the drum)
- writing stage (writes a latent image to the drum with the laser)
- development stage (forms a toner image on the drum)
- transfer stage (transfers the image to paper)
- separation stage (separates the media from the drum)
- fusing stage (applies heat and pressure to make the image on paper permanent)
- cleaning stage (removes excess toner from the drum)

### To perform a half self-test check

1. Print a self-test page. (See [Troubleshooting tools](#).)

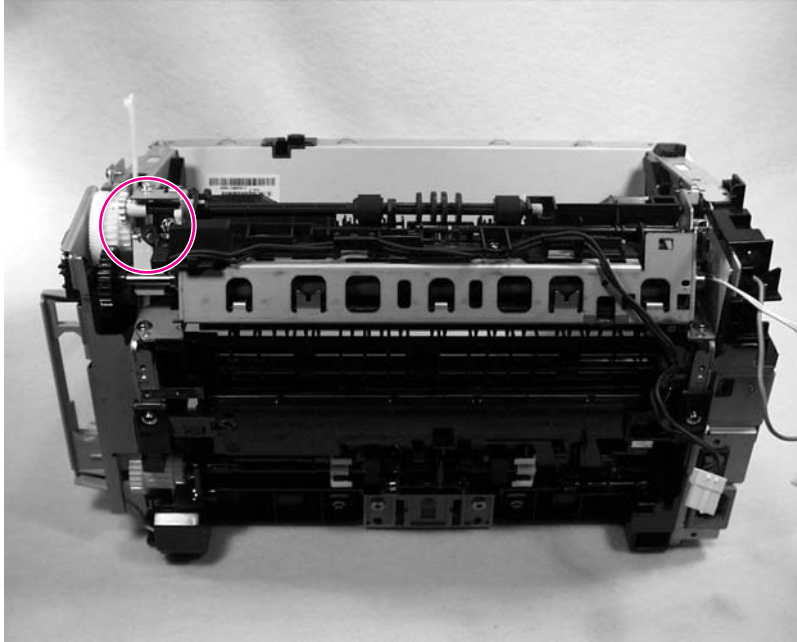
2. Open the print cartridge door after the paper advances halfway through the printer (about 5 seconds after the motor begins rotation). The leading edge of the paper should have advanced past the print cartridge.
3. Remove the print cartridge.
4. Open the print cartridge drum shield to view the drum surface. If a dark and distinct toner image is present on the drum surface, assume that the first three functions of the image-formation process are functioning (through the development stage). Troubleshoot the failure as a transfer or fusing problem.

### **To perform other checks**

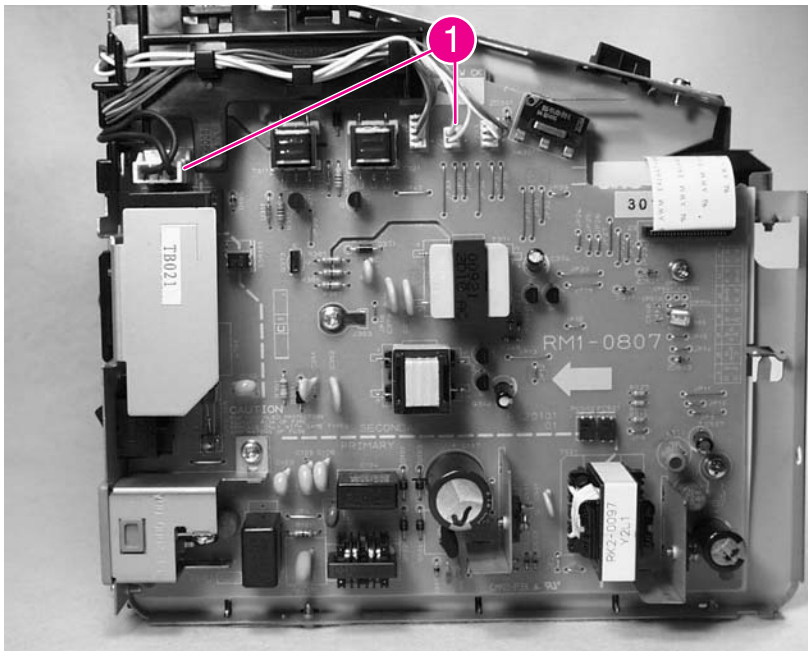
If, during the half self-test check, no image is present on the photosensitive drum, perform these checks:

1. Make sure that you removed the entire length of the sealing tape from the print cartridge before you installed the cartridge.
2. Perform a drum-rotation functional check. (See [Drum rotation functional check](#).)
3. Perform a high-voltage power-supply check. (See [High-voltage contacts check](#).)

If a transfer problem, replace the transfer roller. If a fuser problem, first make sure to check the two wire-harness connectors (J102 and J204; callout 1) on the power supply.



**Figure 6-13.** Check the fuser connectors on the fuser



**Figure 6-14.** Check the fuser connectors on the power supply

## Drum rotation functional check

The photosensitive drum, located in the print cartridge, must rotate in order for the print process to work. The photosensitive drum receives its drive from the main drive assembly.

---

### Note

This test is especially important if refilled print cartridges have been used.

1. Open the print-cartridge door.

2. Remove the print cartridge.
3. Mark the drive gear on the cartridge with a felt-tipped marker. Note the position of the mark.
4. Install the print cartridge and close the print-cartridge door. The startup sequence should rotate the drum enough to move the mark.
5. Open the print-cartridge door and inspect the gear that was marked in step 3. Verify that the mark moved.

If the mark did not move, inspect the main drive assembly to make sure that it is meshing with the print-cartridge gears. If the drive gears appear functional and the drum does not move, replace the print cartridge.

## High-voltage contacts check

The high-voltage contacts in the product must have a good connection with the contacts on the print cartridge to provide the necessary voltages for the image-formation processes.

### To check the print-cartridge contacts

Remove the print cartridge and visually inspect the three connection points (callout 1) on the end of the print cartridge. If they are dirty or corroded, clean the connection. If they are damaged, replace the print cartridge.

---

**Note**

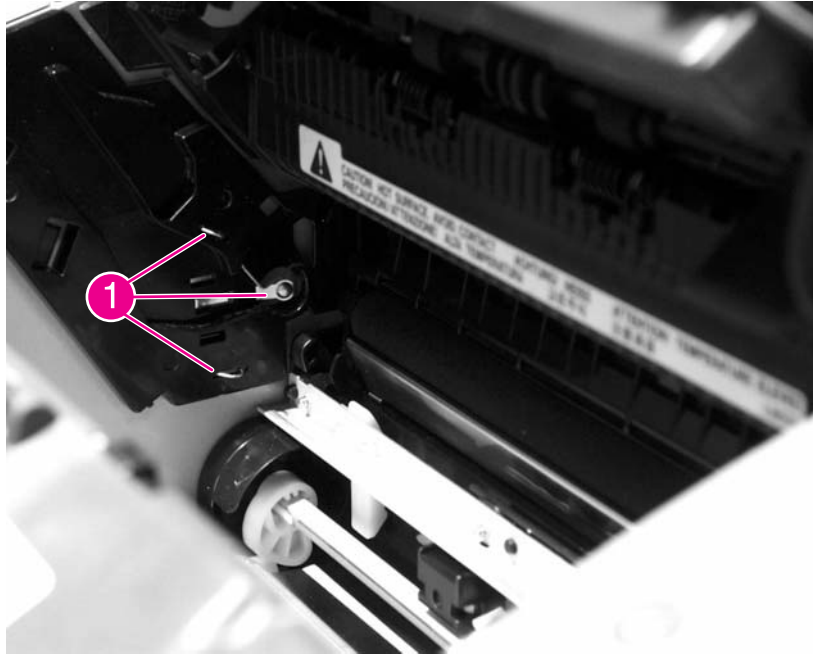
Use only isopropyl alcohol to clean the connections.



**Figure 6-15.** Print-cartridge high-voltage contacts

## To check the high-voltage connector pins

The assembly has three spring-loaded pins (callout 1) to contact the print cartridge. Verify that the pins are not dirty or corroded and that the spring-loading action is functional. If the pins are dirty or obstructed, clean them using a dry cloth. If they are damaged, replace the product.



**Figure 6-16.** High-voltage contacts

## Updating the firmware code

---

**Note**

If after attempting to update the firmware code the device does not return to the **Ready** state, perform the following procedures.

Try the firmware update again.

Perform the NVRAM init procedure. See [NVRAM init](#).

If the device still does not reach the **Ready** state, replace the formatter. See [Formatter and line interface unit \(LIU\)](#).

---

The device uses a flash-memory-based formatter that enables the firmware code to be updated when updated firmware is available. Flash memory also provides a method for product recovery if the installed firmware becomes corrupted or fails.

Print a configuration page to find out what version of firmware code is installed on the device. If updated firmware is available, download the appropriate update ([www.hp.com/support/lj3015](http://www.hp.com/support/lj3015); [www.hp.com/support/lj3020](http://www.hp.com/support/lj3020); [www.hp.com/support/lj3030](http://www.hp.com/support/lj3030)) and follow the instructions in the ReadMe file.

## Troubleshooting tools

Use the control panel to print configuration reports and demonstration pages. The configuration report shows the settings that have been selected from the control panel. Printing a configuration report is also considered a "self test" for the printer, although any of the reports can serve this purpose. A printout of the control-panel menu structure is a useful reference if you alter settings in the menu.

### Printing a configuration report, demonstration page, or menu structure

1. Press **MENU/ENTER**.
2. Use the **<** or **>** button to select **Reports** and then press **MENU/ENTER**.
3. Use the **<** or **>** button to select either **Config report** , **Demo Page** , or **Menu Structure** and then press **MENU/ENTER**. The product exits the Menu settings and prints the report.

### Printing all fax reports at once (HP LaserJet 3015 and 3030 only)

To print all fax reports at once:

1. Press **MENU/ENTER**.
2. Use the **<** or **>** button to select **Reports** and then press **MENU/ENTER**.
3. Use the **<** or **>** button to select **All fax reports** and then press **MENU/ENTER**. The product exits the Menu settings and prints the reports.

When you print all reports at once, the following reports are printed:

- Fax activity log—recent faxes sent and received, and their status
- Billing log (if enabled)—sorted by billing code
- Block fax list (if enabled)—fax numbers you have blocked
- Configuration report—current control-panel settings, including the following sections:
  - System information
  - Reports
  - Fax settings
  - User defaults
  - Service
  - Page counts
- Speed-dial report—one-touch, speed-dial, and group-dial report
- Usage page

### T.30 protocol trace (HP LaserJet 3015 and 3030 only)

Use a T.30 protocol trace report to troubleshoot fax transmission and receive issues.

## To print a T.30 protocol trace report

1. Press **MENU/ENTER**.
2. Use the **<** or **>** button to select **Service** and then press **MENU/ENTER**.
3. Use the **<** or **>** button to select **Print T.30 trace** and then press **MENU/ENTER**.
4. Use the **<** or **>** button to select **Now**, and then press **MENU/ENTER**. The product exits the Menu settings and prints the reports.

Send a fax from the product or receive a fax to the product from another fax machine. Print a T.30 trace report after the fax prints.

Explanations of some of the report column heading follow:

- **Date and Time** identify when the fax begins. Match this information with the fax log of errors.
- **Type** is the type of fax activity: send or receive.
- **Identification** is the phone number to which a fax is sent.
- **Result** explains the status of the fax:
  - “OK” means that the fax was successful.
  - “Pending” faxes are in memory or are printing.
  - For error codes and their meanings, see [Table 6-4. Fax receive codes](#) and [Table 6-5. Fax send codes](#).

## Fax error-correction mode (ECM) (HP LaserJet 3015 and 3030 only)

Normally, the product monitors the signals on the telephone line while it is sending or receiving a fax. If the product detects an error during the transmission and the error-correction mode is **On**, the product can request that the portion of the fax be resent. The factory-set default for error-correction mode is **On**.

## To change the error-correction setting

1. Press **MENU/ENTER**.
2. Use the **<** or **>** button to select **Fax setup**, and then press **MENU/ENTER**.
3. Use the **<** or **>** button to select **All faxes**, and then press **MENU/ENTER**.
4. Use the **<** or **>** button to select **Error correction**, and then press **MENU/ENTER**.
5. Use the **<** or **>** button to select **On** or **Off**, and then press **MENU/ENTER** to save the selection.

## V.34 fax standard

V.34 is the industry-wide fax standard for full-duplex modems that transmit at speeds up to 28,000 bps. When V.34 is turned on, the product automatically adjusts the transmission speed based on the clarity of the image. Turning V.34 off can resolve some fax transmission issues.

## To change the V.34 setting

1. Press **MENU/ENTER**.
2. Use the **<** or **>** button to select **Fax setup**, and then press **MENU/ENTER**.
3. Use the **<** or **>** button to select **All faxes**, and then press **MENU/ENTER**.
4. Use the **<** or **>** button to select **V.34**, and then press **MENU/ENTER**.



5. Use the < or > button to select **On** or **Off**, and then press **MENU/ENTER** to save the selection.

## Fax receive and fax send codes

The following tables list the fax receive and fax send codes that appear in the fax call report.

**Table 6-4. Fax receive codes**

Code	Description	Recommended action
<b>200</b>	The fax session has been completed without errors.	None required.
<b>221</b>	The user has pressed <b>CANCEL</b> , which caused the fax session to be prematurely halted.	Allow the product to receive the fax.
<b>222</b>	<p>The product has answered a call but has been unable to detect the presence of a fax machine. Typically, this is caused by the product answering a voice call.</p> <p>-Or-</p> <p>The remote user canceled the fax transmission by pressing <b>CANCEL</b> immediately before, or just as, the product answered the call.</p> <p>-Or-</p> <p>The remote machine automatically ended the call immediately before, or just as, the product answered the call.</p> <p>-Or-</p> <p>The remote (calling) fax machine identified a feature incompatibility between the two machines and disconnected immediately before transmitting any additional fax tones or T.30 frames. (This is a very rare and non-standard behavior.)</p>	<ol style="list-style-type: none"> <li>1. Confirm that the remote caller is a fax machine and not a voice call. (Typically the remote user must inform the caller that the fax session failed.)</li> <li>2. If the remote machine ends the call just as the product starts receiving, reduce the ring count after which the product answers. Or, suggest that the remote user manually dial to the product and then manually start the fax session by pressing <b>START</b> after fax tones have been heard from the product.</li> <li>3. Confirm that the remote user is not inadvertently attempting a poll transmission from the product instead of transmitting to the product.</li> <li>4. Reconfigure the local fax machine to use different configuration settings, change ECM to the opposite of the current setting, and/or select a slower reception speed.</li> </ol>
<b>223 (ECM error)</b>	The product has been unable to receive an entire page even after multiple attempts to receive the parts of the page that contain errors. This is usually caused by extremely poor line conditions.	<p>Attempt to receive the fax again after telephone-line conditions have improved.</p> <p>-Or-</p> <p>Set the ECM to <b>Off</b>. Errors might still occur, which might result in degraded image quality on the received page. However, the ability to receive the entire document will be improved.</p>

**Table 6-4. Fax receive codes (continued)**

Code	Description	Recommended action
224	The product has received one or more pages that contain excessive errors. This is usually caused by extremely poor line conditions. Because the ECM is not used during this session, errors are not corrected. Some non-HP machines might try to resend the failed pages, but it is impossible to determine from the resent pages if the problems with the previously received pages have been corrected.	Attempt to receive the fax again after telephone-line conditions have improved.
225	The remote machine has attempted to initiate a remote diagnostic session with this machine, even though remote diagnostic access is locally disabled.	Enable the remote diagnostics capability on the product.
226	The remote machine has attempted to initiate a remote diagnostic session with this machine, but the remote diagnostic versions that the two machines support are incompatible.	None. Remote diagnostics cannot occur between machines that have incompatible remote diagnostic versions.
227	The remote machine has attempted to initiate a fax session at a speed and modulation that the product does not support.	Reconfigure the product to receive at a slower speed.
228	The remote machine has attempted to initiate a poll transmission from the product even though the product is not configured for poll transmission.	<ol style="list-style-type: none"> <li>1. Confirm that the remote user intends to use polling. The remote user might have inadvertently attempted to poll. If this is the case, reattempt a normal transmission from the remote machine.</li> <li>2. If the remote user intended to use polling, confirm that the product was correctly configured for poll transmission.</li> </ol>
229	The remote machine has attempted to initiate a secure poll transmission from the product but has not provided a valid password.	Confirm that the remote user is the person for whom the polled document is intended. If so, make sure that the remote user has the correct password and that the product is configured with the same password.
230	The remote machine has attempted to initiate an operation that requires error correction but has not selected error correction for the session.	Enable the ECM on both the product and the remote machine.
231	The remote machine has attempted to initiate a transmission to the product even though the ability to receive is disabled at the product.	Ensure that the product is capable of receiving a document. Check that paper is correctly loaded, paper is not jammed within the machine, and any other system abnormalities have been cleared.

**Table 6-4. Fax receive codes (continued)**

Code	Description	Recommended action
<b>232 233 234 235 (ECM error) 236 (ECM error) 237</b>	<p>A communication failure has occurred between the two machines.</p> <p>-Or-</p> <p>The user at the remote machine might have pressed <b>CANCEL</b>.</p> <p>-Or-</p> <p>The power at the remote machine has been interrupted or deliberately turned off, causing the fax session to be interrupted.</p>	<ol style="list-style-type: none"> <li>1. Attempt to receive the fax again after telephone-line conditions have improved.</li> <li>2. If the error persists, and error correction is in use for the fax session, disable the ECM.</li> </ol>
<b>238 239 (ECM error) 240 (ECM error) 241 (ECM error)</b>	<p>The remote fax machine sent an unexpected communication.</p>	<p>None. This is a defect in the remote sending machine.</p>
<b>242</b>	<p>The remote fax machine is attempting to receive instead of send. Both machines have attempted to start receiving at the same time.</p> <p>It is possible to accidentally initiate a fax reception after dialing on many machines, if there is no paper in the machine, or if the paper is not correctly loaded and cannot be sensed by the appropriate document sensor.</p>	<p>Ensure that a document is ready and is correctly loaded in the transmitting fax machine and that the remote machine is attempting to transmit and not to receive.</p>
<b>243 244</b>	<p>The user of the remote machine has pressed the Stop button on that machine, which caused the session to be prematurely terminated.</p> <p>-Or-</p> <p>The remote fax machine identified a feature incompatibility between the two machines and has terminated the session. For example, the product tried to initiate polling, but the remote machine did not support this mode of operation.</p>	<ol style="list-style-type: none"> <li>1. Confirm that the remote user is not inadvertently attempting a poll transmission from the product, instead of transmitting to the product. This mode of operation must be specially configured on the product. If poll transmission from the product is the appropriate mode of operation, confirm that the product has been configured for this operation.</li> <li>2. Reconfigure the local fax machine to use different configuration settings, change the ECM setting to the opposite of the current setting, or select a slower reception speed.</li> </ol>

**Table 6-4. Fax receive codes (continued)**

Code	Description	Recommended action
<b>245 246 (ECM error)</b>	<p>The user of the remote machine has pressed the Stop button on that machine, which caused the session to be prematurely terminated.</p> <p>The product has been “holding off” the remote machine during reception of a large or complex document because the remote machine lacks available memory. This hold-off time has exceeded the timeout (typically 60 seconds) that the remote machine uses, and the remote machine has terminated the session.</p>	<ol style="list-style-type: none"> <li>1. If the document was large, ask the remote user to retransmit the document as two or more smaller documents.</li> <li>2. Disable ECM and attempt to receive the fax again.</li> </ol>
<b>247 - 251</b>	The remote machine is apparently stuck in the “on” mode.	None.
<b>252</b>	Telephone-line conditions were too poor to receive a fax.	<ol style="list-style-type: none"> <li>1. Attempt to receive the fax again after telephone-line conditions have improved.</li> <li>2. Configure the machine to start receiving at a lower speed.</li> <li>3. If the product successfully received several pages of a larger document, ask the remote user to transmit the document in several smaller parts.</li> </ol>
<b>253</b>	The remote machine has attempted to initiate a page transmission using a page width that is not supported by the product.	Ask the remote user to reconfigure the remote machine to transmit using a “normal” (letter/ A4) page width.
<b>281</b>	The product has not received any data at the start of a page during non-ECM reception although the modem has not detected a remote disconnect. The remote machine is probably transmitting fill bytes instead of data, and is either broken or jammed.	Ask the remote user to check his or her machine, and then ask the remote user to send the fax again.
<b>282</b>	The product has not received any data at the start of a page during ECM reception although the modem has not detected a remote disconnect. The remote machine is probably transmitting sync frames instead of data, and is either broken or jammed.	Ask the remote user to check his or her machine, and then ask the remote user to send the fax again.
<b>283</b>	The product has detected that the modem carrier has stopped. Either the line has been disconnected or the remote machine has aborted the transmission.	Ask the remote user to check his or her machine, and then ask the remote user to send the fax again.

**Table 6-4. Fax receive codes (continued)**

Code	Description	Recommended action
284	The product has not received any data during non-ECM page reception and a timeout failure has occurred. The remote machine is probably transmitting fill bytes instead of data, and is either broken or jammed.	Ask the remote user to check his or her machine, and then ask the remote user to send the fax again.
285	The product has stopped receiving any data during an ECM page reception although the modem has not detected a remote disconnect. The remote machine is probably transmitting sync frames instead of data, and is either broken or jammed.	Ask the remote user to check his or her machine, and then ask the remote user to send the fax again.
286	The remote machine has transmitted invalid data. The product has received frames with errors during an ECM reception and requested retransmission of the failed frames. The data that is resent does not correspond to the data that was requested. This is an implementation error from the remote machine.	Disable ECM, and ask the remote user to send the fax again.
290	Between pages, the remote machine has attempted to renegotiate the session mode from ECM to non-ECM. This operation is not supported, and the session has been abandoned.	Ask the remote user to send the fax again, and to split the document into two portions: the ECM and non-ECM portions. Some machines will attempt to use non-ECM for photo mode, so this might be associated with a between-page encoding change to support photo mode.
291	This is not a communication error, and it is not expected that this error will occur under non-development scenarios. Reception has failed because the local unit is unable to open to receive data. This error might be associated with low memory, although low memory should not produce the error unless other conditions are contributing to the problem.	If the error persists, turn the product off and then on again.
292	The remote machine has attempted to renegotiate the encoding mode from non-JPEG to JPEG. This operation is not supported, and the session has been abandoned.	Ask the remote user to send the fax again, and to split the document into two portions: the JPEG and non-JPEG portions. Some machines will attempt to use JPEG for photo mode, so this might be associated with a between-page encoding change to support photo mode.

**Table 6-5. Fax send codes**

<b>Code</b>	<b>Description</b>	<b>Recommended action</b>
<b>300</b>	The fax session has been completed without errors.	None required.
<b>311</b>	The user has pressed the <b>STOP</b> button, which caused the session to be prematurely halted before all pages have been transmitted.	None required.
<b>312</b>	A remote fax device has failed to answer the call. Specifically, fax tones or the fax handshake from a remote machine has not been detected. Typically this is caused by the user calling the wrong number, or when the correct number has been called but the machine has been configured not to answer, or when the remote machine has been temporarily disabled because of a condition such as a lack of paper or a jam.	Confirm that the remote fax machine is ready to receive a document, and attempt to send the fax again.
<b>313</b>	A busy signal has been detected each time that the product has attempted to call the remote machine.	Attempt to send the fax again when the line is no longer busy.
<b>314</b>	The product has attempted to initiate a remote diagnostic session but has detected that remote diagnostics are disabled at the remote machine.	Ask the remote user to enable remote diagnostics on the remote machine.
<b>315</b>	The product has attempted to initiate a remote diagnostic session but has detected that the remote diagnostic version supported by the remote machine is incompatible.	No solution. Remote diagnostics cannot occur between machines that have incompatible remote diagnostic versions.
<b>316</b>	The product is set up to initiate document transmission, but it has detected that the remote machine is not able to receive a document. This error should be rare because a remote machine normally will not answer if it cannot receive a document. An exception is if the remote machine is configured for poll transmission but is unable to receive.	Configure the remote machine for reception. Typically the remote user configures the remote machine, which can include loading paper, clearing jams, and clearing other system abnormalities.
<b>317</b>	The remote machine cannot support a fax reception at any speed or modulation that the product supports.	None.
<b>318</b>	The remote machine cannot support a fax reception at the page width that the product selected.	None.

**Table 6-5. Fax send codes (continued)**

Code	Description	Recommended action
319	The product has attempted to initiate a binary file transfer (BFT) but has detected that the remote machine does not support this mode of operation.	<ol style="list-style-type: none"> <li>1. Ask the remote user to enable the BFT capability on the remote machine if it is supported.</li> <li>2. Retransmit the document as a normal fax, rather than attempting a BFT transfer.</li> </ol>
320	The product is set up to initiate poll reception with a remote machine, but it has detected that the remote machine is not configured to do this. Poll transmission from a remote machine is typically configured on a session-by-session basis.	<p>Confirm that the local user wants to attempt a poll reception. If not, reconfigure the product for a normal fax transmission.</p> <p>-Or-</p> <p>Configure the remote machine for poll transmission. The remote user must first load a document to transmit and then configure the machine for polling.</p>
321	A communication error with the receiving fax machine was caused by poor telephone-line conditions.	Attempt to send the fax again when telephone-line conditions have improved.
322 - 324	Telephone-line conditions are too poor to send a fax.	<ol style="list-style-type: none"> <li>1. Attempt to send the fax again when telephone-line conditions have improved.</li> <li>2. If the session fails after transmitting several pages of a large document, retransmit the document as several smaller documents.</li> </ol>
325 - 328 (ECM error)	Telephone-line conditions are poor.	<p>Attempt to send the fax again when telephone-line conditions have improved.</p> <p>-Or-</p> <p>Disable ECM. Errors might still occur, and might result in a degraded image quality on the received page. However, the ability to transmit the entire document will be improved.</p>
329 - 331	The remote machine has reported that one or more pages have been received (while ECM was off) with excessive errors. This error does not result in the session being terminated immediately. Subsequent page transmission can still occur, and later pages might be received without error.	<p>Attempt to send the fax again when telephone-line conditions have improved.</p> <p>-Or-</p> <p>Select a lower speed for the initial transmission speed.</p>
332 - 343	A defect exists in the remote fax machine.	Send to or receive from another fax machine.

**Table 6-5. Fax send codes (continued)**

Code	Description	Recommended action
<b>344 - 348 349-353 (ECM error) 354-355</b>	<p>The remote machine has failed to respond to a fax command from the product because the connection is interrupted.</p> <p>-Or-</p> <p>The remote user has pressed the Stop button while the remote machine was receiving.</p> <p>-Or-</p> <p>Under rare conditions, incompatibility between the two machines can cause the remote machine to simply abandon the call.</p>	<ol style="list-style-type: none"> <li>1. Attempt to send the fax again when telephone-line conditions have improved.</li> <li>2. If the fax session was using error correction, disable ECM.</li> </ol>
<b>356 - 361 362-366 (ECM error)</b>	<p>The remote user has pressed the Stop button, which caused the session to be aborted.</p> <p>-Or-</p> <p>The remote machine has encountered a system problem (such as no paper or a jam), which has inhibited it from receiving any more pages, and which has caused it to terminate the session prematurely.</p> <p>-Or-</p> <p>The remote machine has encountered a feature incompatibility, which caused it to terminate the session.</p>	<ol style="list-style-type: none"> <li>1. Configure the remote machine for document reception by clearing any paper jams, loading sufficient paper, and clearing any other system errors.</li> <li>2. Configure the local fax machine to use different configurations, toggle the ECM state, or select a slower reception speed.</li> </ol>
<b>367 - 372 373-377 (ECM error) 378-379</b>	<p>The remote machine is apparently stuck in the "on" mode.</p>	<p>None.</p>
<b>380</b>	<p>The remote machine has failed to issue a valid response to a CTC frame. This occurs during ECM transmission after multiple retransmissions of erroneous data.</p>	<p>None; a defect exists in the remote machine.</p>
<b>381</b>	<p>The remote machine has failed to respond to a fax command from the product because the connection is interrupted.</p> <p>-Or-</p> <p>The remote user has pressed the Stop button while the remote machine was receiving.</p>	<ol style="list-style-type: none"> <li>1. Attempt to send the fax again when telephone-line conditions have improved.</li> <li>2. Disable ECM.</li> </ol>



**Table 6-5. Fax send codes (continued)**

Code	Description	Recommended action
382	The remote fax machine has been "holding off" the local fax machine from continuing the ongoing transmission because of a temporary low-memory condition at the remote machine. If this "hold-off" period exceeds a machine's specific timeout value, the session is terminated.	Resend the document as two or more separate fax transmissions. Wait several minutes between the end of one transmission and the start of the next transmission.  -Or- Disable ECM.
383	The remote machine has failed to respond to a fax command from the product because the connection was interrupted.  -Or- The remote user has pressed the Stop button while the remote machine was receiving.	Attempt to send the fax again when telephone-line conditions have improved  -Or- Disable ECM.
384	The product has attempted a black JPEG transmission to a machine that does not support this mode.	Use a different mode, and attempt to send the fax again.
386	The product has failed to complete phase 3 of the initial V.34 handshake after originating a fax session. This is usually caused by poor line conditions, although it might be a compatibility issue with certain machines or line conditions.	<ol style="list-style-type: none"> <li>1. Attempt to send the fax again when telephone-line conditions have improved.</li> <li>2. Disable V.34 on the product and attempt the transmission with the V.17 mode.</li> </ol>
387	The product has failed to successfully negotiate the initial V.8 handshake with the remote machine after originating a fax session. Typically, this occurs when the remote machine is not fax-capable or has disabled reception. It might also be a compatibility issue with certain machines or line conditions.	<ol style="list-style-type: none"> <li>1. Attempt to send the fax again when telephone-line conditions have improved.</li> <li>2. Disable V.34 on the product and attempt the transmission using the V.17 mode.</li> </ol>
388	The product has originated a fax session and detected a remote fax machine but has been unable to detect any T30 frames. If the machine is in V.17 mode, the connection probably has been interrupted. In V.34 mode, this error might also occur because of compatibility problems with certain machines or line conditions.	<ol style="list-style-type: none"> <li>1. Attempt to send the fax again when telephone-line conditions have improved.</li> <li>2. Disable V.34 on the product and attempt the transmission with the V.17 mode.</li> </ol>
389	The product has originated a fax session and has reattempted V.8 negotiations multiple times without success.	<ol style="list-style-type: none"> <li>1. Attempt to send the fax again when telephone-line conditions have improved.</li> <li>2. Disable V.34 on the product and attempt the transmission with the V.17 mode.</li> </ol>

**Table 6-5. Fax send codes (continued)**

Code	Description	Recommended action
390	The product has originated a fax session while using error correction (either V.34 or V.17). Transmission of an image has been abandoned after a timeout when no data has become ready for transmission. This is most likely caused by a low-memory condition, although it could be caused by other internal problems that cause data generation for transmission to stall.	Attempt to send the fax again after making sure that documents stored in memory are printed, and that the unit has paper ready for printing. If the problem persists, reinitialize permanent storage.
391	The product has originated a fax session without error correction (not V.34). Transmission of an image has been abandoned after a timeout when no data has become ready for transmission. This is most likely caused by a low-memory condition, although it could be caused by other internal problems that stall the data generation for transmission.	Attempt to send the fax again after making sure that documents that are stored in memory are printed, and that the unit has paper ready for printing. If the problem persists, reinitialize permanent storage.
392	The product has answered a fax session and completed the initial V.34 handshake but has been unable to detect any T.30 frames. This failure is caused by either compatibility problems with certain machines or line conditions.	<ol style="list-style-type: none"> <li>1. Ask the remote user to send the fax again when telephone-line conditions have improved.</li> <li>2. Disable V.34 on the product and attempt the transmission with the V.17 mode.</li> </ol>
393	The product has failed to complete phase 3 of the initial V.34 handshake after answering a fax session. This is usually caused by poor line conditions, although it might be a compatibility issue with certain machines or line conditions.	<ol style="list-style-type: none"> <li>1. Ask the remote user to send the fax again when telephone-line conditions have improved.</li> <li>2. Disable V.34 on the product and attempt the transmission with the V.17 mode.</li> </ol>
394	The product has failed to successfully negotiate the initial V.8 handshake with the remote machine after answering a fax session. Typically, this occurs when the calling machine is not fax-capable. It might also be a compatibility issue with certain machines or line conditions.	<ol style="list-style-type: none"> <li>1. Ask the remote user to send the fax again when telephone-line conditions have improved.</li> <li>2. Disable V.34 on the product and attempt the transmission with the V.17 mode.</li> </ol>
395	An unexpected T.30 frame has been received between pages during a multipage V.34 reception. This is almost certainly a compatibility problem with the remote machine, and might be caused by an error with the implementation of the remote machine.	<ol style="list-style-type: none"> <li>1. Ask the remote user to send the fax again when telephone-line conditions have improved.</li> <li>2. Disable V.34 on the product and attempt the transmission with the V.17 mode.</li> </ol>

**Table 6-5. Fax send codes (continued)**

Code	Description	Recommended action
<b>396-409</b>	An error occurred during a V.34 transmission when the product was unable to correctly complete the handshake with the remote machine and was consequently unable to transmit a T.30 frame. This occurs when the line was disconnected or if line conditions degrade during the session.	Attempt to receive the fax again when telephone-line conditions have improved.
<b>410-419</b>	An error occurred during a V.34 reception when the product was unable to correctly complete the handshake with the remote machine and was consequently unable to transmit a T.30 frame. This occurs when the line is disconnected or if line conditions degrade during the session.	Attempt to receive the fax again when telephone-line conditions have improved.
<b>420</b>	V.34 negotiations have failed from the originating machine during phase 4. Phase 4 occurs after V.8 and before the first T.30 frames are exchanged. These compatibility problems have been observed when sending to non-HP units.	Attempt to receive the fax again when telephone-line conditions have improved.
<b>421</b>	V.34 negotiations have failed from the originating machine during phase 3. Phase 3 occurs after V.8, before phase 4, and before the first T.30 frames are exchanged. These compatibility problems have been observed when sending to non-HP units.	Attempt to receive the fax again when telephone-line conditions have improved.
<b>422</b>	V.34 negotiations have failed from the answering machine during phase 4. Phase 4 occurs after V.8 and before the first T.30 frames are exchanged.	Ask the remote user to send the fax again when telephone-line conditions have improved.
<b>423</b>	V.34 negotiations have failed from the answering machine during phase 3. Phase 3 occurs after V.8, before phase 4, and before the first T.30 frames are exchanged.	Ask the remote user to send the fax again when telephone-line conditions have improved.
<b>430</b>	The transmitting machine is unable to send continuous "ones" at the end of the control channel before starting the primary channel. This is a V.34 error. This error might be associated with line conditions, although it is more likely to be caused by internal modem problems.	Ask the remote user to send the fax again when telephone-line conditions have improved.

**Table 6-5. Fax send codes (continued)**

Code	Description	Recommended action
431	The transmitting machine has not received a response after aborting a transmission. Depending upon when the session is aborted, some remote machines might not respond. The product always attempts to abort the session in such a way that the remote machine can respond to the final PPS_EOP.	No action required. The session was aborted.
440-444	An error occurred during a V.34 transmission after one or more partial pages (image data) were transmitted through the primary channel. The transmitting machine was unable to restart the control channel in order to resume the T.30 handshake. This typically occurs when the receiving machine prematurely disconnects while receiving a partial page, although the problem can be caused by compatibility issues.	Attempt to receive the fax again when telephone-line conditions have improved.

**Translating the fax trace report (HP LaserJet 3015 and 3030 only)**

Print a fax log report. The fax log report contains information about the product's interpretation of the problem.

Read the time sequences, looking for abnormal activity on the fax trace report. See [Table 6-6. Fax phase sequence \(HP LaserJet 3015 and 3030 only\)](#), and [Table 6-7. Appropriate responses \(HP LaserJet 3015 and 3030 only\)](#), to separate normal from abnormal activity. Fax abbreviations appear in [Table 6-8. Fax abbreviations \(HP LaserJet 3015 and 3030 only\)](#).

Identify the phase in which the error occurred.

**Note**

??? represents an unidentified command.

Examples of a successfully sent fax and a successfully received fax appear after the tables.

**Table 6-6. Fax phase sequence (HP LaserJet 3015 and 3030 only)**

Sequence	Calling station	Called station
<b>Phase A—Call setup sequence</b>		
1	Ring signal	
2	CNG tone beep, 500 Hz for 1 second	
3		Transmit CED, 2100 Hz for 3 seconds
4		Transmit NSF
5		Transmit CSI
6		Transmit DIS

**Table 6-6. Fax phase sequence (HP LaserJet 3015 and 3030 only) (continued)**

Sequence	Calling station	Called station
7	DIS detected	
<b>Phase B—Pre-message procedure (negotiate compatible format/protocol) (HP LaserJet 3015 and 3030 only)</b>		
8	Transmit TSI	
9	Transmit DCS, select mode	
10		DCS detected
11	Transmit TCF/training	
12	Transmit FSK	
13		Training (synchronize signals), check for errors
14		Transmit CFR
15	Detect CFR	
<b>Phase C—Message transmission (page/scan transmission) (HP LaserJet 3015 and 3030 only)</b>		
16	Transmit message (FSK, followed by date)	
17		Receive message (SCAN), check for errors
18	Transmit FSK	
19	At end of message, send one of the following: <ul style="list-style-type: none"> <li>• EOM</li> <li>• EOP</li> <li>• MPS</li> <li>• PRI-Q</li> <li>• PPS-NULL</li> <li>• PPS-MPS</li> <li>• PPS-EOM</li> <li>• PPS-EOP</li> <li>• PPS-PRI-Q</li> </ul>	
<b>Phase D—Post-message transmission (next page/end of transmission) (HP LaserJet 3015 and 3030 only)</b>		
20		Detect EOM, EOP, MPS, PRI-Q, PPS-NULL, PPS-MPS, PPS-EOM, PPS-EOP, or PPS-PRI-Q
21		Transmit MCF response to confirmation signals of post-message responses
<b>Phase E—Call release (hang up sequence) (HP LaserJet 3015 and 3030 only)</b>		

**Table 6-6. Fax phase sequence (HP LaserJet 3015 and 3030 only) (continued)**

Sequence	Calling station	Called station
21	Transmit DCN	
22		Station hangs up

**Table 6-7. Appropriate responses (HP LaserJet 3015 and 3030 only)**

Commands	Comments	Appropriate responses
(NSF) (CSI) DIS	Identifying capabilities: from a manual receiver or an auto-answer unit	(NSC) (CIG) DTC (TSI) DCS (NSF) (CSI) DIS (CRP) (TSI) (NSS) (PWD) (SEP) (CIG) DTC (PWD) (SUB) (TSI) DCS
(NSC) (CIG) DTC	Mode-setting command: from calling unit	(TSI) DCS (NSF) (CSI) DIS
(PWD) (SEP) (CIG) DTC	Poll operation	(CRP) (TSI) (NSS)
(TSI) DCS (TSI) (NSS)	Mode-setting command: from manual transmitter or automatic receiver	CFR FTT (NSC) (CIG) DTC
(PWD) (SUB) (TSI) DCS	Command is always followed by phasing/training	(NSC) (CIG) DTC
CTC	Mode-setting command: from the transmitter to the receiver	(CTR) (CRP)
(EOR-NULL)	Indicates the next block transmission from the transmitter to the receiver	(ERR) (RNR) (CRP)
Any one of the following: <ul style="list-style-type: none"> <li>• (EOR-EOP)</li> <li>• (EOR-EOM)</li> <li>• (EOR-PRI-MPS)</li> <li>• (EOR-PRI-EOP)</li> <li>• (EOR-PRI-EOM)</li> </ul>	The receiver <ul style="list-style-type: none"> <li>(ERR)</li> <li>(RNR)</li> <li>PIN</li> <li>(CRP)</li> </ul>	
Any one of the following: <ul style="list-style-type: none"> <li>• MPS</li> <li>• EOP</li> <li>• EOM</li> <li>• (PRI-MPS)</li> <li>• (PRI-EOP)</li> <li>• (PRI-EOM)</li> </ul>	Post-message commands	MCF RTP RTN PIP PIN (CRP)
(PPS-NULL)	Post-message command for a partial page from the transmitter to the receiver	(PPR) MCF (RNR) (CRP)

**Table 6-7. Appropriate responses (HP LaserJet 3015 and 3030 only) (continued)**

Commands	Comments	Appropriate responses
Any one of the following: <ul style="list-style-type: none"> <li>• (PPS-MPS)</li> <li>• (PPS-EOP)</li> <li>• (PPS-EOM)</li> <li>• (PPS-PRI-MPS)</li> <li>• (PPS-PRI-EOP)</li> <li>• (PPS-PRI-EOM)</li> </ul>	Post-message commands for a complete page from the transmitter to the receiver	(PPR) MCF (RNR) PIP PIN (CRP)
(RR)	Ask for the status of the receiver: from the transmitter to the receiver	(RNR) (ERR) MCF PIP PIN (CRP)
DCN	Phase E command	None

**Table 6-8. Fax abbreviations (HP LaserJet 3015 and 3030 only)**

Abbreviation	Function	Signal format ("X"= any #)
CED	Called station identification	2100 Hz
CFR	Confirmation to receive	X010 0001 1850 or 1650 Hz for 3 seconds
CIG	Calling subscriber identification	1000 0010
CNG	Calling tone	1100 Hz for 500 ms
CRP	Command repeat	X101 1000
CSI	Called subscriber identification	0000 0010
CTC	Continue to correct	X100 1000
CTR	Response to continue to correct	X010 0011
DBM	-dBm signal strength detected from sending station (number is deviation from average value)	Range in -7.5 to -43 (-43 is a weak signal; see the explanation that follows <a href="#">Figure 6-18. Example of a T.30 trace of a successfully received fax</a> )
DCN	Disconnect	X101 1111
DCS	Digital command signal	X100 0001
DIS	Digital identification signal	0000 0001
DTC	Digital transmit command	1000 0001
EOM	End of message	X111 0001 1100 Hz

**Table 6-8. Fax abbreviations (HP LaserJet 3015 and 3030 only) (continued)**

Abbreviation	Function	Signal format ("X"= any #)
EOP	End of procedure	X111 0100
EOR	End of retransmission	X111 0011
EQM	Eye quality monitor—a measure of the modem signal quality, lower numbers indicate better signals	0-99
ERR	Response for end of retransmission	X011 1000
ECD	Facsimile coded date	0110 0000
FCF	Facsimile	
FCS	Frame check sequence	
FDM	File diagnostics message	X011 1111
FIF	Facsimile information field	
FSK	Frequency shift key: Low-speed command identifier separating commands/scans; precedes command mode	
FTT	Failure to train: The 1.5 seconds of the Training Check Frame (TCF) indicates line conditions are not good enough for this modulation	X010 0010
GC	Group command	2100 Hz for 1.5 to 100 seconds
GI	Group identification	1850 Hz
HDLC	High-level data link control	
LCS	Line conditioning signals	1100 Hz
MCF	Message confirmation	X011 0001 1850 Hz
MSG	Message received high speed data	
MPS	Multipage signal	X111 0010
NSF	Nonstandard facilities command	1000 0100
NSF	Nonstandard facilities	0000 0100
NSS	Nonstandard setup	X100 0100
PID	Procedure interrupt disconnect	X011 0110
PIN	Procedural interrupt negative	X011 0100
PIP	Procedural interrupt positive	X011 0101
PIS	Procedural interrupt signal	462 Hz for 3 seconds



**Table 6-8. Fax abbreviations (HP LaserJet 3015 and 3030 only) (continued)**

Abbreviation	Function	Signal format ("X"= any #)
PPS	Partial-page signal	X111 1101
PPS-EOM	Partial-page signal—end of message	X111 1101
PPS-EOP	Partial-page signal—end of procedure	X111 1101
PPS-MPS	Partial-page signal—multipage signal	X111 1101
PPS-NULL	Partial-page signal—null	X111 1101
PPR	Partial-page request	X011 1101
PRI-EOM	Procedure interrupt—end of message	X111 1001
PRI-EOP	Procedure interrupt—end of procedure	X111 1100
PRI-MPS	Procedure interrupt—multipage signal	X111 1010
RCP	Return to control for partial page	0110 0001
RNR	Receive not ready	X011 0111
RR	Receive ready	X111 0110
RTC	Return to control mode	Six EOLs
RTN	Retrain negative	X011 0010
RTP	Retrain positive	X011 0011
TCF	Training check field	Zeroes for 1 5 5
TSI	Transmitting subscriber identification	X100 0010
PWD	Password (for polling)	1000 0011
PWD	Password (for transmission)	X100 0101
SCAN	Data-packets or scan-line count	
SEP	Selective polling	1000 0101
SUB	Sub-address	X100 0011
V.xx	Protocol version used (Group 3 only)	V.27 = 4800/2400 V.29 = 9600/7200 V.33 = 14400/12000 V.17 = 14400/12000/9600/7200
XID	Exchange identification procedure	
???	Unidentified command sequence	

# hp LaserJet 3015

HP LASERJET FAX  
222 555 1111  
Dec-1-2003 8:33PM



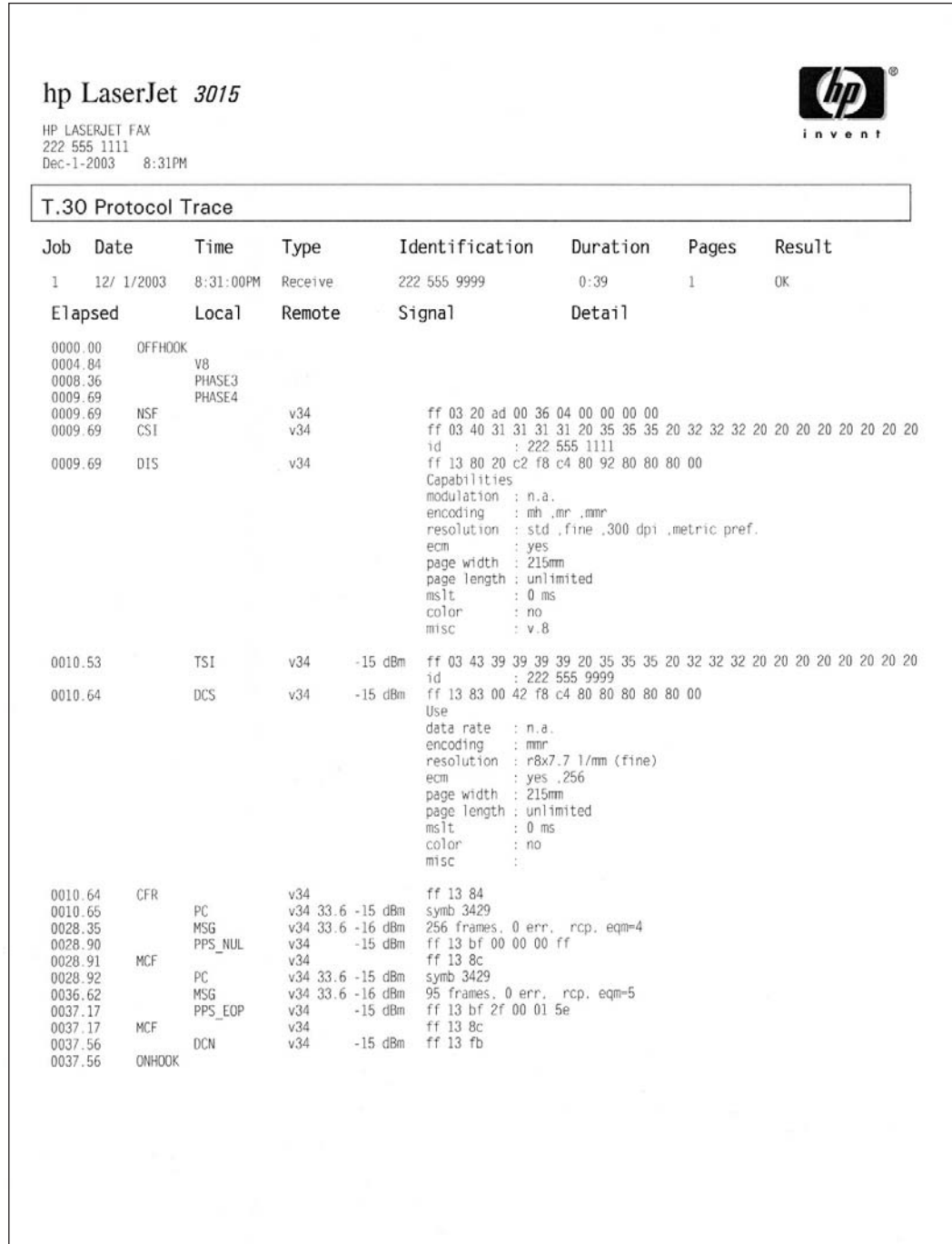
## T.30 Protocol Trace

Job	Date	Time	Type	Identification	Duration	Pages	Result
2	12/ 1/2003	8:32:28PM	Send	5559999	0:46	1	OK
Elapsed	Local	Remote	Signal	Detail			
0000.00	OFFHOOK						
0004.45	CNG						
0009.97	VB						
0013.50	PHASE3						
0014.86	PHASE4						
0015.07	NSF	v34	-16 dBm	ff 03 20 ad 00 36 04 00 00 00 00			
0015.25	CSI	v34	-16 dBm	ff 03 40 39 39 39 39 20 35 35 35 20 32 32 32 20 20 20 20 20 20			
				id : 222 555 9999			
0015.35	DIS	v34	-16 dBm	ff 13 80 20 c2 f8 c4 80 92 80 80 80 00			
				Capabilities modulation : n.a. encoding : mh ,mr ,mmr resolution : std ,fine ,300 dpi ,metric pref. ecm : yes page width : 215mm page length : unlimited mslt : 0 ms color : no misc : v.8			
0015.35	TSI	v34		ff 03 43 31 31 31 20 35 35 35 20 32 32 32 20 20 20 20 20 20 20			
				id : 222 555 1111			
0015.35	DCS	v34		ff 13 83 00 42 f8 c4 80 80 80 80 80 00			
				Use data rate : n.a. encoding : mmr resolution : r8x7.7 l/mm (fine) ecm : yes .256 page width : 215mm page length : unlimited mslt : 0 ms color : no misc :			
0015.98	CFR	v34	-16 dBm	ff 13 84			
0015.98	PC	v34	33.6	symb 3429			
0033.49	MSG	v34	33.6				
0033.90	PPS_NUL	v34		ff 13 bf 00 00 00 ff			
0034.23	MCF	v34	-16 dBm	ff 13 8c			
0034.24	PC	v34	33.6	symb 3429			
0042.63	MSG	v34	33.6				
0043.04	PPS_EOP	v34		ff 13 bf 2f 00 01 6c			
0043.38	MCF	v34	-16 dBm	ff 13 8c			
0043.38	DCN	v34		ff 13 fb			
0044.82	ONHOOK						

**Figure 6-17.** Example of a T.30 trace of a successfully sent fax

**Note**

Phase A, call establishment, does not show up on a trace report. Phase C is the phase in which faxed pages are transferred.



**Figure 6-18.** Example of a T.30 trace of a successfully received fax

## Service-mode functions

Use the following information to perform system-wide reset procedures and to adjust certain global settings such as the country/region. Users do not have access to this information.

### Secondary service menu

Use the secondary service menu to perform various tests and print service reports. The following is a hierarchical diagram of the secondary service menu.

Main menu	Submenu	Submenu
2ndary Service	Service Reports	Continuous Self-Test DS Fax DS No Fax Extended Keymap Translations Location codes Data Store Error Report
	Scan Calibration	
	Scanline data	Red-corrected Blue-corrected Green-corrected Red-uncorrected Blue-uncorrected Green-uncorrected
	Location	USA 1=Yes 2=No
	Clock Dithering	On Off
	Park Scanner	

#### To gain access to the secondary service menu

1. Make sure that the control-panel display reads **Ready**.
2. Press **MENU/ENTER**.
3. Press **2** on the keypad.

---

**Note**

You can gain access to the secondary service menu from any other menu by pressing **2**.

4. Use the **<** or **>** button to navigate the secondary service menu.

- To exit the secondary service menu and remove it from the menu tree, press **CANCEL** to return to the **Ready** display, and then press **CANCEL** again.

### To print a list of all the Fax data-store parameters

- From the secondary service menu, use the **<** or **>** button to select **Service reports**, and press **MENU/ENTER**.
- Use the **<** or **>** button to select **DS-Fax**, and press **MENU/ENTER**.

## Developer's menu

Use the developer's menu to adjust fax data-store parameters and to run various tests. The following is a hierarchical diagram of the developer's menu.

Main menu	Submenu	Submenu
Developer's menu	Display test	
	Read Register	
	Write Register	
	R/W parameter	
	Monitor test	Onhook monitor Offhook monitor Eavesdrop Test Signal Pwr Mon.
	LIU test	LIU inputs LIU ID
	Loopback test	
	Data Store	
	Transmit test	OFFHOOK ONHOOK DIAL NUMBER <hr/> <b>Note</b> Several other options are available under this menu. <hr/>

### To gain access to the developer's menu:

- Make sure that the control-panel display reads **Ready**.
- Press **MENU/ENTER**.
- Press the **\*** and **#** buttons simultaneously.

---

#### Note

You can gain access to the developer's menu from any other menu by pressing the **\*** and **#** buttons simultaneously.

4. Use the < or > button to navigate the developer's menu.
5. To exit the developer's menu and remove it from the menu tree, press CANCEL to return to the Ready display, and then press CANCEL again.

### To adjust fax data-store parameters

When you adjust fax data-store parameters, the product does not alert you to incorrect input values. Changing fax data-store parameters can render the product illegal or inoperable.

---

**Note**

---

Before adjusting the fax data-store parameters, you can print a list of all the parameters from the secondary service menu. See [To print a list of all the Fax data-store parameters](#).

1. On the developer's menu, use the < or > button to navigate to **R/W PARAMETER**, and then press MENU/ENTER.
2. Use the < or > button to locate the parameter that you want to change. The current setting appears on the control-panel display.
3. Type the new value for the fax data-store parameter, and then press MENU/ENTER.

### To scroll quickly to a particular data-store parameter

When **R/W PARAMETER** appears on the control-panel display, jump directly to any parameter ID that does not contain a 2 by typing the ID on the keypad. (Pressing 2 brings up the secondary service menu.) To change a parameter that has a 2 in its ID, type the ID of the closest parameter that does not have a 2 and then use the < or > button to locate the parameter that you want to change. For example, to move quickly to parameter 152, enter 151 >.

## Adjusting the country/region code parameters

Three situations can occur that necessitate changing the country/region or language settings for the product:

1. The customer has moved to a different country/region from where the product was purchased.
2. The information has been erased because of an NVRAM initialization, or the parameters are set to "undefined."
3. The formatter was replaced.

Use the information in the following sections to adjust the country/region and language settings.

### To change the country/region from one location to another

1. Press MENU/ENTER, and then press 2 to gain access to the **Secondary Service** menu.
2. Press < or > to select **Location**, and then press MENU/ENTER.
3. Press < or > until the correct location appears.
4. When the correct location appears, press MENU/ENTER. Press 1 to confirm the new location. The product automatically turns itself off and then on after the setting is confirmed.

## To set the language and location if none is set

If the language and location have been erased because NVRAM has been initialized or the formatter is replaced, the product automatically prompts for the language and the location when it is turned on.

---

### Note

---

**HP LaserJet 3015 and 3030 only:** The customer cannot send or receive faxes until these settings have been established.

1. Press < or > until the correct language appears.
2. When the correct language appears, press **MENU/ENTER**, and then press **1** to confirm the selection. If the location also needs to be set, the product automatically prompts for the location.
3. Press < or > until the correct country/region appears.

---

### Note

---

**HP LaserJet 3015 and 3030:** The list of countries/regions that appears on the control-panel display depends on the LIU that is installed in the product.

**HP LaserJet 3020:** This product does not have fax capabilities and so it does not have a LIU installed. The list of supported countries/regions that appears on the control-panel display are in a localized format.

4. When the correct country/region appears, press **MENU/ENTER**, and then press **1** to confirm the selection.
5. After both the language and the location settings are established, the product automatically turns itself off and then on.

## Soft reset

Before performing an NVRAM init, attempt a soft reset, which does not reset configuration settings or cause loss of data.

### To perform a soft reset

1. Press **MENU/ENTER**.
2. Simultaneously press then release the **\*** button and the **#** button to enter the Developer's menu.
3. Press the < or > button until the message **REINIT FFS** appears on the second line of the control-panel display.
4. Press **MENU/ENTER**.
5. The process takes approximately 2.5 minutes. During that time, the control-panel display will change several times before returning to **Ready**.
6. When the **Ready** message appears on the control-panel display, press **CANCEL** to exit the Developer's menu.

## NVRAM init

NVRAM init returns all stored parameters in NVRAM to factory default values or to a default ROM value, depending on the variable, and performs a system reset.

Performing NVRAM init can cause the product to violate local telephone regulations. Reset the language and country/region after performing NVRAM init.

NVRAM init resets the following settings and information:

- All menu settings are reset to factory default values, including fax header and company name.
- Factory settings such as formatter number, page counts, and factory paper settings are reset.
- All faxes in memory are erased.
- All speed-dials, group-dials, and phone book entries are erased.
- All localization settings, including language and country/region, are reset.

### To perform NVRAM init

1. Turn off the product.
2. Press and hold down the \* and MENU/ENTER buttons.
3. Continue to hold down the buttons while you turn on the product. Hold the buttons through the entire power-on sequence.
4. When **Permanent Storage Init.** appears on the control-panel display, release the buttons.
5. When the message **Language** appears on the control-panel display, set the correct language and country/region.
6. Allow the product to return to **Ready** before using the product.

## System settings for localized products

### Note

The HP LaserJet 3020 does not have a LIU because it does not have fax capabilities. The list of available country/regions includes all of the country/regions listed in [Table 6-9. System settings](#) and Chile (default media size letter, default date format ddmmyy, and default time format am/pm), North Africa (default media size A4, default date format ddmmyy, and default time format 24 hour), Jordan (default media size A4, default date format ddmmyy, and default time format am/pm), and Lebanon (default media size A4, default date format ddmmyy, and default time format am/pm).

Two LIUs are available for the product. The list of available countries/regions that appears in the **Secondary service** menu (in the **Location** submenu) varies according to the LIU that is installed in the product. The default system settings vary for each country/region. The following table lists the default system settings for each country/region. Be sure to reset any user-defined settings that differ from these settings.

**Table 6-9. System settings**

Country/region	LIU installed	Default media size <sup>1</sup>	Date format	Time format
Argentina	USA	Letter	ddmmyy	am/pm
Australia	USA	A4	ddmmyy	am/pm
Austria	Europe	A4	ddmmyy	24 hour
Belgium	Europe	A4	ddmmyy	24 hour
Brazil	USA	A4	ddmmyy	24 hour



**Table 6-9. System settings (continued)**

Country/region	LIU installed	Default media size <sup>1</sup>	Date format	Time format
Bulgaria	Europe	A4	ddmmyy	24 hour
Canada	USA	Letter	ddmmyy	am/pm
China	USA	A4	yymmdd	24 hour
Croatia	Europe	A4	ddmmyy	24 hour
Czech Republic	Europe	A4	ddmmyy	24 hour
Denmark	Europe	A4	ddmmyy	24 hour
Finland	Europe	A4	ddmmyy	24 hour
France	Europe	A4	ddmmyy	24 hour
Germany	Europe	A4	ddmmyy	24 hour
Greece	Europe	A4	ddmmyy	am/pm
Hong Kong SAR	USA	A4	yymmdd	am/pm
Hungary	Europe	A4	yymmdd	24 hour
India	USA	A4	ddmmyy	24 hour
Indonesia	USA	A4	ddmmyy	24 hour
Ireland	Europe	A4	ddmmyy	24 hour
Israel	Europe	A4	ddmmyy	24 hour
Italy	Europe	A4	ddmmyy	24 hour
Korea	USA	A4	yymmdd	am/pm
Luxemburg	Europe	A4	ddmmyy	24 hour
Malaysia	USA	A4	ddmmyy	24 hour
Mexico	USA	Letter	ddmmyy	am/pm
Netherlands	Europe	A4	ddmmyy	24 hour
New Zealand	USA	A4	ddmmyy	am/pm
Norway	Europe	A4	ddmmyy	24 hour
Pakistan	USA	A4	ddmmyy	am/pm
Peru	USA	Letter	ddmmyy	am/pm
Philippines	USA	Letter	mmddy	am/pm
Poland	Europe	A4	yymmdd	24 hour
Portugal	Europe	A4	ddmmyy	24 hour
Romania	Europe	A4	ddmmyy	24 hour
Russia	Europe	A4	ddmmyy	24 hour
Singapore	USA	A4	ddmmyy	am/pm

**Table 6-9. System settings (continued)**

Country/region	LIU installed	Default media size <sup>1</sup>	Date format	Time format
Slovak Republic	Europe	A4	ddmmyy	24 hour
South Africa	Europe	A4	yymmdd	am/pm
Spain	Europe	A4	ddmmyy	24 hour
Sri Lanka	USA	A4	ddmmyy	24 hour
Sweden	Europe	A4	yymmdd	24 hour
Switzerland	Europe	A4	ddmmyy	24 hour
Taiwan	USA	A4	yymmdd	am/pm
Thailand	USA	A4	ddmmyy	24 hour
Turkey	Europe	A4	ddmmyy	24 hour
United Kingdom	Europe	A4	ddmmyy	24 hour
United States	USA	Letter	mmddy	am/pm
Vietnam	USA	A4	ddmmyy	am/pm

<sup>1</sup>The default media-size setting that is listed is the same for the printer input trays and the fax glass-size setting.

## Printer job language (PJM) software commands

Many PJM scripts are available for restoring parameters such as paper size and page counts after the formatter has been replaced. For comprehensive instructions, see the *Printer Job Language Technical Manual* and the *Printer Job Language Technical Manual Addendum*.

# Main wiring

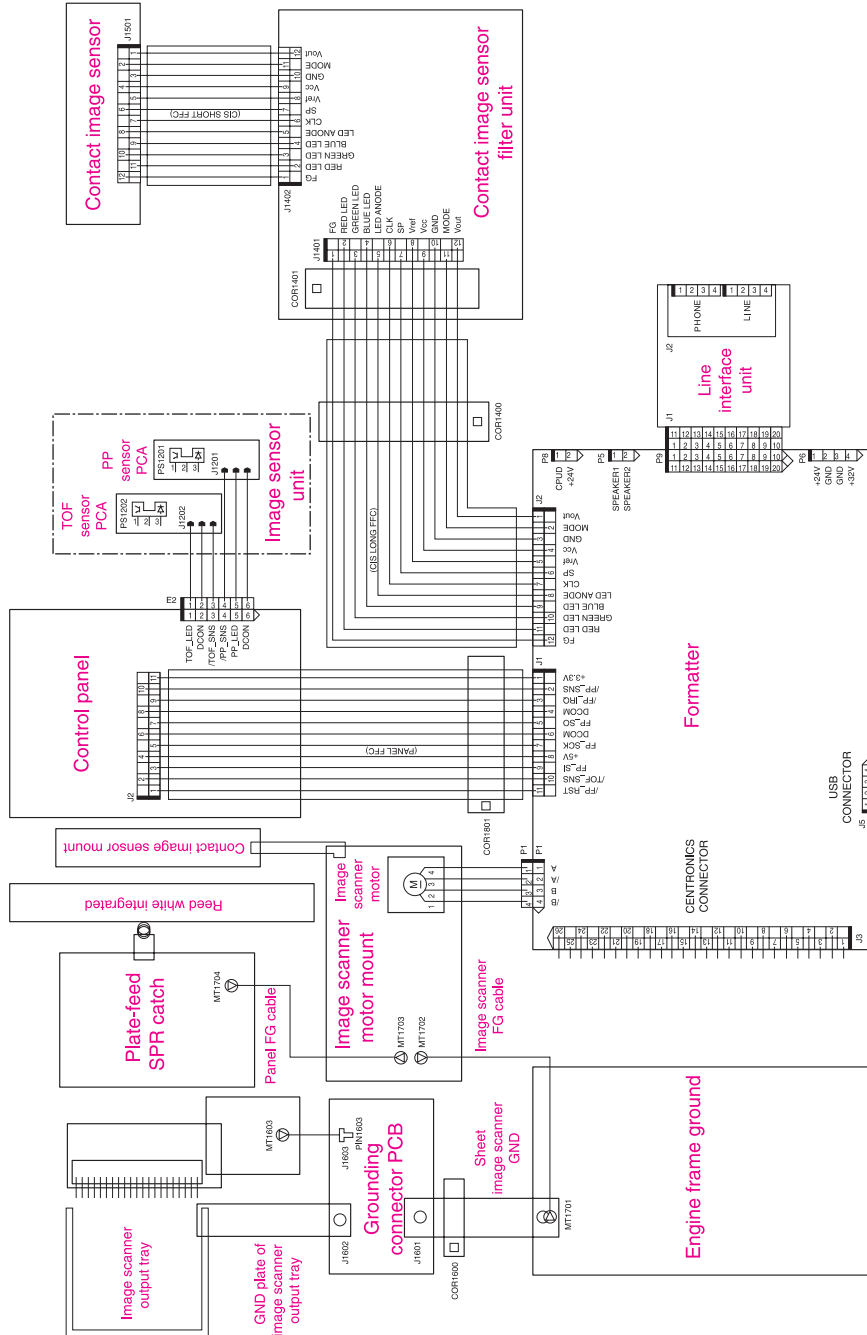


Figure 6-19. Main wiring, HP LaserJet 3015 scanner assembly

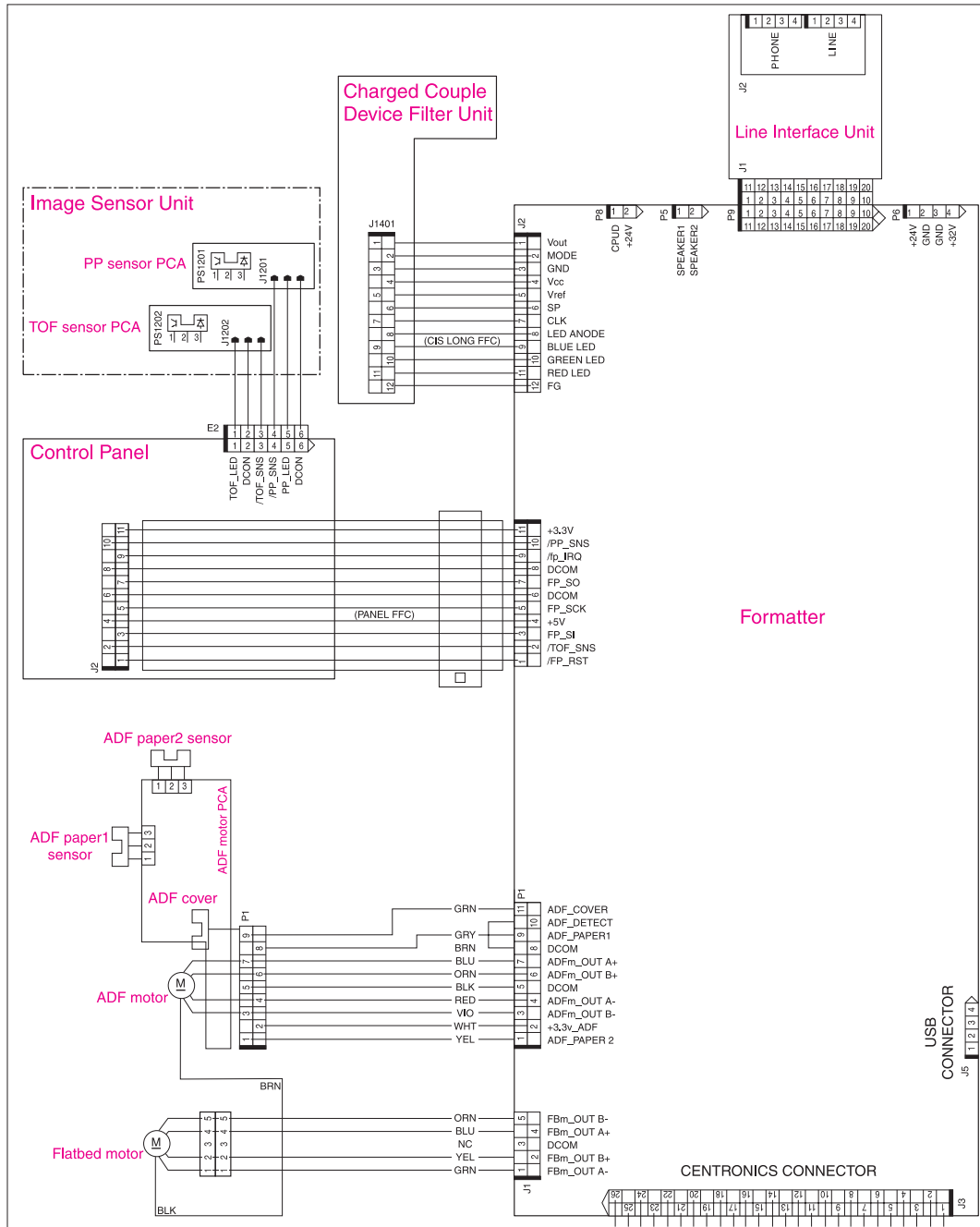


Figure 20. Main wiring, HP LaserJet 3020 and 3030 scanner assembly

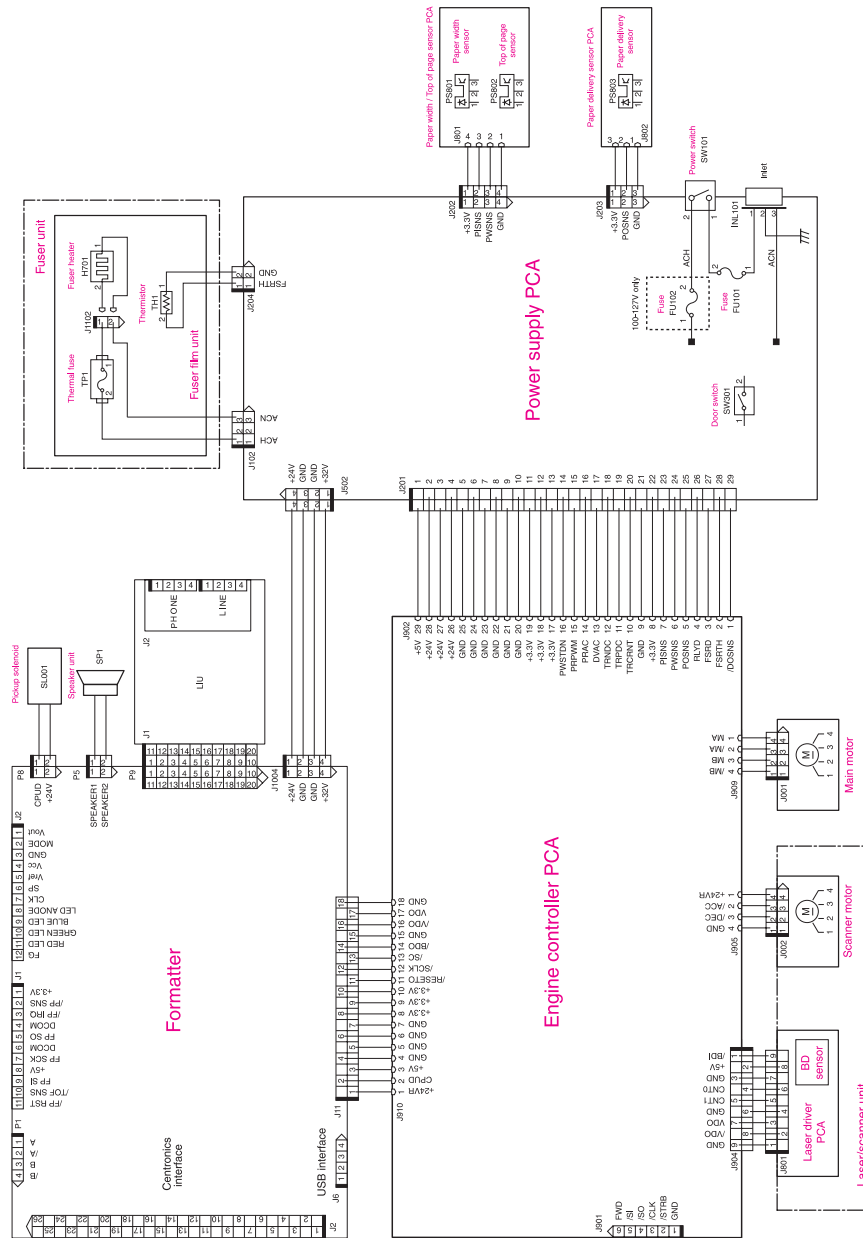
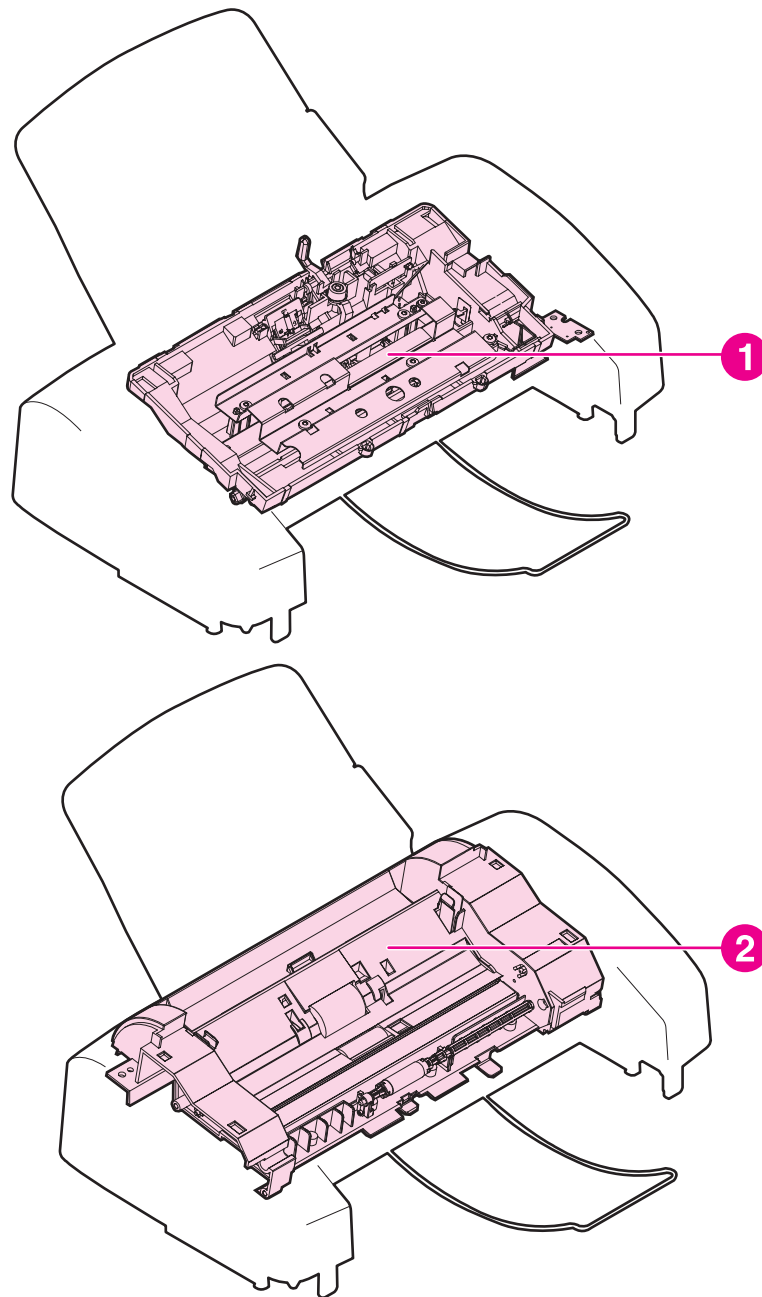


Figure 6-21. Main wiring, HP LaserJet 3015, 3020, and 3030 product base

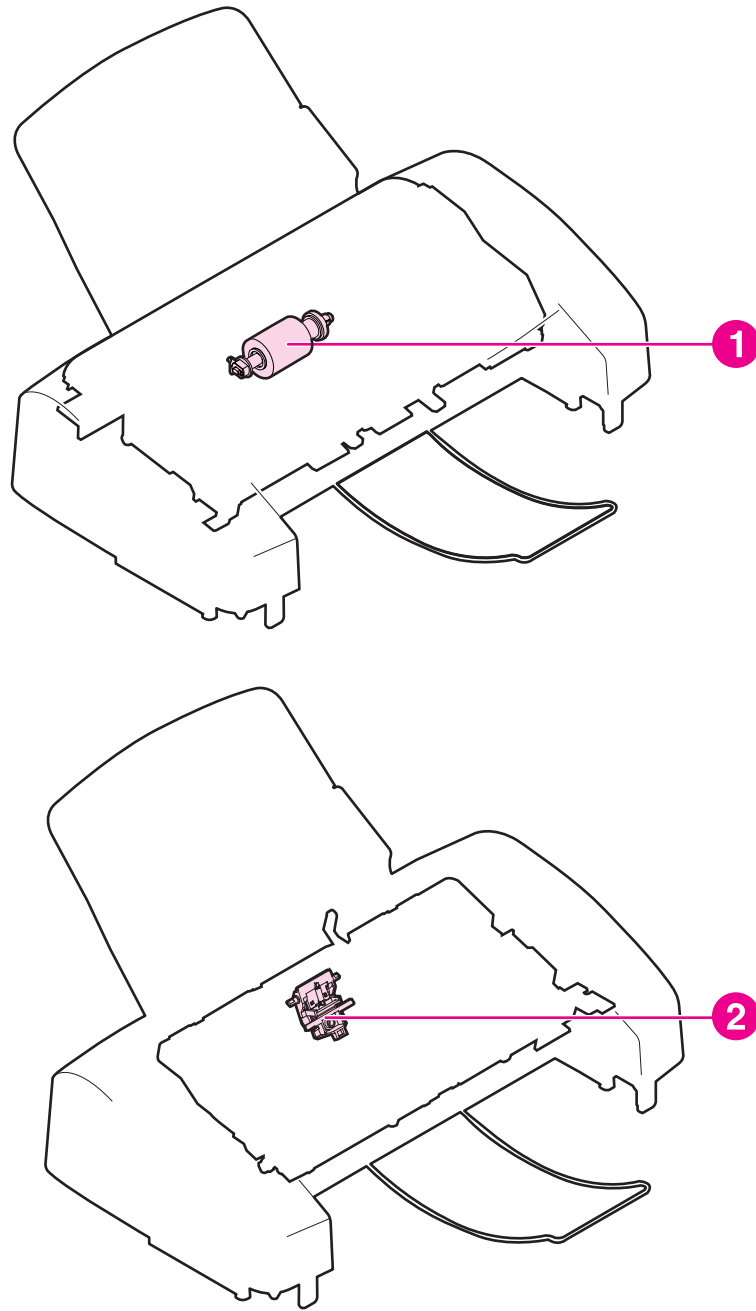
## Component locations, HP LaserJet 3015 all-in-one



**Figure 6-22.**

### **Major components**

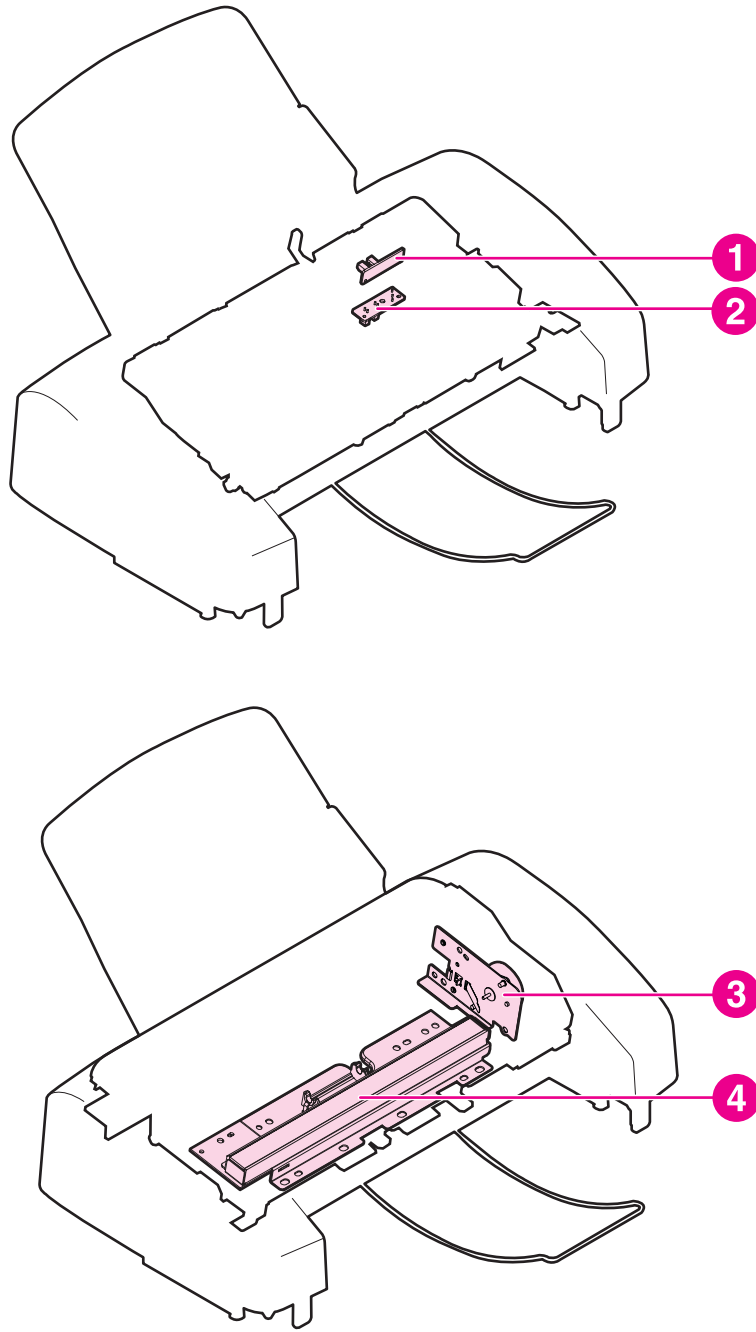
- 1 Guide assembly
- 2 Frame assembly



**Figure 6-23.**

**Main parts**

- 1 Pickup roller
- 2 Separation pad assembly

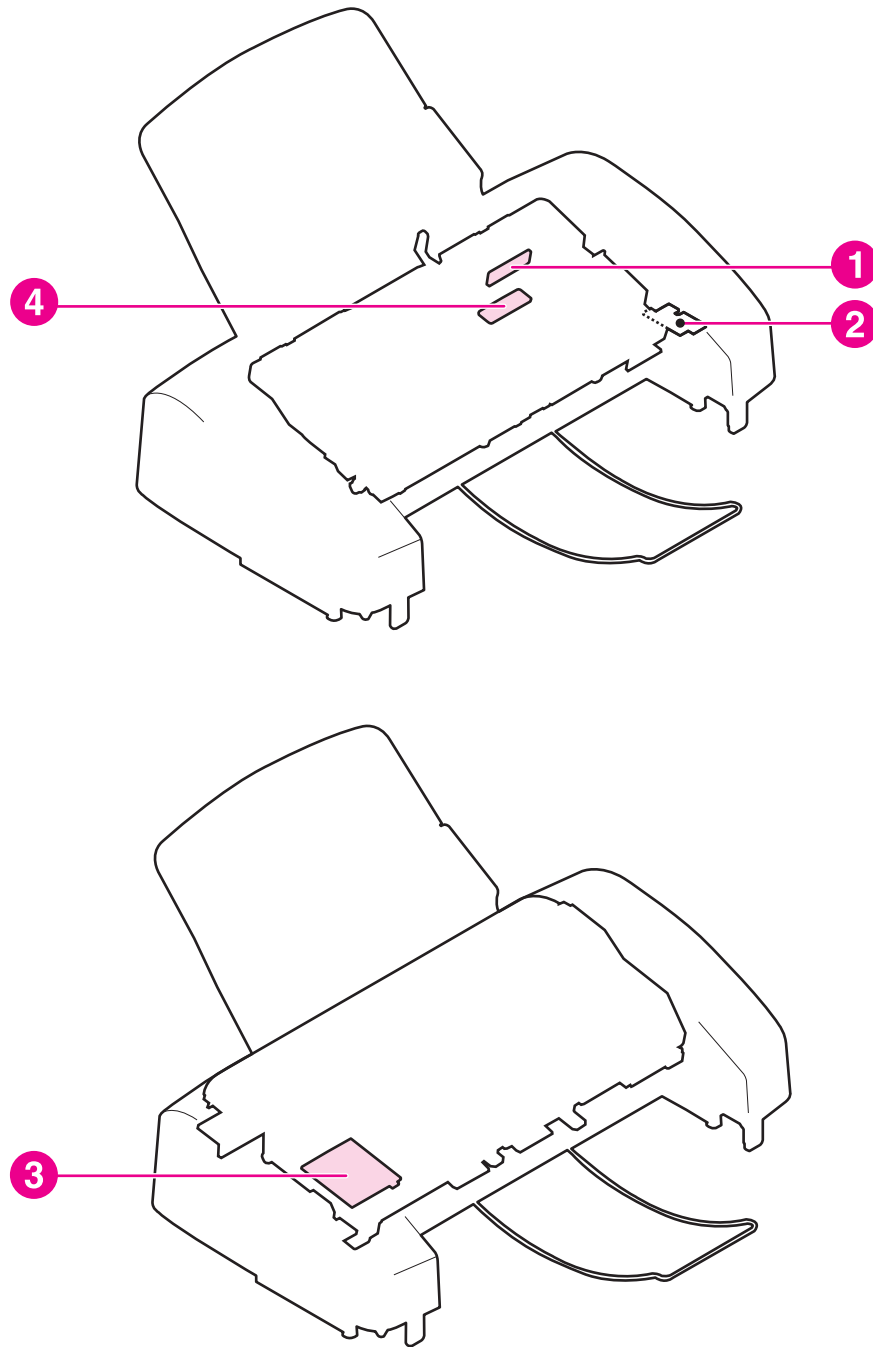


**Figure 6-24.**

**Sensors and motors**

- 1 Document sensor
- 2 Document-top sensor
- 3 Scanner-assembly motor
- 4 Contact image sensor



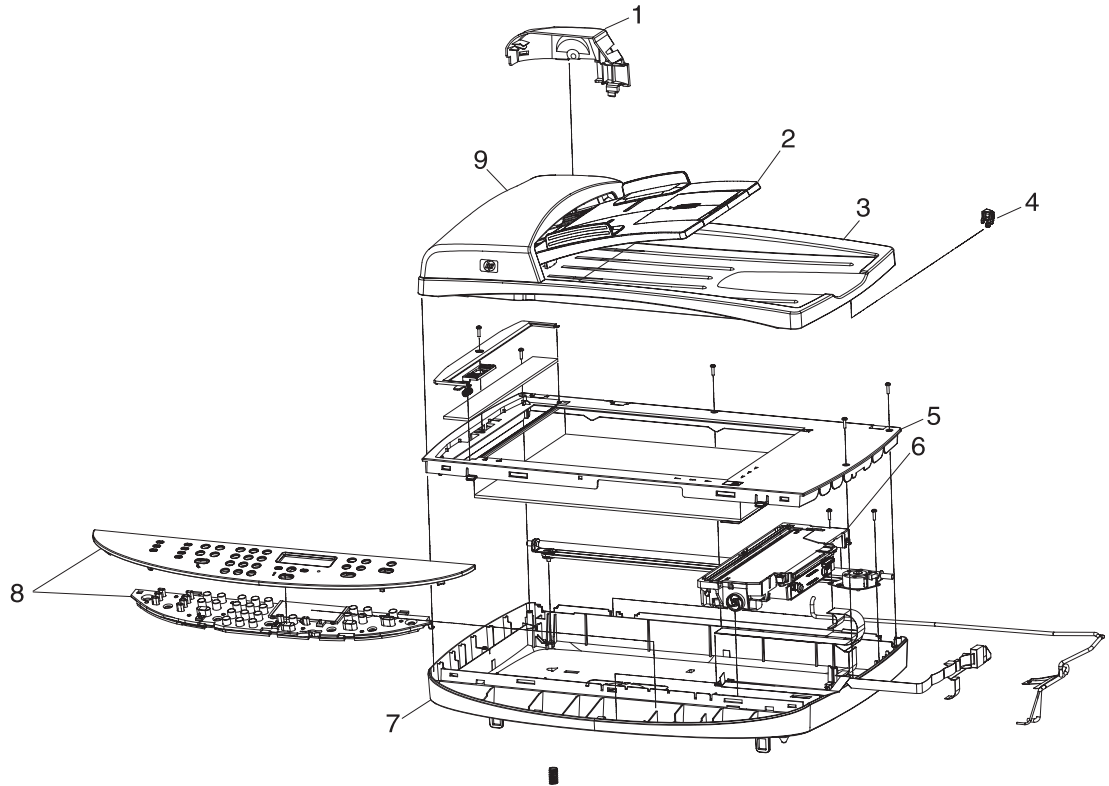


**Figure 6-25.**

**PCBs**

- 1 Document-sensor PCB
- 2 Grounding-connector PCB
- 3 CIS filter PCB
- 4 Document-top sensor PCB

## Component locations, HP LaserJet 3020 and 3030 all-in-one

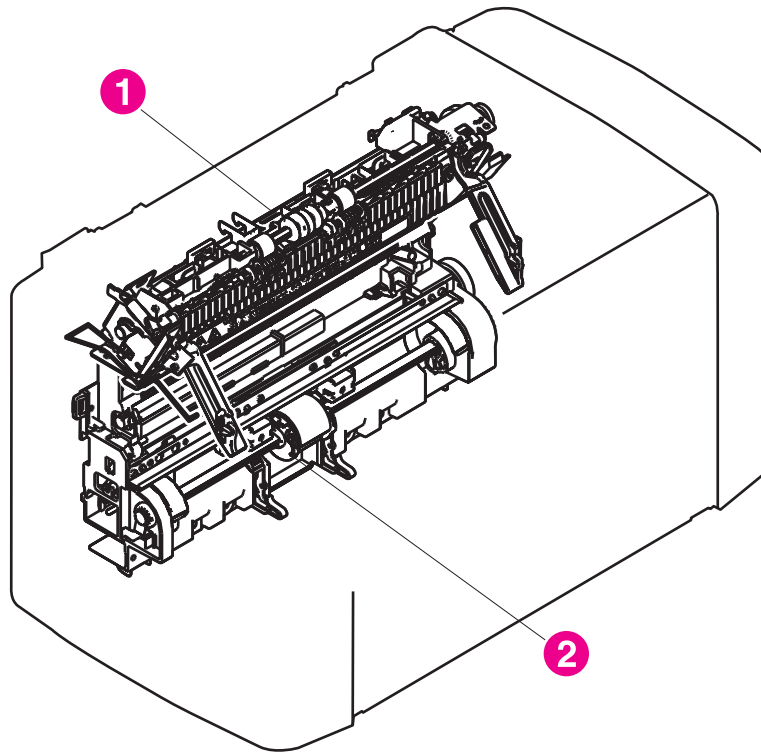


**Figure 6-26.**

### **HP LaserJet 3020 and 3030 components**

- 1 ADF motor cover (under the ADF lid)
- 2 ADF input tray
- 3 Flatbed scanner lid and ADF output bin
- 4 ADF solar lock (hinge locking clip)
- 5 Flatbed (with glass)
- 6 CCD scanner assembly
- 7 Scanner bed
- 8 Control-panel assembly
- 9 ADF assembly (includes the ADF lid, ADF pickup roller, and ADF separation pad assembly)

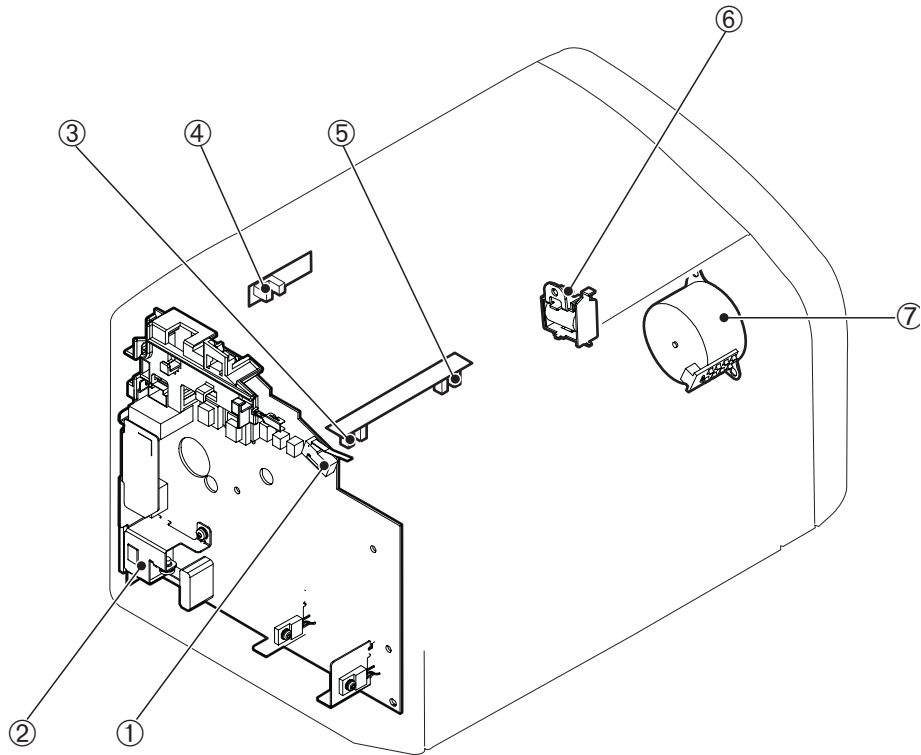
## Component locations, HP LaserJet 3015, 3020 and 3030 printer (product base)



**Figure 6-27.**

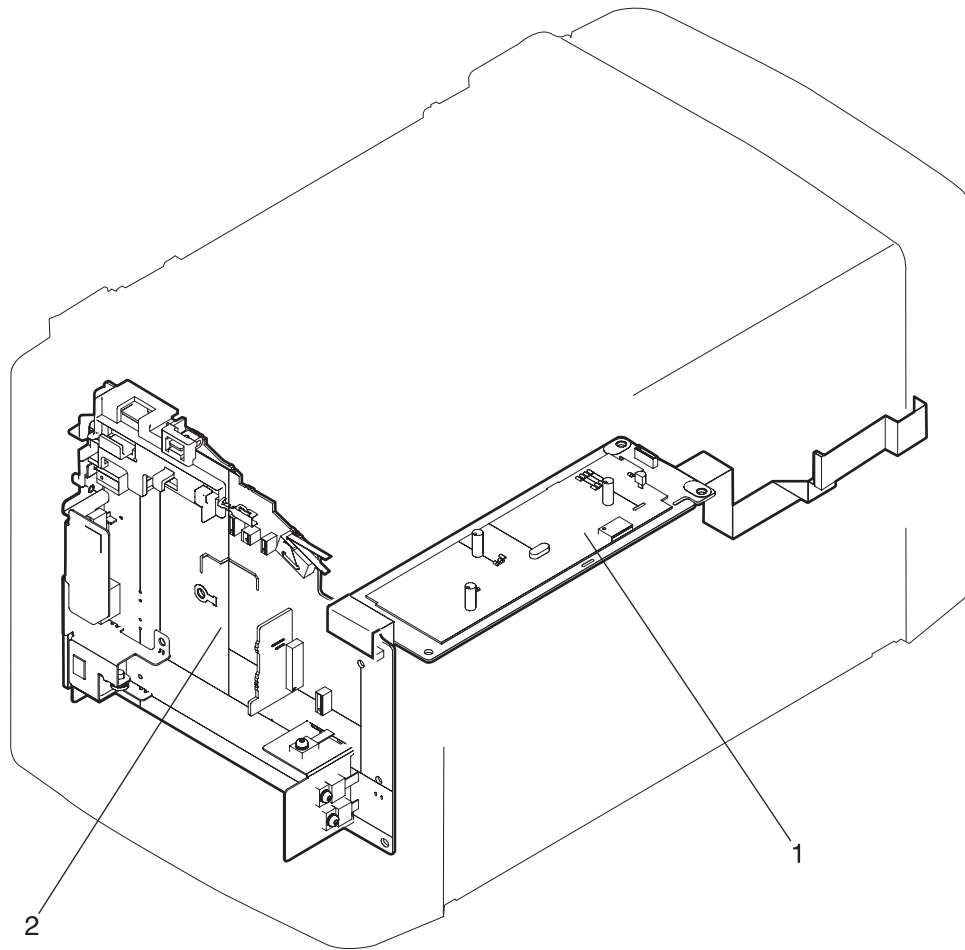
### **Major components**

- 1 Fuser assembly
- 2 Paper-pickup assembly



**Figure 6-28. Solenoid, sensors, switches, and motor**

- 1 Print-cartridge-door switch
- 2 Power switch/power supply
- 3 Paper-width sensor
- 4 Paper-delivery sensor
- 5 Top-of-page sensor
- 6 Solenoid
- 7 Motor



**Figure 6-29.**

**PCBs**

- 1 Engine controller unit (ECU)
- 2 Formatter

---

**Note**

For the HP LaserJet 3015 and 3030, the line interface unit (LIU) is attached to the formatter. The HP LaserJet 3020 does not have fax capabilities, and does not use an LIU.

---



# 7

## Parts and diagrams

This chapter contains the following sections.

Ordering parts and supplies .....	282
Parts that wear .....	282
Parts .....	282
World-wide customer support .....	282
Accessories .....	284
Common hardware .....	284
How to use the parts lists and diagrams .....	285
HP LaserJet 3015 scanner assembly .....	286
HP LaserJet 3020/3030 scanner assembly .....	296
HP LaserJet 3015/3020/3030 printer base.....	304

# Ordering parts and supplies

## Parts that wear

The parts on the product that wear are listed in [Life expectancies of parts that wear](#) in [Table 3-1. Life expectancies of parts that wear](#). Parts are available directly from Hewlett-Packard at the following URL: <http://partsdirect.hp.com>.

## Parts

Order replacement parts from the following website: <https://partsdirect.hp.com/epdo/default/mainmenu.asp>

## World-wide customer support

Order documentation and software from the websites listed in [Table 7-1. Technical support websites and related documentation](#):

**Table 7-1. Technical support websites and related documentation**

<b>HP Connect Online</b> (for HP partners)	<a href="http://www.connect-online.hp.com">http://www.connect-online.hp.com</a>
<b>HP Customer Care Call Centers</b> Information for contacting HP call centers in specific countries/regions.	<a href="http://www.hp.com/support/callcenters">http://www.hp.com/support/callcenters</a>
<b>HP Online Technical Support</b> Software drivers, support documentation, and answers to frequently asked questions	<a href="http://www.hp.com/support">http://www.hp.com/support</a>
<b>HP Technical Training (North America)</b> Classes and schedules	<a href="http://www.compaq.com/training">http://www.compaq.com/training</a>  Note: Select your country/region in the "select a country or region" field at the top, right corner of the page.
<b>Parts</b> Parts information	<a href="http://partsurfer.hp.com">http://partsurfer.hp.com</a>



**Table 7-1. Technical support websites and related documentation (continued)**

<p><b>Fax guide</b></p>	<ul style="list-style-type: none"><li>● <b>Q2660-90920</b> English, Spanish (Castilian), and Portuguese (Brazilian)</li><li>● <b>Q2660-90921</b> English, French (European), German, and Dutch</li><li>● <b>Q2660-90924</b> English, Russian, Turkish, and Arabic</li><li>● <b>Q2660-90925</b> English, Korean, Simplified Chinese, and Thai</li><li>● <b>Q2660-90926</b> English, Traditional Chinese, Indonesian (Bahasa), and Vietnamese</li><li>● <b>Q2660-90928</b> English, Italian, Spanish (Castilian), and Portuguese (Brazilian)</li><li>● <b>Q2660-90929</b> English, Finnish, and Swedish</li><li>● <b>Q2660-90930</b> English, Danish, and Norwegian</li><li>● <b>Q2660-90931</b> English, Hungarian, and Polish</li><li>● <b>Q2660-90932</b> English, Hebrew, and Greek</li><li>● <b>Q2660-90933</b> English and French (European)</li><li>● <b>Q2660-90934</b> English, Czech, and Slovak</li></ul>
-------------------------	--

## Accessories

The following accessories are available for the HP LaserJet 3015, 3020, and 3030 products.

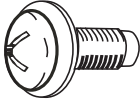
**Table 7-2. Accessories**

Product name	Description	Part number
Print cartridge	2,000-page cartridge	Q2612A
Toner cloth	Ideal for wiping up toner spills	5090-3379
Scanner hinge tool	Use this tool to keep the scanner assembly from falling off of the printer when the entire assembly is being removed.	5185-7441
Fax telephone cord	2-wire 3-meter (9.8-foot) fax telephone cord	8121-0811
Parallel cable	2-meter (6.6-foot) IEEE-1284 parallel cable	C2950A
Parallel cable	3-meter (9.8-foot) IEEE-1284 parallel cable	C2951A
USB cable	2-meter (6.6-foot) USB cable	8121-0539
USB cable	0.6-meter (2-foot) USB cable	8121-0549
Power cord 1.8-meter (6 feet)	U.S./Canada	8120-8382
Power cord 1.8-meter (6 feet)	Europe	8121-0516
Power cord 1.8-meter (6 feet)	UK	8121-0517
Power cord 1.8-meter (6 feet)	Danish	8121-0518
Power cord 1.8-meter (6 feet)	Switzerland	8121-0519
Power cord 1.8-meter (6 feet)	South America	8121-0520
Power cord 1.8-meter (6 feet)	Israel	8121-0521

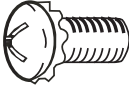


## Common hardware

The product has three common fasteners. See [Table 7-3. Common fasteners](#) for a description of these screw types.

**Table 7-3. Common fasteners**

Example	Description
	Screw, machine, truss head

**Table 7-3. Common fasteners (continued)**

Example	Description
 A line drawing of a star-shaped screw with a six-pointed star head and a threaded shaft.	Screw, star
 A line drawing of a self-tapping screw with a Phillips head and a threaded shaft.	Screw, self-tapping
 A line drawing of a Torx screw with a cross-shaped head and a threaded shaft.	Screw, torx

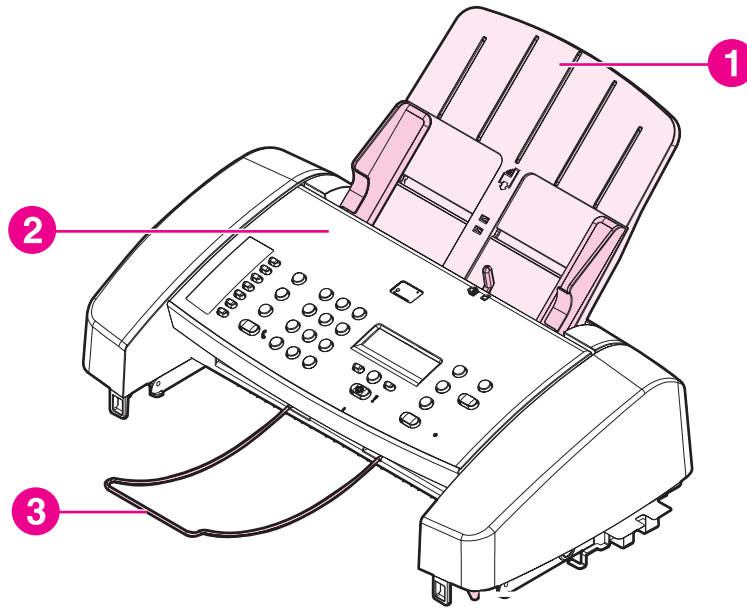
## How to use the parts lists and diagrams

The figures in this chapter illustrate the major subassemblies in the product and their component parts. A table (material list) follows each exploded assembly diagram. Each table lists the reference designator, the associated part number for the item, and a description of the part.

Parts that have no reference designator or part number are not field-replaceable units (FRUs) and cannot be ordered.

While looking for a part number, pay careful attention to the voltage listed in the description column to make sure that the part number selected is for the correct product model.

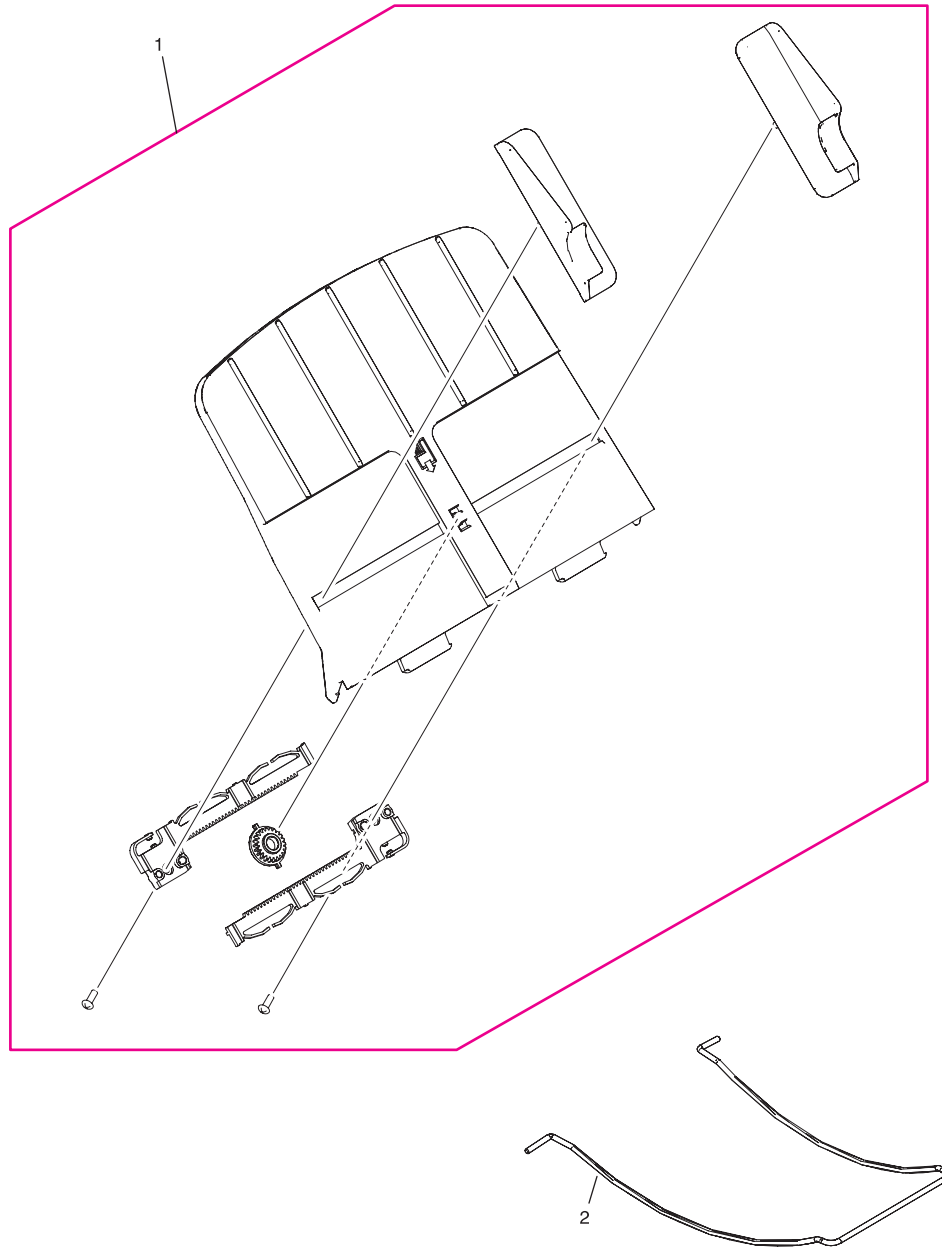
## HP LaserJet 3015 scanner assembly



**Figure 7-1.** HP LaserJet 3015

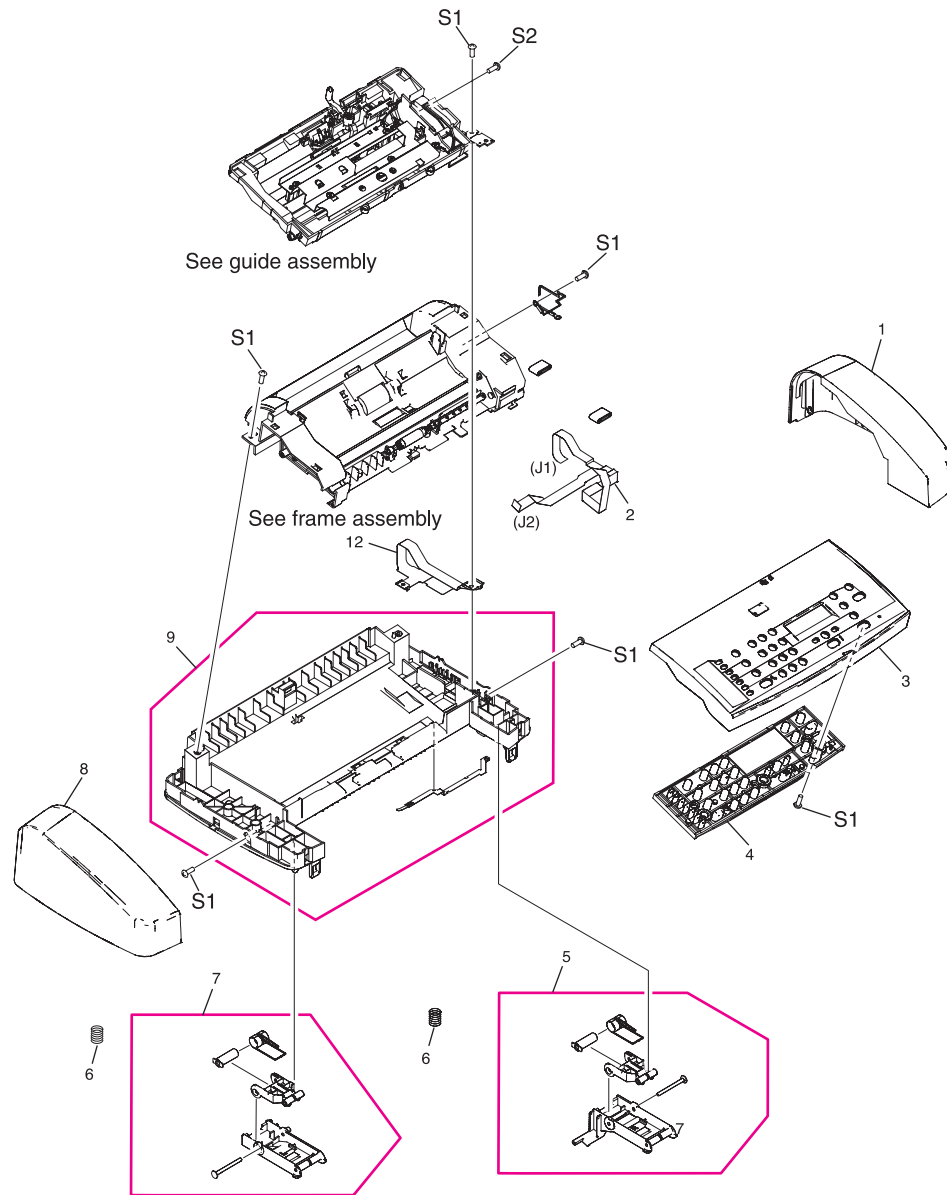
Ref	Description	Part number	Qty
1	HP LaserJet 3015 scanner assembly	NA	
2	Scanner control panel assembly	RK2-0232-000CN	
3	Scanner tray, delivery (wire)	RC1-2560-000CN	1
Not shown	LJ3015 formatter <sup>LIU1</sup>	Q2668-60001	1

<sup>LIU1</sup>To order the line interface unit (LIU) or print cartridge, see [HP LaserJet 3015/3020/3030 printer base](#),



**Figure 7-2.** ADF input and delivery assemblies (HP LaserJet 3015)

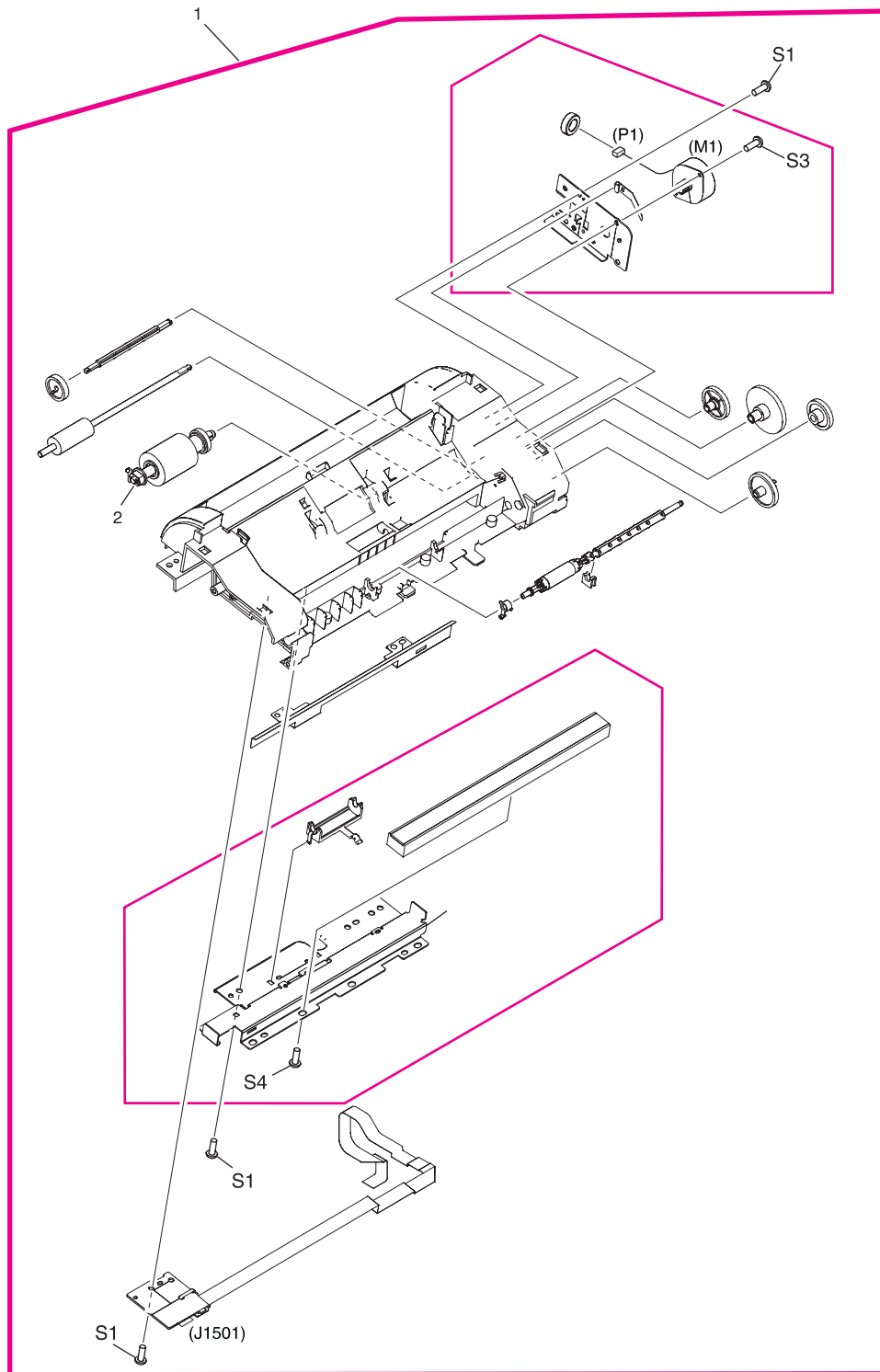
<b>Ref</b>	<b>Description</b>	<b>Part number</b>	<b>Qty</b>
1	Scanner pickup tray assembly	RM1-0893-000CN	1
2	Scanner tray, delivery (wire)	RC1-2560-000CN	1



**Figure 7-3.** Internal components (HP LaserJet 3015)

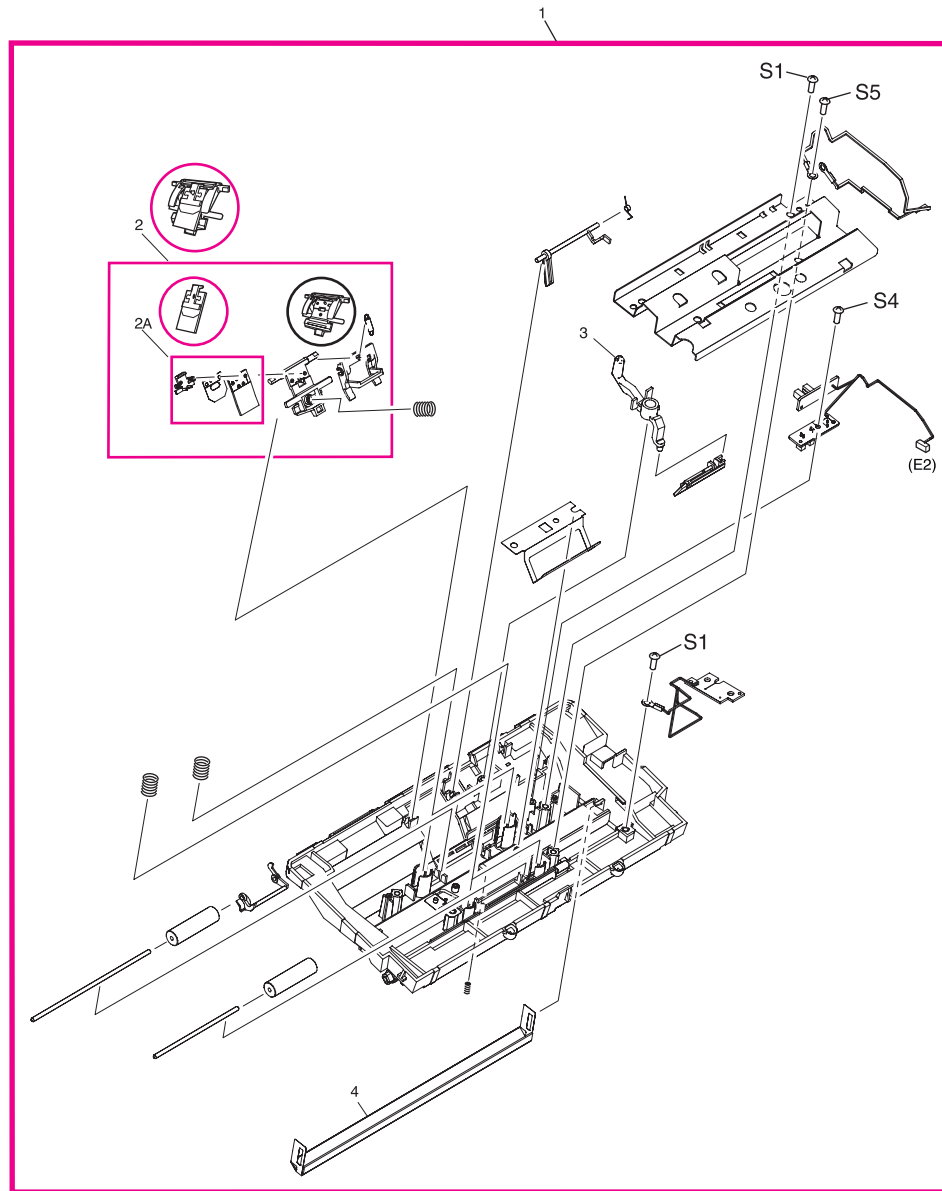


<b>Ref</b>	<b>Description</b>	<b>Part number</b>	<b>Qty</b>
1	Scanner cover, right	RC1-2559-000CN	1
2	Scanner flexible flat cable (FFC)	RK2-0236-000CN	1
3	Scanner cover top assembly	RC1-2564-000CN	1
NA	3015 English bezel	Q2669-40002	1
NA	Scanner control-panel overlay; French	Q2669-00001	1
NA	Scanner control-panel overlay; German	Q2669-00002	1
NA	Scanner control-panel overlay; Italian	Q2669-00003	1
NA	Scanner control-panel overlay; Spanish	Q2669-00004	1
NA	Scanner control-panel overlay; Danish	Q2669-00005	1
NA	Scanner control-panel overlay; Dutch	Q2669-00006	1
NA	Scanner control-panel overlay; Finnish	Q2669-00007	1
NA	Scanner control-panel overlay; Portuguese	Q2669-00008	1
NA	Scanner control-panel overlay; Swedish	Q2669-00009	1
NA	Scanner control-panel overlay; Czech	Q2669-00010	1
NA	Scanner control-panel overlay; Hungarian	Q2669-00011	1
NA	Scanner control-panel overlay; Polish	Q2669-00012	1
NA	Scanner control-panel overlay; Russian	Q2669-00013	1
NA	Scanner control-panel overlay; Slovak	Q2669-00014	1
NA	Scanner control-panel overlay; Turkish	Q2669-00015	1
NA	Scanner control-panel overlay; Arabic	Q2669-00016	1
NA	Scanner control-panel overlay; Norwegian	Q2669-00023	1
4	Scanner control-panel assembly	RK2-0232-000CN	
5	Scanner link assembly, right (HP LaserJet 3015)	RM1-0897-000CN	1
6	Scanner spring, compression	RU5-2198-000CN	2
7	Scanner link assembly, left (HP LaserJet 3015)	RM1-0896-000CN	1
8	Scanner cover, left	RC1-2358-000CN	1
9	Scanner base frame assembly (scanner support frame)	RL1-0375-000CN	1
10	Scanner sheet, grounding	RL1-0376-000CN	1
S1	Screw, tap M4X10	XB4-5401-009CN	6
S2	Screw, tap BH3X6	XA9-1503-000CN	1



**Figure 7-4.** Frame assembly (HP LaserJet 3015)

<b>Ref</b>	<b>Description</b>	<b>Part number</b>	<b>Qty</b>
1	LJ3015 scanner frame assembly	RM1-0883-000CN	1
2	LJ3015 scanner pickup assembly	RM1-0885-000CN	1
S1	Screw, tap M4X10	XB4-5401-009CN	3
S3	Screw, machine M3X6	XB1-2300-605CN	1
S4	Screw, w/washer M3X6	XB2-7300-605CN	1



**Figure 7-5.** Guide assembly (HP LaserJet 3015)

Ref	Description	Part number	Qty
1	Scanner guide assembly	RM1-0889-000CN	1
2	Scanner separation-pad assembly	RM1-0890-000CN	1
2A	Scanner separation pad set	RM1-0891-000CN	1
3	Scanner media lever (lever, pressure convert)	RC1-2543-000CN	1
Not shown	Scanner media lever torsion spring (lever, pressure convert)	RC1-2544-000CN	1
4	Scanner white platen	RF5-3235-000CN	1
Not shown	Compression spring (white platen)	RU5-2196-000CN	3
S1	Screw, tap M4X10	XB4-5401-009CN	2
S4	Screw, w/washer M3X6	XB2-7300-605CN	1
S5	Screw, rs M3X6	XA9-1495-000CN	1

---

**Note**

The *separation pad set* and the *separation pad assembly* are two different assemblies.

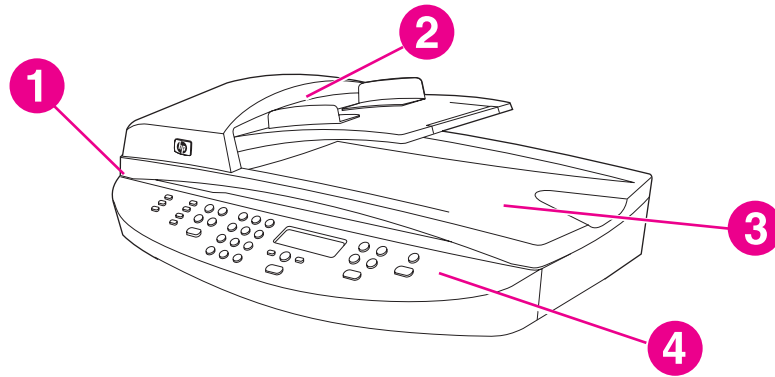
The separation pad set consists of the pad, clear plastic sheet, and the pad cover. The separation pad set *is* a user replaceable assembly.

The separation-pad assembly consists of the separation lever, tension spring, feed arm, and the components of the separation pad set. The separation-pad assembly *is not* a user replaceable assembly.

---

Only trained service personnel should attempt to replace the separation-pad assembly.

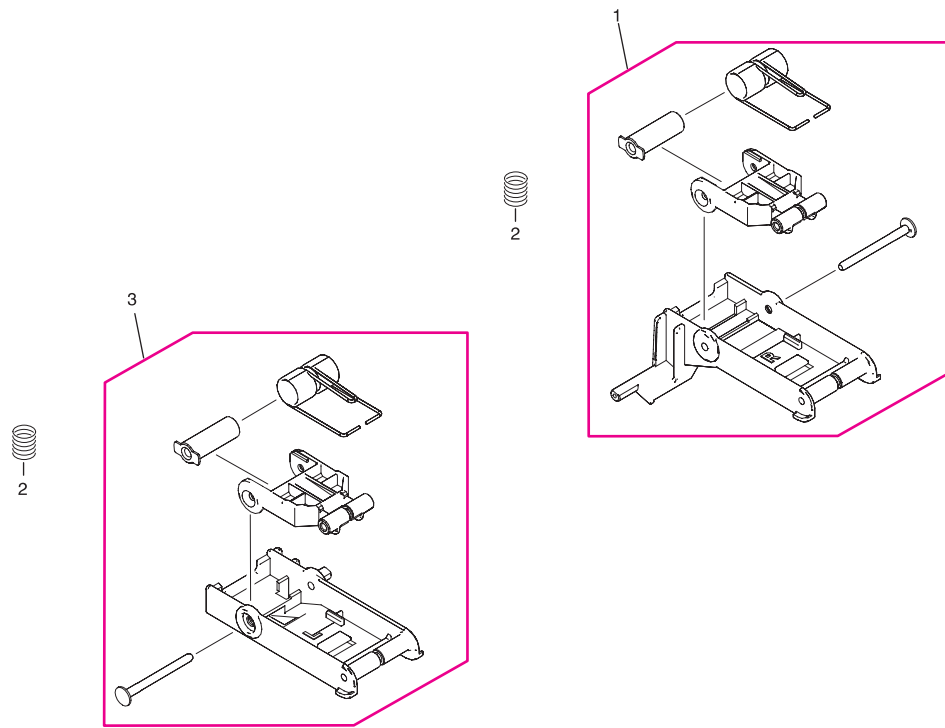
## HP LaserJet 3020/3030 scanner assembly



**Figure 7-6.** HP LaserJet 3020/3030 scanner assembly

Ref	Description	Part number	Qty
1	HP LaserJet 3020/3030 scanner assembly	NA	
2	Automatic document feeder and flatbed lid (ADF; part of the flatbed lid)	Q2665-60102-000CN	1
3	Flatbed scanner assembly	Q26665-60112-000CN	1
4	LJ3020 copy control panel	Q2665-60101	
4	LJ3030 fax control panel	Q2666-60101	
Not shown	LJ3020 formatter	C2688-60002	1
Not shown	LJ3030 formatter <sup>LIU2</sup>	Q2664-60001	1

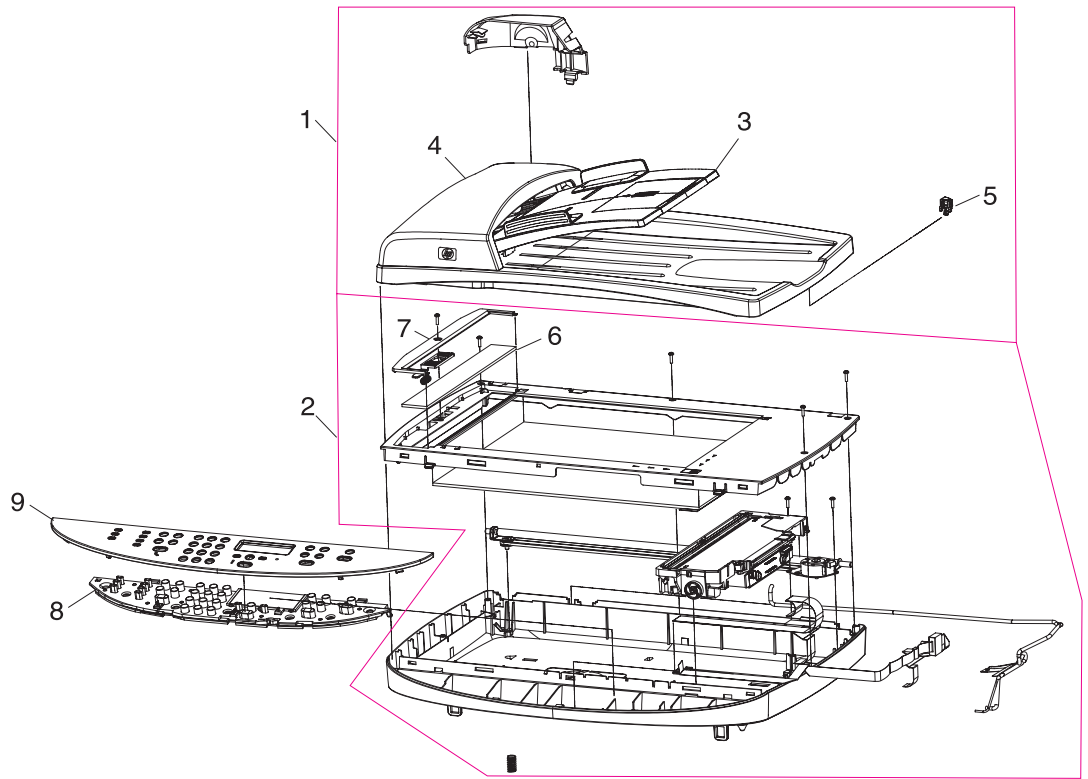
<sup>LIU2</sup>To order the line interface unit (LIU) or toner cartridge, see [HP LaserJet 3015/3020/3030 printer base](#).



**Figure 7-7.** Link assembly (HP LaserJet 3020/3030)



<b>Ref</b>	<b>Description</b>	<b>Part number</b>	<b>Qty</b>
1	LJ3020/3030 scanner link assembly right	RM1-0899-000CN	1
2	LJ3020/3030 scanner spring, compression	RU5-2199-000CN	2
3	LJ3020/3030 scanner link assembly left	RM1-0898-000CN	1



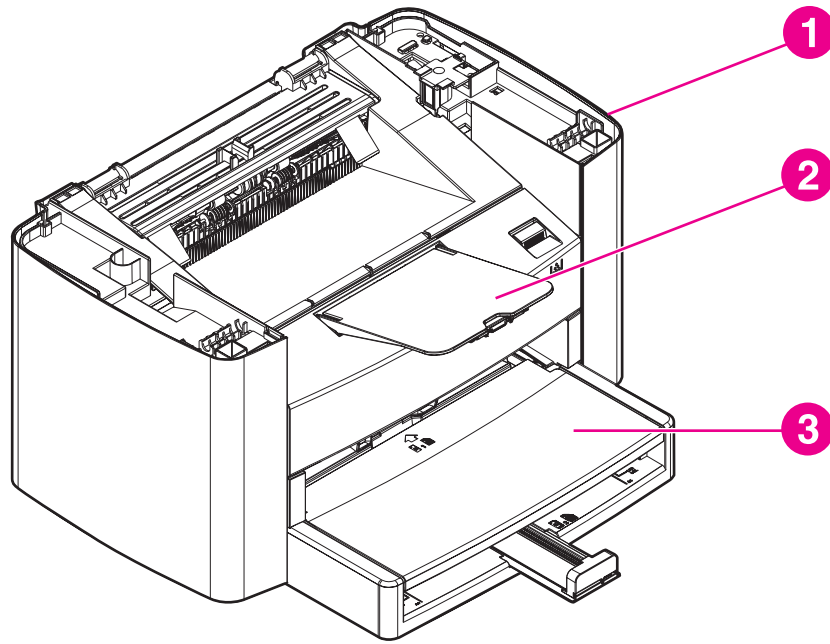
**Figure 7-8.** Major assemblies (HP LaserJet 3020/3030)

Ref	Description	Part number	Qty
1	ADF assembly and flatbed lid	Q2665-60102	1
2	Flatbed scanner assembly (does not include the flatbed lid)	Q2665-60112	1
Not shown	Separation pad	C7309-60009	1
3	ADF input tray	Q2665-60109	1
Not shown	ADF pickup-roller assembly	C7309-60016	1
Not shown	ADF cleanout/comb	C7309-40153	1
Not shown	ADF input-tray flag	C7309-40013	1
Not shown	ADF input-tray spring	C7309-80013	1
4	LJ3020/3030 ADF lid	Q26665-60102	1
5	LJ3020/3030 ADF solar lock (clip)	Q1636-40036	1
6	LJ3020/3020 ADF glass	C7296-00014	1
7	ADF glass frame	Q1636-40037	1
8	LJ3020 copy control panel	Q2665-60101	1
9	3020 bezel; English	Q2665-40010	1
9	3020 bezel; French	Q2665-40018	1
9	3020 bezel; German	Q2665-40019	1
9	3020 bezel; Italian	Q2665-40020	1
9	3020 bezel; Spanish	Q2665-40021	1
9	3020 bezel; Danish	Q2665-40022	1
9	3020 bezel; Dutch	Q2665-40023	1
9	3020 bezel; Finnish	Q2665-40024	1
9	3020 bezel; Portuguese	Q2665-40025	1
9	3020 bezel; Swedish	Q2665-40026	1
9	3020 bezel; Czech	Q2665-40027	1
9	3020 bezel; Hungarian	Q2665-40028	1
9	3020 bezel; Polish	Q2665-40029	1
9	3020 bezel; Russian	Q2665-40030	1
9	3020 bezel; Slovak	Q2665-40031	1
9	3020 bezel; Turkish	Q2665-40032	1

<b>Ref</b>	<b>Description</b>	<b>Part number</b>	<b>Qty</b>
9	3020 bezel; Arabic	Q2665-40033	1
9	3020 bezel; Greek	Q2665-40034	1
9	3020 bezel; Hebrew	Q2665-40035	1
9	3020 bezel; Korean	Q2665-40036	1
9	3020 bezel; Simplified Chinese	Q2665-40037	1
9	3020 bezel; Traditional Chinese	Q2665-40038	1
9	3020 bezel; Thai	Q2665-40039	1
9	3020 bezel; Norwegian	Q2665-40040	1
9	3020 bezel; Swiss German	Q2665-40042	1
9	3020 bezel; Vietnamese	Q2665-40043	1
8	LJ3030 fax control panel	Q2666-60101	1
9	3030 bezel; English	Q2666-40002	1
9	3030 bezel; French	Q2666-40003	1
9	3030 bezel; German	Q2666-40004	1
9	3030 bezel; Italian	Q2666-40005	1
9	3030 bezel; Spanish	Q2666-40006	1
9	3030 bezel; Danish	Q2666-40007	1
9	3030 bezel; Dutch	Q2666-40008	1
9	3030 bezel; Finnish	Q2666-40009	1
9	3030 bezel; Portuguese	Q2666-40010	1
9	3030 bezel; Swedish	Q2666-40011	1
9	3030 bezel; Czech	Q2666-40012	1
9	3030 bezel; Hungarian	Q2666-40013	1
9	3030 bezel; Polish	Q2666-40014	1
9	3030 bezel; Russian	Q2666-40015	1
9	3030 bezel; Slovak	Q2666-40016	1
9	3030 bezel; Turkish	Q2666-40017	1
9	3030 bezel; Arabic	Q2666-40018	1
9	3030 bezel; Greek	Q2666-40019	1
9	3030 bezel; Hebrew	Q2666-40020	1
9	3030 bezel; Korean	Q2666-40021	1
9	3030 bezel; Simplified Chinese	Q2666-40022	1
9	3030 bezel; Traditional Chinese	Q2666-40023	1

<b>Ref</b>	<b>Description</b>	<b>Part number</b>	<b>Qty</b>
9	3030 bezel; Norwegian	Q2666-40025	1
9	3030 bezel; Swiss German	Q2666-40027	1

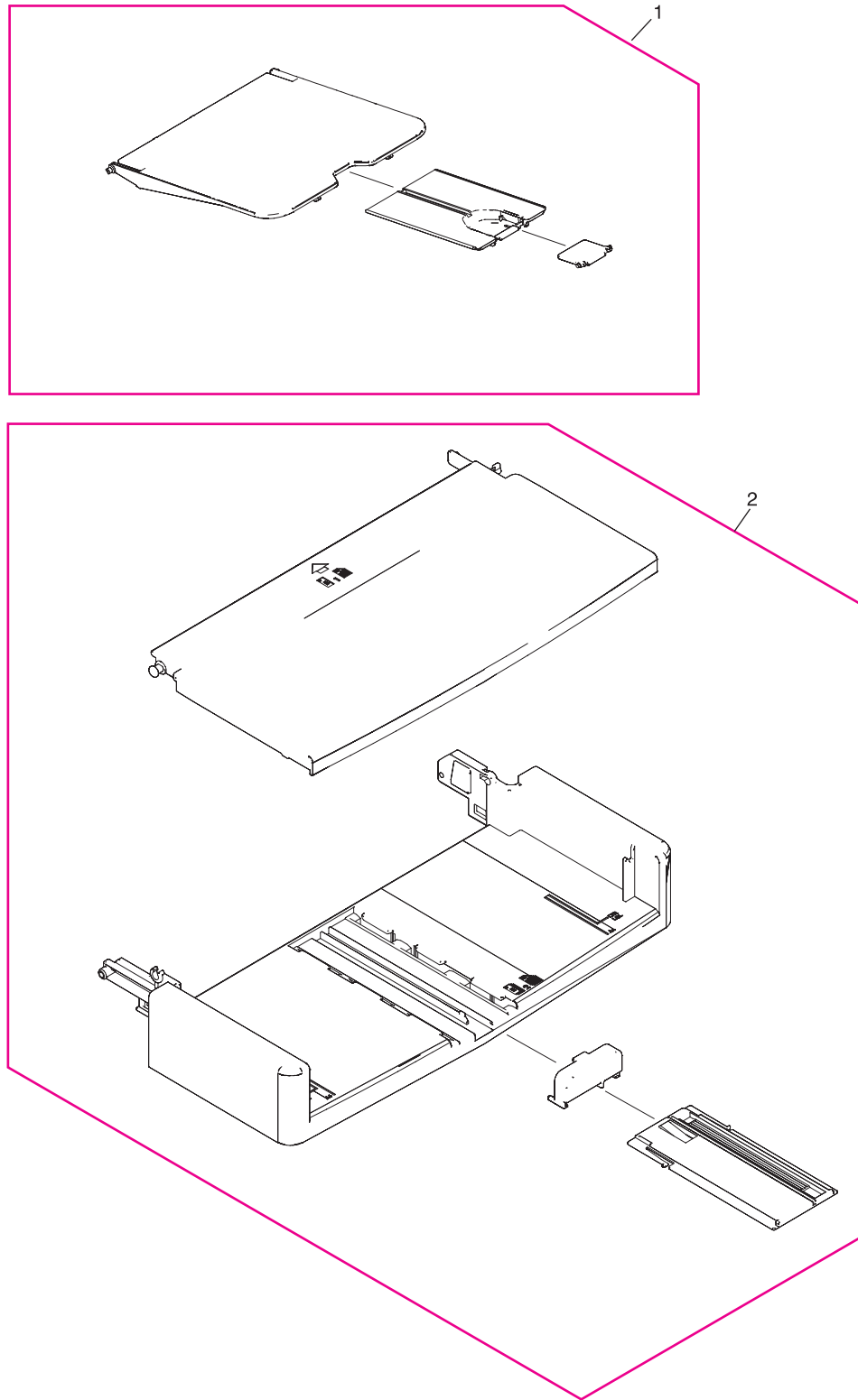
## HP LaserJet 3015/3020/3030 printer base



**Figure 7-9.** HP LaserJet 3015/3020/3030 printer base

Ref	Description	Part number	Qty
1	3015/20/30 print engine <sup>printer</sup> , replacement 110 V	Q2665-67001	
1	3015/20/30 print engine <sup>printer</sup> , replacement 220 V	Q2665-67002	
2	Delivery tray assembly	RM1-0859-000CN	
3	Pickup tray assembly	RM1-0858-000CN	
Not shown	US/WW LIU (Line interface unit)	Q2663-60001	
Not shown	EMEA LIU (Line interface unit)	Q2687-60002	
Not shown	Print cartridge	Q2460-67913	
NA	HP jewel	7121-8043	

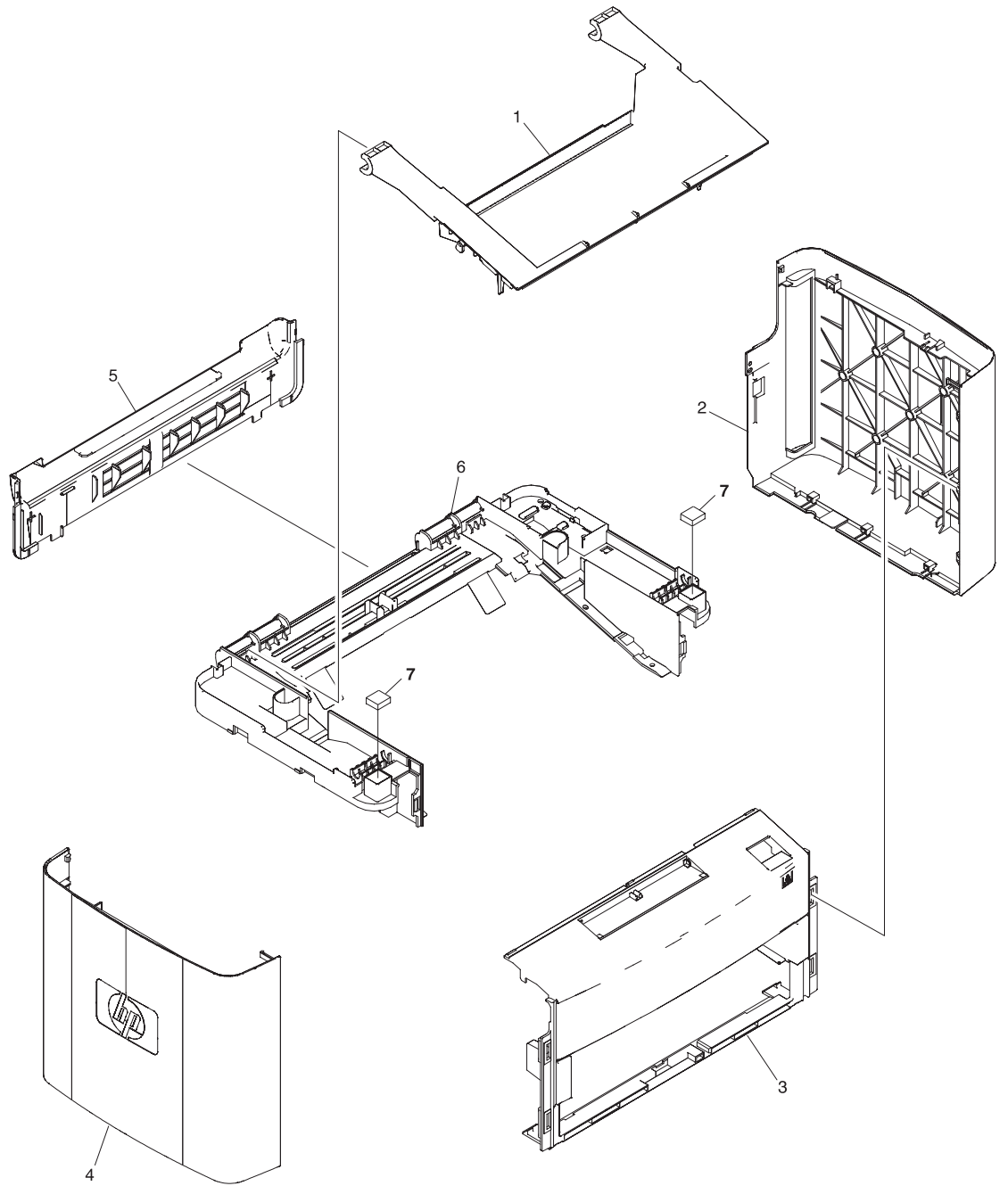
<sup>printer</sup>The HP LaserJet 3015/3020/3030 printer base (reference items 1 or 2) *does not* come with all of the covers and printed circuit assemblies that are required to make it a functioning unit. Components from the unit that is being serviced must be installed onto the replacement printer base.



**Figure 7-10.** Pickup and delivery tray assemblies (LJ 3015/3020/3030 printer base)

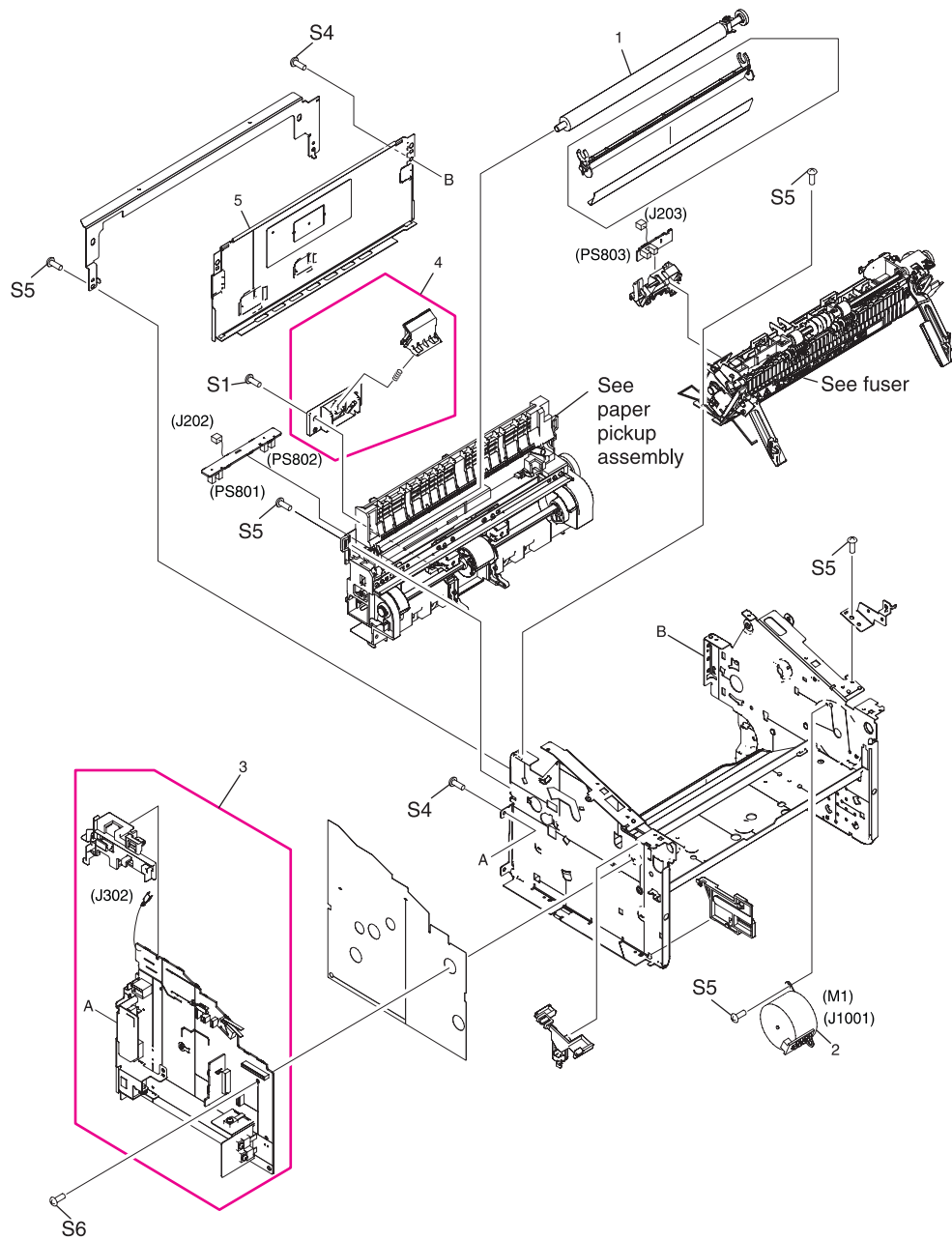


<b>Ref</b>	<b>Description</b>	<b>Part number</b>	<b>Qty</b>
1	Delivery-tray assembly (product output bin)	RM1-0859-000CN	1
2	Pickup-tray assembly (media input tray)	RM1-0858-000CN	1



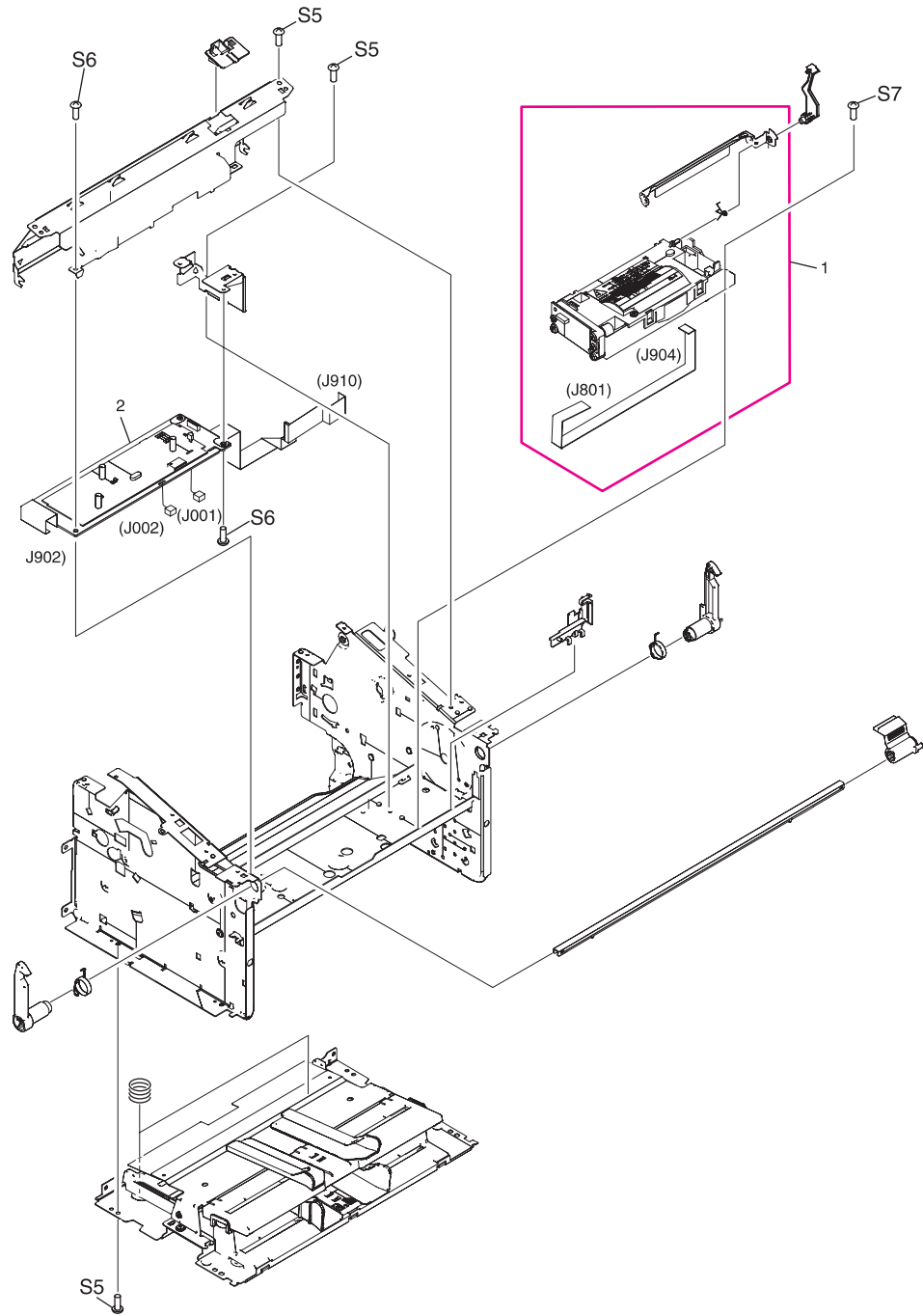
**Figure 7-11.** External covers (LJ 3015/3020/3030 printer base)

<b>Ref</b>	<b>Description</b>	<b>Part number</b>	<b>Qty</b>
1	Door, print cartridge	RC1-2473-000CN	1
2	Cover, right	RC1-2472-000CN	1
3	Cover, front	RL1-0358-000CN	1
4	Cover, left	RC1-2471-000CN	1
5	Cover, rear	RC1-2474	1
6	Cover, top (scanner support frame), printer	RL1-0359-000CN	1
7	Scanner cushion	RC1-2476-000CN	2



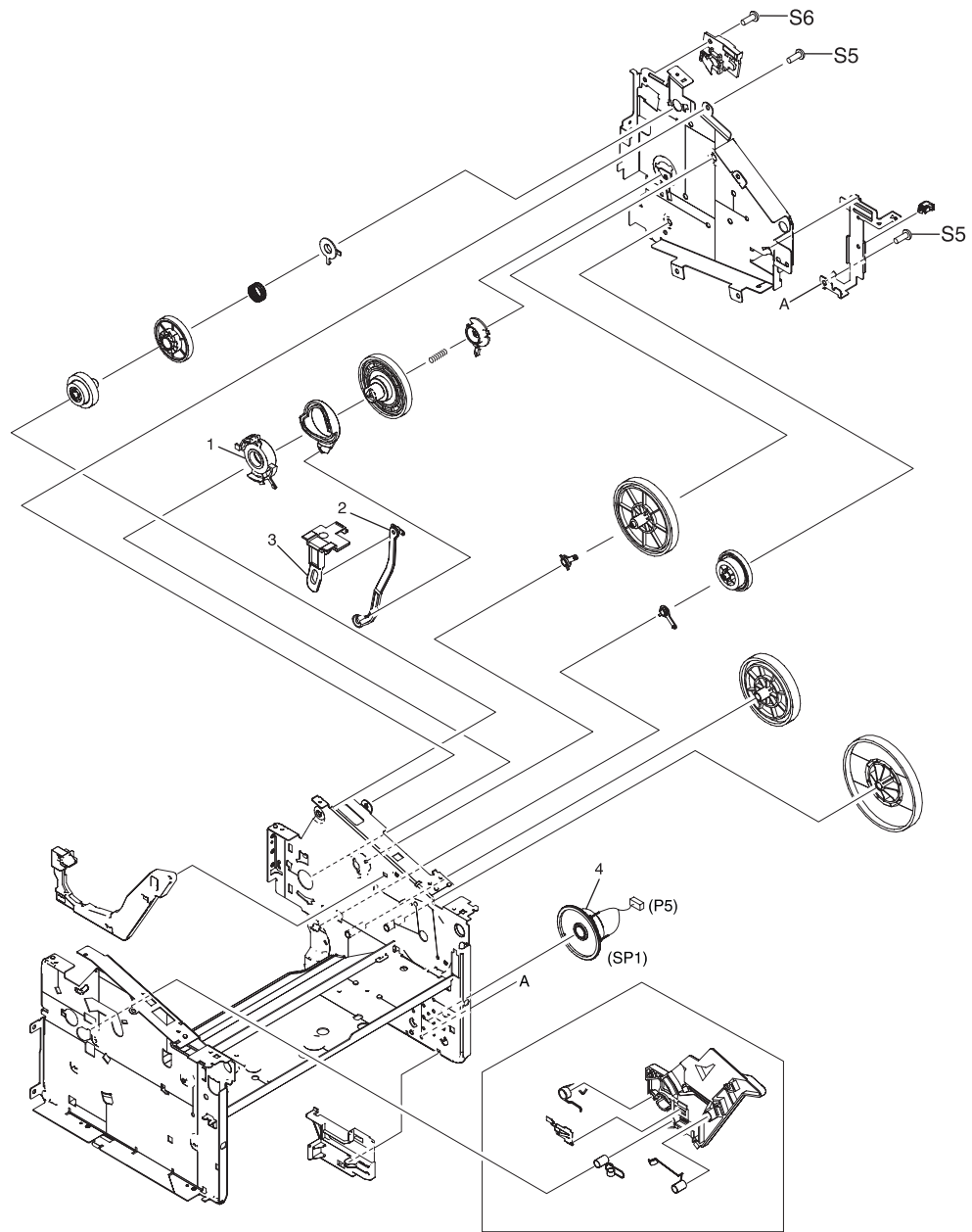
**Figure 7-12.** Internal components 1 of 1 (LJ 3015/3020/3030 printer base)

<b>Ref</b>	<b>Description</b>	<b>Part number</b>	<b>Qty</b>
1	Transfer-roller assembly	RM1-0658-000CN	1
2	Motor, stepping	RK2-0107-000CN	1
3	Power-supply assembly, 110-127 V	RM1-0903-000CN	1
3	Power-supply assembly, 220-240 V	RM1-0904-000CN	1
4	Separation-pad assembly, printer	RM1-0648-000CN	1
5	Panel, rear	RC1-1985-000CN	1
S1	Screw, tap M4X10	XB4-5401-009CN	1
S4	Screw, w/washer M3X6	XB2-7300-605CN	2
S5	Screw, rs M3X6	XA9-1495-000CN	5
S6	Screw, rs M3X8	XA9-1420-000CN	1



**Figure 7-13.** Internal components 2 of 2 (LJ 3015/3020/3030 printer base)

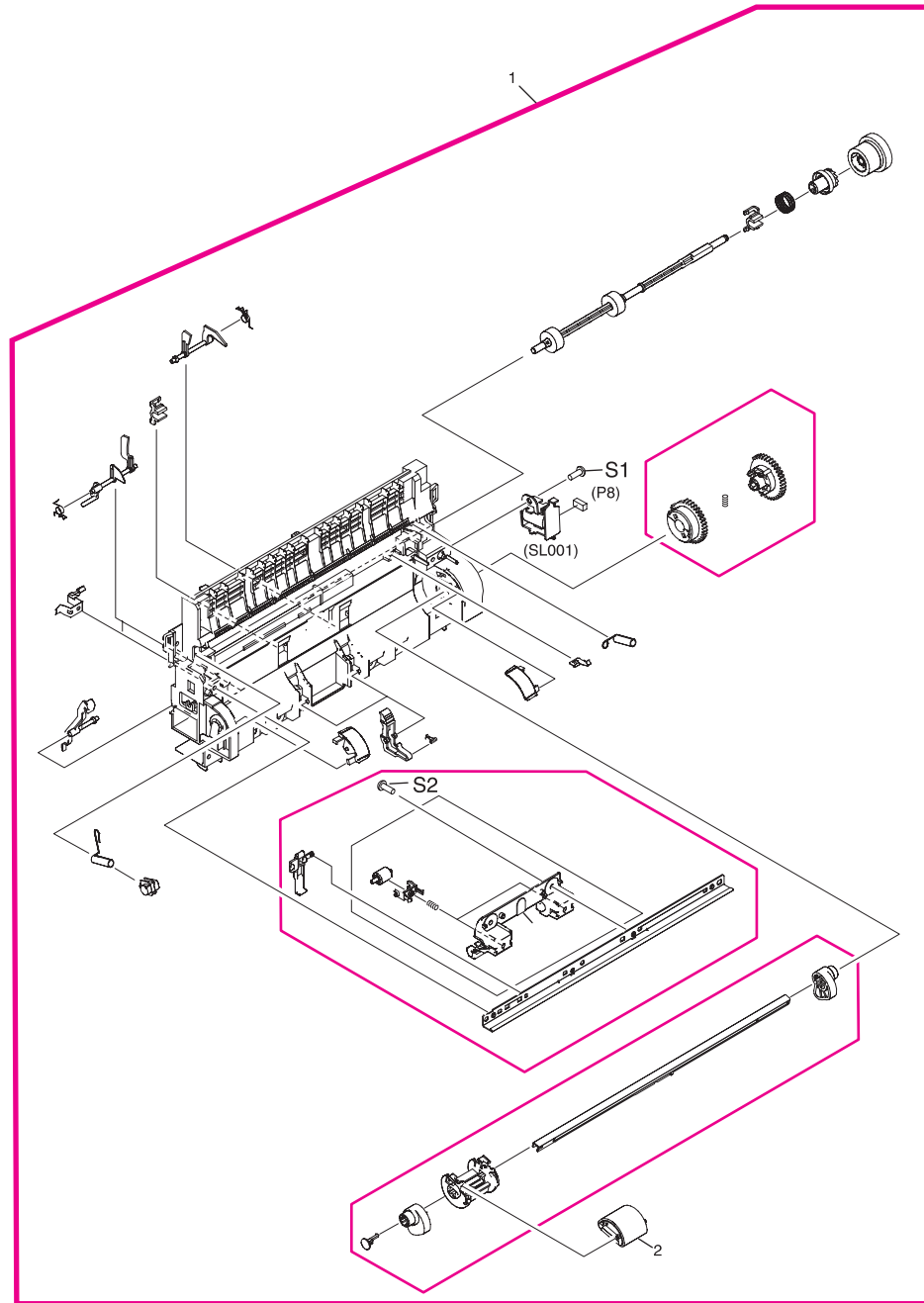
<b>Ref</b>	<b>Description</b>	<b>Part number</b>	<b>Qty</b>
1	Laser/scanner assembly	RM1-0171-000CN	1
2	Engine-controller-PCB assembly	RM1-0907-000CN	1
S5	Screw, rs M3X6	XA9-1495-000CN	3
S6	Screw, rs M3X8	XA9-1420-000CN	2
S7	Screw, rs M2X10	XA9-1501-000CN	1



**Figure 7-14.** Internal components 3 of 3 (LJ 3015/3020/3030 printer base)

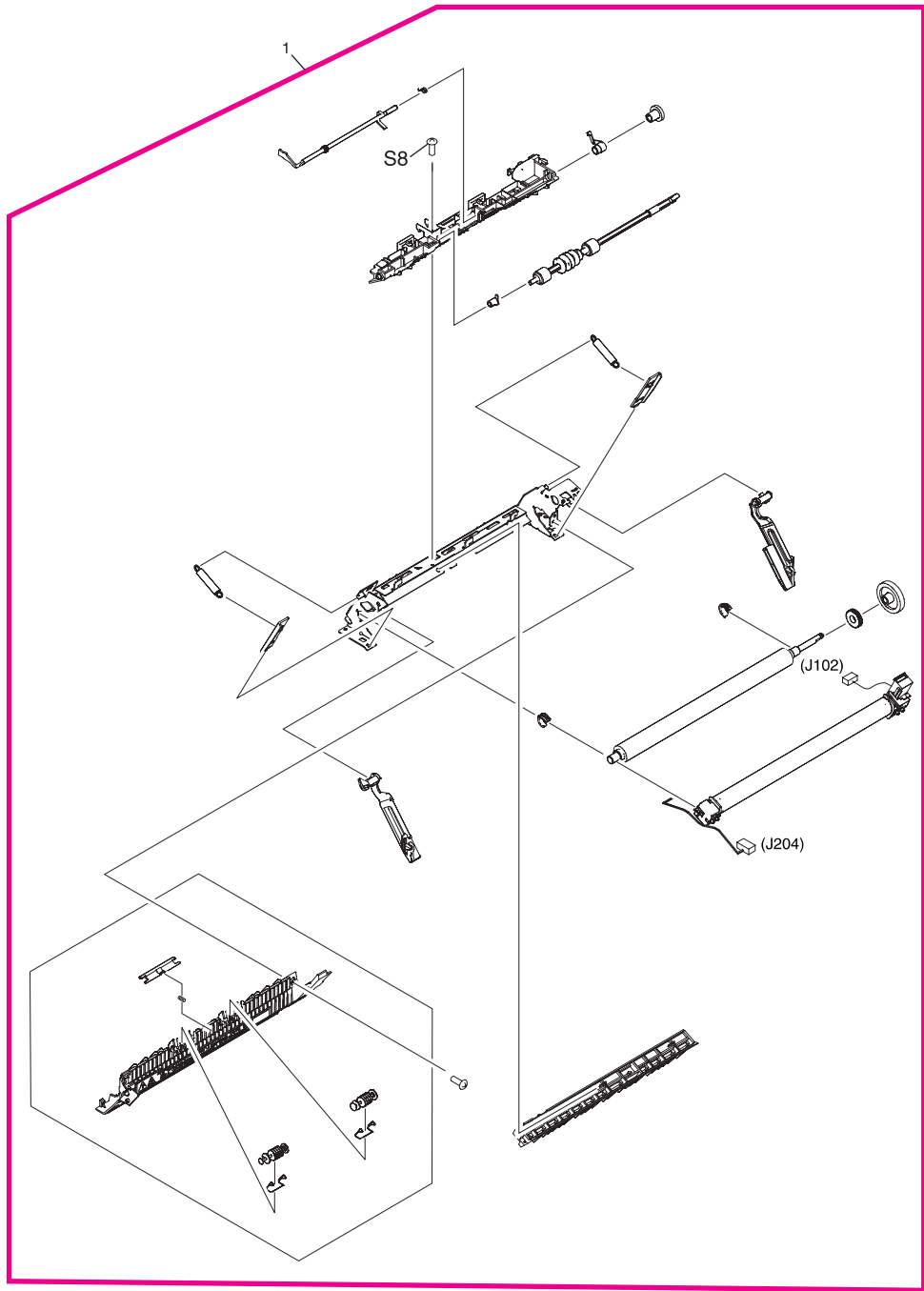


<b>Ref</b>	<b>Description</b>	<b>Part number</b>	<b>Qty</b>
1	Bushing	RC1-1953-000CN	1
2	Link, coupling lower	RC1-2485-000CN	1
3	Link, coupling top	RC1-2494-000CN	1
4	Speaker assembly	RM1-0915-000CN	1
S5	Screw, rs M3X6	XA9-1495-000CN	2
S6	Screw, rs M3X8	XA9-1420-000CN	1



**Figure 7-15.** Paper-pickup assembly (LJ 3015/3020/3030 printer base)

<b>Ref</b>	<b>Description</b>	<b>Part number</b>	<b>Qty</b>
1	Paper-pickup assembly	RM1-0864-000CN	1
2	Roller, pickup	RL1-0266-000CN	1
S1	Screw, tap M4X10	XB4-5401-009CN	1
S2	Screw, tap BH3X8	XA9-1503-000CN	1



**Figure 7-16.** Fuser (fixing assy) assembly (LJ 3015/3020/3030 printer base)

<b>Ref</b>	<b>Description</b>	<b>Part number</b>	<b>Qty</b>
1	Fuser (fixing assy) assembly 110-127 V	RM1-0862-000CN	1
1	Fuser (fixing assy) assembly 220-240 V	RM1-0863-000CN	1
S8	Screw, w/washer M3X6	XB2-8300-909CN	1

## Alphabetical parts list

**Table 7-4. Alphabetical parts list**

Description	Part number	Table and page
3015 English bezel	Q2669-40002	Table 7-3 on page 291
3015/20/30 print engine <sup>printer</sup> , replacement 110 V	Q2665-67001	Table 7-3 on page 305
3015/20/30 print engine <sup>printer</sup> , replacement 220 V	Q2665-67002	Table 7-3 on page 305
3020 bezel; Arabic	Q2665-40033	Table 7-3 on page 302
3020 bezel; Czech	Q2665-40027	Table 7-3 on page 301
3020 bezel; Danish	Q2665-40022	Table 7-3 on page 301
3020 bezel; Dutch	Q2665-40023	Table 7-3 on page 301
3020 bezel; English	Q2665-40010	Table 7-3 on page 301
3020 bezel; Finnish	Q2665-40024	Table 7-3 on page 301
3020 bezel; French	Q2665-40018	Table 7-3 on page 301
3020 bezel; German	Q2665-40019	Table 7-3 on page 301
3020 bezel; Greek	Q2665-40034	Table 7-3 on page 302
3020 bezel; Hebrew	Q2665-40035	Table 7-3 on page 302
3020 bezel; Hungarian	Q2665-40028	Table 7-3 on page 301
3020 bezel; Italian	Q2665-40020	Table 7-3 on page 301
3020 bezel; Korean	Q2665-40036	Table 7-3 on page 302
3020 bezel; Norwegian	Q2665-40040	Table 7-3 on page 302
3020 bezel; Polish	Q2665-40029	Table 7-3 on page 301
3020 bezel; Portuguese	Q2665-40025	Table 7-3 on page 301
3020 bezel; Russian	Q2665-40030	Table 7-3 on page 301
3020 bezel; Simplified Chinese	Q2665-40037	Table 7-3 on page 302
3020 bezel; Slovak	Q2665-40031	Table 7-3 on page 301
3020 bezel; Spanish	Q2665-40021	Table 7-3 on page 301
3020 bezel; Swedish	Q2665-40026	Table 7-3 on page 301
3020 bezel; Swiss German	Q2665-40042	Table 7-3 on page 302
3020 bezel; Thai	Q2665-40039	Table 7-3 on page 302
3020 bezel; Traditional Chinese	Q2665-40038	Table 7-3 on page 302
3020 bezel; Turkish	Q2665-40032	Table 7-3 on page 301
3020 bezel; Vietnamese	Q2665-40043	Table 7-3 on page 302
3030 bezel; Arabic	Q2666-40018	Table 7-3 on page 302

**Table 7-4. Alphabetical parts list (continued)**

<b>Description</b>	<b>Part number</b>	<b>Table and page</b>
3030 bezel; Czech	Q2666-40012	Table 7-3 on page 302
3030 bezel; Danish	Q2666-40007	Table 7-3 on page 302
3030 bezel; Dutch	Q2666-40008	Table 7-3 on page 302
3030 bezel; English	Q2666-40002	Table 7-3 on page 302
3030 bezel; Finnish	Q2666-40009	Table 7-3 on page 302
3030 bezel; French	Q2666-40003	Table 7-3 on page 302
3030 bezel; German	Q2666-40004	Table 7-3 on page 302
3030 bezel; Greek	Q2666-40019	Table 7-3 on page 302
3030 bezel; Hebrew	Q2666-40020	Table 7-3 on page 302
3030 bezel; Hungarian	Q2666-40013	Table 7-3 on page 302
3030 bezel; Italian	Q2666-40005	Table 7-3 on page 302
3030 bezel; Korean	Q2666-40021	Table 7-3 on page 302
3030 bezel; Norwegian	Q2666-40025	Table 7-3 on page 303
3030 bezel; Polish	Q2666-40014	Table 7-3 on page 302
3030 bezel; Portuguese	Q2666-40010	Table 7-3 on page 302
3030 bezel; Russian	Q2666-40015	Table 7-3 on page 302
3030 bezel; Simplified Chinese	Q2666-40022	Table 7-3 on page 302
3030 bezel; Slovak	Q2666-40016	Table 7-3 on page 302
3030 bezel; Spanish	Q2666-40006	Table 7-3 on page 302
3030 bezel; Swedish	Q2666-40011	Table 7-3 on page 302
3030 bezel; Swiss German	Q2666-40027	Table 7-3 on page 303
3030 bezel; Traditional Chinese	Q2666-40023	Table 7-3 on page 302
3030 bezel; Turkish	Q2666-40017	Table 7-3 on page 302
ADF assembly and flatbed lid	Q2665-60102	Table 7-3 on page 301
ADF cleanout/comb	C7309-40153	Table 7-3 on page 301
ADF glass frame	Q1636-40037	Table 7-3 on page 301
ADF input tray	Q2665-60109	Table 7-3 on page 301
ADF input-tray flag	C7309-40013	Table 7-3 on page 301
ADF input-tray spring	C7309-80013	Table 7-3 on page 301
ADF pickup-roller assembly	C7309-60016	Table 7-3 on page 301
Automatic document feeder and flatbed lid (ADF; part of the flatbed lid)	Q2665-60102-000CN	Table 7-3 on page 297
Bushing	RC1-1953-000CN	Table 7-3 on page 315

**Table 7-4. Alphabetical parts list (continued)**

<b>Description</b>	<b>Part number</b>	<b>Table and page</b>
Compression spring (white platen)	RU5-2196-000CN	Table 7-3 on page 295
Cover, front	RL1-0358-000CN	Table 7-3 on page 309
Cover, left	RC1-2471-000CN	Table 7-3 on page 309
Cover, rear	RC1-2474	Table 7-3 on page 309
Cover, right	RC1-2472-000CN	Table 7-3 on page 309
Cover, top (scanner support frame), printer	RL1-0359-000CN	Table 7-3 on page 309
Delivery tray assembly	RM1-0859-000CN	Table 7-3 on page 305
Delivery-tray assembly (product output bin)	RM1-0859-000CN	Table 7-3 on page 307
Door, print cartridge	RC1-2473-000CN	Table 7-3 on page 309
EMEA LIU (Line interface unit)	Q2687-60002	Table 7-3 on page 305
Engine-controller-PCB assembly	RM1-0907-000CN	Table 7-3 on page 313
Flatbed scanner assembly (does not include the flatbed lid)	Q2665-60112	Table 7-3 on page 301
Flatbed scanner assembly	Q26665-60112-000CN	Table 7-3 on page 297
Fuser (fixing assy) assembly 110-127 V	RM1-0862-000CN	Table 7-3 on page 319
Fuser (fixing assy) assembly 220-240 V	RM1-0863-000CN	Table 7-3 on page 319
HP jewel	7121-8043	Table 7-3 on page 305
HP LaserJet 3015 scanner assembly	NA	Table 7-3 on page 287
HP LaserJet 3020/3030 scanner assembly	NA	Table 7-3 on page 297
Laser/scanner assembly	RM1-0171-000CN	Table 7-3 on page 313
Link, coupling lower	RC1-2485-000CN	Table 7-3 on page 315
Link, coupling top	RC1-2494-000CN	Table 7-3 on page 315
LJ3015 formatter <sup>LIU1</sup>	Q2668-60001	Table 7-3 on page 287
LJ3015 scanner frame assembly	RM1-0883-000CN	Table 7-3 on page 293
LJ3015 scanner pickup assembly	RM1-0885-000CN	Table 7-3 on page 293
LJ3020 copy control panel	Q2665-60101	Table 7-3 on page 297
LJ3020 copy control panel	Q2665-60101	Table 7-3 on page 301
LJ3020 formatter	C2688-60002	Table 7-3 on page 297
LJ3020/3020 ADF glass	C7296-00014	Table 7-3 on page 301
LJ3020/3030 ADF lid	Q26665-60102	Table 7-3 on page 301
LJ3020/3030 ADF solar lock (clip)	Q1636-40036	Table 7-3 on page 301
LJ3020/3030 scanner link assembly left	RM1-0898-000CN	Table 7-3 on page 299



**Table 7-4. Alphabetical parts list (continued)**

<b>Description</b>	<b>Part number</b>	<b>Table and page</b>
LJ3020/3030 scanner link assembly right	RM1-0899-000CN	Table 7-3 on page 299
LJ3020/3030 scanner spring, compression	RU5-2199-000CN	Table 7-3 on page 299
LJ3030 fax control panel	Q2666-60101	Table 7-3 on page 297
LJ3030 fax control panel	Q2666-60101	Table 7-3 on page 302
LJ3030 formatter <sup>LIU2</sup>	Q2664-60001	Table 7-3 on page 297
Motor, stepping	RK2-0107-000CN	Table 7-3 on page 311
Panel, rear	RC1-1985-000CN	Table 7-3 on page 311
Paper-pickup assembly	RM1-0864-000CN	Table 7-3 on page 317
Pickup tray assembly	RM1-0858-000CN	Table 7-3 on page 305
Pickup-tray assembly (media input tray)	RM1-0858-000CN	Table 7-3 on page 307
Power-supply assembly, 110-127 V	RM1-0903-000CN	Table 7-3 on page 311
Power-supply assembly, 220-240 V	RM1-0904-000CN	Table 7-3 on page 311
Print cartridge	Q2460-67913	Table 7-3 on page 305
Roller, pickup	RL1-0266-000CN	Table 7-3 on page 317
Scanner base frame assembly (scanner support frame)	RL1-0375-000CN	Table 7-3 on page 291
Scanner control panel assembly	RK2-0232-000CN	Table 7-3 on page 287
Scanner control-panel assembly	RK2-0232-000CN	Table 7-3 on page 291
Scanner control-panel overlay; Arabic	Q2669-00016	Table 7-3 on page 291
Scanner control-panel overlay; Czech	Q2669-00010	Table 7-3 on page 291
Scanner control-panel overlay; Danish	Q2669-00005	Table 7-3 on page 291
Scanner control-panel overlay; Dutch	Q2669-00006	Table 7-3 on page 291
Scanner control-panel overlay; Finnish	Q2669-00007	Table 7-3 on page 291
Scanner control-panel overlay; French	Q2669-00001	Table 7-3 on page 291
Scanner control-panel overlay; German	Q2669-00002	Table 7-3 on page 291
Scanner control-panel overlay; Hungarian	Q2669-00011	Table 7-3 on page 291
Scanner control-panel overlay; Italian	Q2669-00003	Table 7-3 on page 291
Scanner control-panel overlay; Norwegian	Q2669-00023	Table 7-3 on page 291
Scanner control-panel overlay; Polish	Q2669-00012	Table 7-3 on page 291
Scanner control-panel overlay; Portuguese	Q2669-00008	Table 7-3 on page 291
Scanner control-panel overlay; Russian	Q2669-00013	Table 7-3 on page 291
Scanner control-panel overlay; Slovak	Q2669-00014	Table 7-3 on page 291
Scanner control-panel overlay; Spanish	Q2669-00004	Table 7-3 on page 291

**Table 7-4. Alphabetical parts list (continued)**

<b>Description</b>	<b>Part number</b>	<b>Table and page</b>
Scanner control-panel overlay; Swedish	Q2669-00009	Table 7-3 on page 291
Scanner control-panel overlay; Turkish	Q2669-00015	Table 7-3 on page 291
Scanner cover top assembly	RC1-2564-000CN	Table 7-3 on page 291
Scanner cover, left	RC1-2358-000CN	Table 7-3 on page 291
Scanner cover, right	RC1-2559-000CN	Table 7-3 on page 291
Scanner cushion	RC1-2476-000CN	Table 7-3 on page 309
Scanner flexible flat cable (FFC)	RK2-0236-000CN	Table 7-3 on page 291
Scanner guide assembly	RM1-0889-000CN	Table 7-3 on page 295
Scanner link assembly, left (HP LaserJet 3015)	RM1-0896-000CN	Table 7-3 on page 291
Scanner link assembly, right (HP LaserJet 3015)	RM1-0897-000CN	Table 7-3 on page 291
Scanner media lever (lever, pressure convert)	RC1-2543-000CN	Table 7-3 on page 295
Scanner media lever torsion spring (lever, pressure convert)	RC1-2544-000CN	Table 7-3 on page 295
Scanner pickup tray assembly	RM1-0893-000CN	Table 7-3 on page 289
Scanner separation pad set	RM1-0891-000CN	Table 7-3 on page 295
Scanner separation-pad assembly	RM1-0890-000CN	Table 7-3 on page 295
Scanner sheet, grounding	RL1-0376-000CN	Table 7-3 on page 291
Scanner spring, compression	RU5-2198-000CN	Table 7-3 on page 291
Scanner tray, delivery (wire)	RC1-2560-000CN	Table 7-3 on page 289
Scanner tray, delivery (wire)	RC1-2560-000CN	Table 7-3 on page 287
Scanner white platen	RF5-3235-000CN	Table 7-3 on page 295
Screw, machine M3X6	XB1-2300-605CN	Table 7-3 on page 293
Screw, rs M2X10	XA9-1501-000CN	Table 7-3 on page 313
Screw, rs M3X6	XA9-1495-000CN	Table 7-3 on page 295
Screw, rs M3X6	XA9-1495-000CN	Table 7-3 on page 311
Screw, rs M3X6	XA9-1495-000CN	Table 7-3 on page 313
Screw, rs M3X6	XA9-1495-000CN	Table 7-3 on page 315
Screw, rs M3X8	XA9-1420-000CN	Table 7-3 on page 311
Screw, rs M3X8	XA9-1420-000CN	Table 7-3 on page 313
Screw, rs M3X8	XA9-1420-000CN	Table 7-3 on page 315
Screw, tap BH3X6	XA9-1503-000CN	Table 7-3 on page 291
Screw, tap BH3X8	XA9-1503-000CN	Table 7-3 on page 317
Screw, tap M4X10	XB4-5401-009CN	Table 7-3 on page 291

**Table 7-4. Alphabetical parts list (continued)**

<b>Description</b>	<b>Part number</b>	<b>Table and page</b>
Screw, tap M4X10	XB4-5401-009CN	Table 7-3 on page 293
Screw, tap M4X10	XB4-5401-009CN	Table 7-3 on page 295
Screw, tap M4X10	XB4-5401-009CN	Table 7-3 on page 311
Screw, tap M4X10	XB4-5401-009CN	Table 7-3 on page 317
Screw, w/washer M3X6	XB2-7300-605CN	Table 7-3 on page 293
Screw, w/washer M3X6	XB2-7300-605CN	Table 7-3 on page 295
Screw, w/washer M3X6	XB2-7300-605CN	Table 7-3 on page 311
Screw, w/washer M3X6	XB2-8300-909CN	Table 7-3 on page 319
Separation pad	C7309-60009	Table 7-3 on page 301
Separation-pad assembly, printer	RM1-0648-000CN	Table 7-3 on page 311
Speaker assembly	RM1-0915-000CN	Table 7-3 on page 315
Transfer-roller assembly	RM1-0658-000CN	Table 7-3 on page 311
US/WW LIU (Line interface unit)	Q2663-60001	Table 7-3 on page 305

## Numerical parts list

**Table 7-5. Numerical parts list**

Part number	Description	Table and page
7121-8043	HP jewel	Table 7-3 on page 305
C2688-60002	LJ3020 formatter	Table 7-3 on page 297
C7296-00014	LJ3020/3020 ADF glass	Table 7-3 on page 301
C7309-40013	ADF input-tray flag	Table 7-3 on page 301
C7309-40153	ADF cleanout/comb	Table 7-3 on page 301
C7309-60009	Separation pad	Table 7-3 on page 301
C7309-60016	ADF pickup-roller assembly	Table 7-3 on page 301
C7309-80013	ADF input-tray spring	Table 7-3 on page 301
NA	HP LaserJet 3015 scanner assembly	Table 7-3 on page 287
NA	HP LaserJet 3020/3030 scanner assembly	Table 7-3 on page 297
Q1636-40036	LJ3020/3030 ADF solar lock (clip)	Table 7-3 on page 301
Q1636-40037	ADF glass frame	Table 7-3 on page 301
Q2460-67913	Print cartridge	Table 7-3 on page 305
Q2663-60001	US/WW LIU (Line interface unit)	Table 7-3 on page 305
Q2664-60001	LJ3030 formatter <sup>LIU2</sup>	Table 7-3 on page 297
Q2665-40010	3020 bezel; English	Table 7-3 on page 301
Q2665-40018	3020 bezel; French	Table 7-3 on page 301
Q2665-40019	3020 bezel; German	Table 7-3 on page 301
Q2665-40020	3020 bezel; Italian	Table 7-3 on page 301
Q2665-40021	3020 bezel; Spanish	Table 7-3 on page 301
Q2665-40022	3020 bezel; Danish	Table 7-3 on page 301
Q2665-40023	3020 bezel; Dutch	Table 7-3 on page 301
Q2665-40024	3020 bezel; Finnish	Table 7-3 on page 301
Q2665-40025	3020 bezel; Portuguese	Table 7-3 on page 301
Q2665-40026	3020 bezel; Swedish	Table 7-3 on page 301
Q2665-40027	3020 bezel; Czech	Table 7-3 on page 301
Q2665-40028	3020 bezel; Hungarian	Table 7-3 on page 301
Q2665-40029	3020 bezel; Polish	Table 7-3 on page 301
Q2665-40030	3020 bezel; Russian	Table 7-3 on page 301

**Table 7-5. Numerical parts list (continued)**

<b>Part number</b>	<b>Description</b>	<b>Table and page</b>
Q2665-40031	3020 bezel; Slovak	Table 7-3 on page 301
Q2665-40032	3020 bezel; Turkish	Table 7-3 on page 301
Q2665-40033	3020 bezel; Arabic	Table 7-3 on page 302
Q2665-40034	3020 bezel; Greek	Table 7-3 on page 302
Q2665-40035	3020 bezel; Hebrew	Table 7-3 on page 302
Q2665-40036	3020 bezel; Korean	Table 7-3 on page 302
Q2665-40037	3020 bezel; Simplified Chinese	Table 7-3 on page 302
Q2665-40038	3020 bezel; Traditional Chinese	Table 7-3 on page 302
Q2665-40039	3020 bezel; Thai	Table 7-3 on page 302
Q2665-40040	3020 bezel; Norwegian	Table 7-3 on page 302
Q2665-40042	3020 bezel; Swiss German	Table 7-3 on page 302
Q2665-40043	3020 bezel; Vietnamese	Table 7-3 on page 302
Q2665-60101	LJ3020 copy control panel	Table 7-3 on page 297
Q2665-60101	LJ3020 copy control panel	Table 7-3 on page 301
Q2665-60102	ADF assembly and flatbed lid	Table 7-3 on page 301
Q2665-60102-000CN	Automatic document feeder and flatbed lid (ADF; part of the flatbed lid)	Table 7-3 on page 297
Q2665-60109	ADF input tray	Table 7-3 on page 301
Q2665-60112	Flatbed scanner assembly (does not include the flatbed lid)	Table 7-3 on page 301
Q2665-67001	3015/20/30 print engine <sup>printer</sup> , replacement 110 V	Table 7-3 on page 305
Q2665-67002	3015/20/30 print engine <sup>printer</sup> , replacement 220 V	Table 7-3 on page 305
Q2666-40002	3030 bezel; English	Table 7-3 on page 302
Q2666-40003	3030 bezel; French	Table 7-3 on page 302
Q2666-40004	3030 bezel; German	Table 7-3 on page 302
Q2666-40005	3030 bezel; Italian	Table 7-3 on page 302
Q2666-40006	3030 bezel; Spanish	Table 7-3 on page 302
Q2666-40007	3030 bezel; Danish	Table 7-3 on page 302
Q2666-40008	3030 bezel; Dutch	Table 7-3 on page 302
Q2666-40009	3030 bezel; Finnish	Table 7-3 on page 302
Q2666-40010	3030 bezel; Portuguese	Table 7-3 on page 302
Q2666-40011	3030 bezel; Swedish	Table 7-3 on page 302
Q2666-40012	3030 bezel; Czech	Table 7-3 on page 302

**Table 7-5. Numerical parts list (continued)**

<b>Part number</b>	<b>Description</b>	<b>Table and page</b>
Q2666-40013	3030 bezel; Hungarian	Table 7-3 on page 302
Q2666-40014	3030 bezel; Polish	Table 7-3 on page 302
Q2666-40015	3030 bezel; Russian	Table 7-3 on page 302
Q2666-40016	3030 bezel; Slovak	Table 7-3 on page 302
Q2666-40017	3030 bezel; Turkish	Table 7-3 on page 302
Q2666-40018	3030 bezel; Arabic	Table 7-3 on page 302
Q2666-40019	3030 bezel; Greek	Table 7-3 on page 302
Q2666-40020	3030 bezel; Hebrew	Table 7-3 on page 302
Q2666-40021	3030 bezel; Korean	Table 7-3 on page 302
Q2666-40022	3030 bezel; Simplified Chinese	Table 7-3 on page 302
Q2666-40023	3030 bezel; Traditional Chinese	Table 7-3 on page 302
Q2666-40025	3030 bezel; Norwegian	Table 7-3 on page 303
Q2666-40027	3030 bezel; Swiss German	Table 7-3 on page 303
Q2666-60101	LJ3030 fax control panel	Table 7-3 on page 297
Q2666-60101	LJ3030 fax control panel	Table 7-3 on page 302
Q26665-60102	LJ3020/3030 ADF lid	Table 7-3 on page 301
Q26665-60112-000CN	Flatbed scanner assembly	Table 7-3 on page 297
Q2668-60001	LJ3015 formatter <sup>LIU1</sup>	Table 7-3 on page 287
Q2669-00001	Scanner control-panel overlay; French	Table 7-3 on page 291
Q2669-00002	Scanner control-panel overlay; German	Table 7-3 on page 291
Q2669-00003	Scanner control-panel overlay; Italian	Table 7-3 on page 291
Q2669-00004	Scanner control-panel overlay; Spanish	Table 7-3 on page 291
Q2669-00005	Scanner control-panel overlay; Danish	Table 7-3 on page 291
Q2669-00006	Scanner control-panel overlay; Dutch	Table 7-3 on page 291
Q2669-00007	Scanner control-panel overlay; Finnish	Table 7-3 on page 291
Q2669-00008	Scanner control-panel overlay; Portuguese	Table 7-3 on page 291
Q2669-00009	Scanner control-panel overlay; Swedish	Table 7-3 on page 291
Q2669-00010	Scanner control-panel overlay; Czech	Table 7-3 on page 291
Q2669-00011	Scanner control-panel overlay; Hungarian	Table 7-3 on page 291
Q2669-00012	Scanner control-panel overlay; Polish	Table 7-3 on page 291
Q2669-00013	Scanner control-panel overlay; Russian	Table 7-3 on page 291
Q2669-00014	Scanner control-panel overlay; Slovak	Table 7-3 on page 291

**Table 7-5. Numerical parts list (continued)**

<b>Part number</b>	<b>Description</b>	<b>Table and page</b>
Q2669-00015	Scanner control-panel overlay; Turkish	Table 7-3 on page 291
Q2669-00016	Scanner control-panel overlay; Arabic	Table 7-3 on page 291
Q2669-00023	Scanner control-panel overlay; Norwegian	Table 7-3 on page 291
Q2669-40002	3015 English bezel	Table 7-3 on page 291
Q2687-60002	EMEA LIU (Line interface unit)	Table 7-3 on page 305
RC1-1953-000CN	Bushing	Table 7-3 on page 315
RC1-1985-000CN	Panel, rear	Table 7-3 on page 311
RC1-2358-000CN	Scanner cover, left	Table 7-3 on page 291
RC1-2471-000CN	Cover, left	Table 7-3 on page 309
RC1-2472-000CN	Cover, right	Table 7-3 on page 309
RC1-2473-000CN	Door, print cartridge	Table 7-3 on page 309
RC1-2474	Cover, rear	Table 7-3 on page 309
RC1-2476-000CN	Scanner cushion	Table 7-3 on page 309
RC1-2485-000CN	Link, coupling lower	Table 7-3 on page 315
RC1-2494-000CN	Link, coupling top	Table 7-3 on page 315
RC1-2543-000CN	Scanner media lever (lever, pressure convert)	Table 7-3 on page 295
RC1-2544-000CN	Scanner media lever torsion spring (lever, pressure convert)	Table 7-3 on page 295
RC1-2559-000CN	Scanner cover, right	Table 7-3 on page 291
RC1-2560-000CN	Scanner tray, delivery (wire)	Table 7-3 on page 287
RC1-2560-000CN	Scanner tray, delivery (wire)	Table 7-3 on page 289
RC1-2564-000CN	Scanner cover top assembly	Table 7-3 on page 291
RF5-3235-000CN	Scanner white platen	Table 7-3 on page 295
RK2-0107-000CN	Motor, stepping	Table 7-3 on page 311
RK2-0232-000CN	Scanner control panel assembly	Table 7-3 on page 287
RK2-0232-000CN	Scanner control-panel assembly	Table 7-3 on page 291
RK2-0236-000CN	Scanner flexible flat cable (FFC)	Table 7-3 on page 291
RL1-0266-000CN	Roller, pickup	Table 7-3 on page 317
RL1-0358-000CN	Cover, front	Table 7-3 on page 309
RL1-0359-000CN	Cover, top (scanner support frame), printer	Table 7-3 on page 309
RL1-0375-000CN	Scanner base frame assembly (scanner support frame)	Table 7-3 on page 291
RL1-0376-000CN	Scanner sheet, grounding	Table 7-3 on page 291

**Table 7-5. Numerical parts list (continued)**

<b>Part number</b>	<b>Description</b>	<b>Table and page</b>
RM1-0171-000CN	Laser/scanner assembly	Table 7-3 on page 313
RM1-0648-000CN	Separation-pad assembly, printer	Table 7-3 on page 311
RM1-0658-000CN	Transfer-roller assembly	Table 7-3 on page 311
RM1-0858-000CN	Pickup tray assembly	Table 7-3 on page 305
RM1-0858-000CN	Pickup-tray assembly (media input tray)	Table 7-3 on page 307
RM1-0859-000CN	Delivery tray assembly	Table 7-3 on page 305
RM1-0859-000CN	Delivery-tray assembly (product output bin)	Table 7-3 on page 307
RM1-0862-000CN	Fuser (fixing assy) assembly 110-127 V	Table 7-3 on page 319
RM1-0863-000CN	Fuser (fixing assy) assembly 220-240 V	Table 7-3 on page 319
RM1-0864-000CN	Paper-pickup assembly	Table 7-3 on page 317
RM1-0883-000CN	LJ3015 scanner frame assembly	Table 7-3 on page 293
RM1-0885-000CN	LJ3015 scanner pickup assembly	Table 7-3 on page 293
RM1-0889-000CN	Scanner guide assembly	Table 7-3 on page 295
RM1-0890-000CN	Scanner separation-pad assembly	Table 7-3 on page 295
RM1-0891-000CN	Scanner separation pad set	Table 7-3 on page 295
RM1-0893-000CN	Scanner pickup tray assembly	Table 7-3 on page 289
RM1-0896-000CN	Scanner link assembly, left (HP LaserJet 3015)	Table 7-3 on page 291
RM1-0897-000CN	Scanner link assembly, right (HP LaserJet 3015)	Table 7-3 on page 291
RM1-0898-000CN	LJ3020/3030 scanner link assembly left	Table 7-3 on page 299
RM1-0899-000CN	LJ3020/3030 scanner link assembly right	Table 7-3 on page 299
RM1-0903-000CN	Power-supply assembly, 110-127 V	Table 7-3 on page 311
RM1-0904-000CN	Power-supply assembly, 220-240 V	Table 7-3 on page 311
RM1-0907-000CN	Engine-controller-PCB assembly	Table 7-3 on page 313
RM1-0915-000CN	Speaker assembly	Table 7-3 on page 315
RU5-2196-000CN	Compression spring (white platen)	Table 7-3 on page 295
RU5-2198-000CN	Scanner spring, compression	Table 7-3 on page 291
RU5-2199-000CN	LJ3020/3030 scanner spring, compression	Table 7-3 on page 299
XA9-1420-000CN	Screw, rs M3X8	Table 7-3 on page 311
XA9-1420-000CN	Screw, rs M3X8	Table 7-3 on page 313
XA9-1420-000CN	Screw, rs M3X8	Table 7-3 on page 315
XA9-1495-000CN	Screw, rs M3X6	Table 7-3 on page 295
XA9-1495-000CN	Screw, rs M3X6	Table 7-3 on page 311



**Table 7-5. Numerical parts list (continued)**

<b>Part number</b>	<b>Description</b>	<b>Table and page</b>
XA9-1495-000CN	Screw, rs M3X6	Table 7-3 on page 313
XA9-1495-000CN	Screw, rs M3X6	Table 7-3 on page 315
XA9-1501-000CN	Screw, rs M2X10	Table 7-3 on page 313
XA9-1503-000CN	Screw, tap BH3X6	Table 7-3 on page 291
XA9-1503-000CN	Screw, tap BH3X8	Table 7-3 on page 317
XB1-2300-605CN	Screw, machine M3X6	Table 7-3 on page 293
XB2-7300-605CN	Screw, w/washer M3X6	Table 7-3 on page 293
XB2-7300-605CN	Screw, w/washer M3X6	Table 7-3 on page 295
XB2-7300-605CN	Screw, w/washer M3X6	Table 7-3 on page 311
XB2-8300-909CN	Screw, w/washer M3X6	Table 7-3 on page 319
XB4-5401-009CN	Screw, tap M4X10	Table 7-3 on page 291
XB4-5401-009CN	Screw, tap M4X10	Table 7-3 on page 293
XB4-5401-009CN	Screw, tap M4X10	Table 7-3 on page 295
XB4-5401-009CN	Screw, tap M4X10	Table 7-3 on page 311
XB4-5401-009CN	Screw, tap M4X10	Table 7-3 on page 317



# Index

## Symbols/Numerics

- ###: error message 193
- 50 Fuser Error message 201
- 51 Laser Error message 202
- 52 Scanner Error message 202
- 79 Error message 202

## A

- abbreviations, fax 257
- ac bias 83
- ac power distribution 80
- acoustic emissions 9, 11, 12
- adding paper 43
- ADF
  - copying, troubleshooting 190
  - door open error message 203
  - duty cycle 11
  - features 3
  - feeding problems, troubleshooting 229, 230
  - input tray, removing HP LaserJet 3020/3030 133
  - input tray, replacing 62
  - input-tray flag, removing HP LaserJet 3020/3030 141
  - jam detection, HP LaserJet 3020/3030 95
  - jams, clearing 227
  - loading 45
  - locating 5
  - media specifications 38
  - media supported 43
  - operations, HP LaserJet 3015 87
  - operations, HP LaserJet 3020/3030 94
  - output bin, replacing 63
  - part numbers, HP LaserJet 3015 287
  - part numbers, HP LaserJet 3020/3030 297, 301
  - parts, life expectancies 48
  - pickup roller, removing HP LaserJet 3020/3030 142
  - pickup roller, replacing 61, 63
  - replacing HP LaserJet 3020/3030 104
  - scanner glass, removing HP LaserJet 3020/3030 143
  - separation pad, removing HP LaserJet 3020/3030 140
  - separation pad, replacing HP LaserJet 3015 62
  - separation pad, replacing HP LaserJet 3020/3030 66
  - specifications 9, 11

- adhesive labels
  - loading 43
  - specifications 40
- alert messages 193
- alignment, troubleshooting 213, 217
- answering machines 231, 232
- appropriate responses, fax 256
- Australia 26
- automatic document feeder. *See* ADF

## B

- background, gray 209
- battery specifications 14
- beam detect (BD) signal 83
- bezel, control panel
  - part numbers, HP LaserJet 3015 291
  - part numbers, HP LaserJet 3020 301
  - part numbers, HP LaserJet 3030 302
  - removing HP LaserJet 3015 112
  - removing HP LaserJet 3020/3030 139
  - replacing HP LaserJet 3020/3030 66
- bidirectional communications 75, 77
- billing filters, fax 99
- billing log 241
- bins
  - ADF, replacing 63
  - capacity 8, 10
  - jams, clearing 225
  - locating 5
  - paper feeding operations 85
  - part numbers 305, 307
- black dots, troubleshooting
  - printed pages 208, 214
  - scanned images 220
- black streaks, troubleshooting 219
- block diagrams
  - HP LaserJet 3015 operations 87
  - image formation 83
  - printer functions 78
- block fax list 241
- boot process 75
- breaking paper reams 227
- buffer memory 77
- bushing, part number 315
- buttons, control panel 33

- C**
- cables
  - flexible flat, HP LaserJet 3015 291
  - interface, ordering 284
- calibration, scanner 49
- caller-ID boxes 231, 232
- Canada DOC regulations 25
- Canceled copy. error message 193
- Canceled scan error message 193
- Canceled send error message 194
- card stock specifications 41
- Care Pack, HP 17
- cartridge-door
  - part number 309
  - removing 163
- cartridges
  - checking 206, 238
  - cleaning near 54
  - drum rotation check 237
  - extending life of 76
  - life expectancies 48
  - operations 83, 84
  - part numbers 284, 305
  - recycling 18
  - refilled 18
  - removing 154
  - warranty 16
- central processing unit (CPU), formatter 75
- characters, misprinted 208, 212
- charging roller
  - operations 83
  - power supply 81
- checklists
  - toner cartridge inspection 206
  - troubleshooting 188
- checks
  - control panel 235
  - drum rotation 237
  - half-self-test 235
  - high-voltage contacts 238
- circuitry, power system 80
- CIS (contact image sensor) 91
- CIS Scanner Error message 203
- classes, HP Technical Training 282
- cleaning
  - about, precautions 50
  - exterior 50
  - glass 51
  - high-voltage connection points 238
  - lid backing 52
  - media guides 210
  - print path 50
  - print-cartridge area 54
  - separation pads 56
  - toner off skin or fabric 55
- Cleaning Mode message 194
- cleaning stage, image formation process 84
- clipped pages, troubleshooting 207
- cloth, toner 284
- CO 96, 99
- CODEC circuitry 96
- codes
  - event log 204
  - fax receive 243
  - fax send 248
- Coldfire processor 75
- colored paper, troubleshooting 218
- Comm. error message 194
- commands, PJI 268
- Common settings menu 35
- communication operations 75, 77
- complex pages, printing 77
- component locations
  - HP LaserJet 3015 272, 277
  - HP LaserJet 3020/3030 276, 277
- conditioning stage, image formation process 83
- configuration report, printing 241
- consumables
  - ordering 282
- contact image sensor (CIS) 91
- continuous self-test 262
- contrast, troubleshooting 218
- control panel
  - bezel, removing HP LaserJet 3015 112
  - bezel, removing HP LaserJet 3020/3030 139
  - bezel, replacing 66
  - buttons 33
  - components 31, 76
  - languages, HP LaserJet 3015 291
  - languages, HP LaserJet 3020 301
  - languages, HP LaserJet 3030 302
  - menus 33
  - messages 193
  - part number, HP LaserJet 3015 287
  - removing HP LaserJet 3015 113
  - removing HP LaserJet 3020/3030 139
  - reports, printing 241
  - test 235
  - troubleshooting 189
- controller PCA 78
- copier
  - operations 75
  - specifications 9, 11
- Copy setup menu 34
- copying
  - acoustic emissions 9, 11
  - contrast, troubleshooting 218
  - features 4
  - feeding problems, troubleshooting 229
  - image quality, troubleshooting 216
  - loading originals 44
  - reduction and enlargement capability 9, 11
  - speed 9, 11
  - troubleshooting 190

- country settings 264
- coupling link, part numbers 315
- covers, HP LaserJet 3015 part numbers 291
- covers, part numbers 311
- covers, removing
  - front 165
  - fuser 164
  - print-cartridge 163
  - rear 164
  - scanner side, HP LaserJet 3015 110
  - scanner top, HP LaserJet 3015 126
  - side 161
  - top, HP LaserJet 3015 129
- CPU, formatter 75
- critical error messages 201
- crooked pages, troubleshooting 213, 217
- crooked scans, troubleshooting 230
- curl, troubleshooting 214, 226
- current control, fax line 99
- cushions, scanner
  - installing 167
  - part numbers 309
- custom-sized media, loading 43
- Customer Care Online 282
- cut-off edges 207

## D

- dark copies or scans, troubleshooting 218
- data communication operations 75, 77
- data-store parameters, fax 263
- Date menu 33
- dc bias 83
- DC controller PCA 78
- dc power distribution 80
- Declaration of Conformity 24, 25
- default settings, restoring 265
- delay jams 86
- delivery sensor, paper (PS803) 85
- delivery-delay jams 86
- delivery-stationary jams 86
- demonstration report, printing 241
- density
  - operations 82
  - troubleshooting 208
- developer menu 263
- developing roller 81
- developing stage, image formation process 83
- Device error message 194
- Device is busy error message 194
- dialing, pulse 98
- digital subscriber lines (DSL), troubleshooting 231
- Doc feeder jam error message 194
- Document feeder mispick error message 194
- document sensor (PS1201) 88
- document top sensor (PS 1202) 88
- documentation, ordering 282
- Door open or no print cartridge error message 195

- door, cartridge
  - part number 309
- door, print cartridge
  - removing 163
- door-open paper jams 86
- dots, troubleshooting
  - printed pages 208, 214
  - scanned images 220
- draft mode 76
- DRAM 76
- drivers
  - ordering 282
  - supported 3
- dropouts, troubleshooting 208, 212
- drum
  - inspecting 206
  - operations 83, 84
  - rotation functional check 237
- drum cleaning stage, image formation process 84
- DSL lines, troubleshooting 231
- DSP circuitry 96
- duty cycle
  - ADF 9, 11
  - product 9, 11
  - scanner 9, 11

## E

- ECM (error-correction mode) 242
- EconoMode 76
- ECU
  - assembly, part numbers 313
  - functions 78
  - jam detection operations 85
  - laser/scanner operations 80
  - paper feeding operations 84
  - removing 177
- edges, not printing 207
- electrical specifications 12
- electrophotographic processes
  - operations 83
  - testing 235
- electrostatic discharge (ESD) 103
- EMC statement for Australia 26
- EMI statement for Korea 26
- Engine comm. error message 195
- engine control unit. *See* ECU
- engine power assembly 80
- Enhanced I/O 77
- envelopes
  - loading 43
  - specifications 40
- environmental specifications 8, 30
- error messages
  - alert and warning 193
  - control panel 193
  - critical 201
- error-correction mode (ECM) 242

- ESD (electrostatic discharge) 103
- European Union regulatory information 27
- event log codes 204
- exit rollers, fuser assembly 85
- extended warranty 17
- F**
- factory default settings, restoring 265
- fasteners, types of 284
- fax
  - abbreviations 257
  - additional devices, connecting 231
  - appropriate responses 256
  - billing (metering) tone filters 99
  - data path 97
  - data-store parameters 263
  - downstream current detection 98
  - DSL lines, troubleshooting 231
  - error-correction mode (ECM) 242
  - flash memory storage 99
  - hook state 98
  - hook switch control 98
  - line current control 99
  - margins 10, 13
  - operations 96
  - page storage 99
  - phase sequence 254
  - products supported 3
  - receive codes 243
  - reports, printing 241
  - resolution 10, 13
  - ring detect 98
  - safety isolation 97
  - safety protection circuitry 97
  - send codes 248
  - speed 10, 13
  - T.30 protocol trace report 242, 254
  - troubleshooting 190
- Fax Functions menu 33
- Fax is busy error message 195
- Fax memory full error message 196
- Fax recv. error message 197
- Fax Send error message 197
- Fax setup menu 35
- FCC regulations 20
- features 2
- feed assembly drive rollers 84
- feed system, paper
  - ADF operations, HP LaserJet 3020/3030 94
  - ADF, HP LaserJet 3015 88
  - printer 84
- feeding problems, troubleshooting
  - copier/scanner 229
  - printer 225
- film, transparency
  - cleaning print path with 50
  - loading 39, 43
- Finland laser safety 26
- Fit to Page error message 197
- flash memory, fax 99
- flatbed
  - lid, removing HP LaserJet 3020/3030 134
  - loading originals 46
  - media supported 44
  - part numbers, HP LaserJet 3020/3030 297
- flexible flat cables, part numbers 291
- flowchart, troubleshooting 188
- focusing lenses, operations 83
- form sensor, ADF 95
- formatter
  - fax subsystem 96
  - operations 75
  - part number, HP LaserJet 3015 287
  - part numbers, HP LaserJet 3020/3030 297
  - removing 171
- frame assembly, HP LaserJet 3015 293
- front cover
  - part number 309
  - removing 165
- fuser
  - assembly, part numbers 318
  - cover, removing 164
  - error messages 201
  - exit rollers 85
  - life expectancy 48
  - modes 37
  - operations 84
  - removing 184
- fuses, overcurrent protection (F101, F102) 81
- fusing stage, image formation process 84
- G**
- glass, cleaning 51
- gray background, troubleshooting 209
- grounding sheet 291
- Group dial not allowed in group error message 198
- group-dial report 241
- guide assembly, HP LaserJet 3015 295
- guides
  - cleaning 210
  - troubleshooting 229
- H**
- half-self-test functional check 235
- hardware maintenance agreements 17
- headers, fax 33
- heat output 12
- heavy media 41
- high-voltage contacts check 238
- high-voltage power supply, operations 81
- hook state 98
- hook switch control 98
- HP Care Pack 17
- HP Customer Care Online 282

- HP LaserJet 3015
  - component locations 272, 277
  - components 5
  - operations 87
  - part numbers 287
  - removing and replacing parts 107
- HP LaserJet 3020/3030
  - ADF, replacing 104
  - component locations 276, 277
  - operations 93
  - part numbers 296
  - removing and replacing parts 133
  - scanner assembly, replacing 104
- HP Technical Training 282
- humidity
  - specifications 8
  - troubleshooting 209, 214, 219

**I**

- I/O, Enhanced 77
- IC CS-03 requirements 23
- identification label 7
- image density
  - troubleshooting 208
  - voltage operations 82
- image formation process
  - operations 83
  - testing 235
- image quality, troubleshooting
  - about 206
  - copies and scans 216
  - repetitive defects 222
  - types of problems 206
- input trays. *See* trays
- installing scanner cushions 167
- internal components, part numbers 311
- INTR (Initial Rotation Period) 73
- Invalid date error message 198
- Invalid entry error message 198

**J**

- jams
  - ADF 227, 230
  - clearing 223
  - detection operations, HP LaserJet 3020/3030 95
  - detection operations, printer 85
  - error messages 200
  - multifeeds 227
  - output bin 225
  - preventing 43

**K**

- keys, control panel 33
- Korean EMI statement 26

**L**

- labels
  - loading 43
  - specifications 40
- languages
  - control panel part numbers, HP LaserJet 3015 291
  - control panel part numbers, HP LaserJet 3020 301
  - control panel part numbers, HP LaserJet 3030 302
  - settings 264
- languages, printer 77
- laser safety statement 25
- laser/scanner assembly
  - error messages 202
  - operations 80
  - part numbers 313
  - protective cover 103
  - removing 181
- latent electrostatic image 83
- leading edge
  - detection operations 84, 86
- LEDs, printer control panel
  - off, troubleshooting 188
  - startup messages 75
- LEDs, scanning system 91
- left cover, HP LaserJet 3015 291
- left-side cover
  - part number 309
  - removing 161
- lenses, operations 83
- life expectancies
  - extending print cartridge 76
  - parts 48
- lift plate 84
- light copies or scans, troubleshooting 218
- lights, printer control panel
  - error messages 193
  - off, troubleshooting 188
  - startup messages 75
- lights, scanning system 91
- line current control, fax 99
- line interface unit. *See* LIU
- lines, fax
  - additional devices, connecting 231
  - digital subscriber (DSL) 231
- lines, troubleshooting
  - copies or scans 219
  - printed pages 209
  - white, vertical 215, 218
- link assemblies, part numbers
  - HP LaserJet 3015 291
  - HP LaserJet 3020/3030 299
- link assemblies, removing
  - HP LaserJet 3015 107
  - HP LaserJet 3020/3030 136
- link, coupling 315

## LIU

- data path 97
- hook switch control 98
- operations 75
- part numbers 305
- regional versions 96
- removing 171
- ring detect 98
- safety isolation circuitry 97
- safety protection 97

## loading

- input trays 43
  - originals to copy or scan 44
- long pages, copying or scanning 229
- long-document jams, ADF 95
- loose toner, troubleshooting 211
- LSTR (Last Rotation Period) 73

## M

- machine screws 284
- Macintosh operating systems supported 3
- main input tray
  - capacity 8, 10
  - feeding operations 84
  - feeding problems, troubleshooting 227
  - loading 43
  - media supported 37
  - part number 305, 307
  - removing 158
  - replacing 60
- main motor, removing 182
- main wiring diagrams 269
- maintenance agreements 17
- manuals, ordering 282
- margins
  - faxing 10, 13
  - printer, minimum 207
  - scanner 9, 11
- media
  - ADF feeding operations, HP LaserJet 3015 88
  - ADF feeding operations, HP LaserJet 3020/3030 94
  - curl, troubleshooting 214, 226
  - envelopes 40
  - feed system operations 84
  - fuser modes 37
  - labels 40
  - loading 43
  - size, maximum 9, 10
  - size, minimum 8, 10
  - specifications 37, 39, 41
  - troubleshooting 39
  - weight 9, 11
- media guides
  - cleaning 210
  - troubleshooting 229
- media jams. See jams

## media lever, HP LaserJet 3015

- part numbers 295
- removing 115

## memory

- base 9, 11
- buffer 77
- flash, fax 99
- included 2
- NVRAM init 265
- RAM 76

## Memory Enhancement technology (MEt) 77

## Memory is low error message 198

## menu structure report, printing 241

## menu structure, control panel 33

## menus

- developer 263
- secondary service 262

## messages

- alert and warning 193
- control panel 193
- critical 201
- startup 75

## mirror operations 83

## misalignment, troubleshooting 213, 217

## model number, locating 7

## modems

- connecting to HP LaserJet 3015 all-in-one 233
- connecting to HP LaserJet 3030 all-in-one 233
- features 2, 231
- speed 10, 13

## motors

- HP LaserJet 3015 component locations 274
- operations 79
- removing 182
- stepping, part number 311

## multifeeds

- ADF 230
- printer input trays 227

## N

## No Dial Tone error message 198

## No document sent error message 198

## No fax answer error message 199

## No fax detected error message 200

## No fax pages to reprint error message 200

## noise specifications 12

## NVRAM

- included 76
- init 265

## O

## off-hook 98

## on-hook 98

## on/off switch, locating 5

## one-touch report 241

## Online Customer Care, HP 282

## operating environment, specifications 8, 30



- operating systems supported 3
- operations
  - ADF, HP LaserJet 3015 87
  - ADF, HP LaserJet 3020/3030 94
  - boot process 75
  - components 70
  - ECU 78
  - fax 96
  - formatter 75
  - HP LaserJet 3015 87
  - HP LaserJet 3020/3030 93
  - image formation 83
  - jam detection 85
  - LIU 75
  - motor 79
  - optical system, HP LaserJet 3015 91
  - optical system, HP LaserJet 3020/3030 93
  - paper-feed system, printer 84
  - power system 80
  - print cartridges 84
  - sequences 71
  - troubleshooting image formation 235
- optical system operations
  - HP LaserJet 3015 91
  - HP LaserJet 3020/3030 93
- optimizing feature 38
- order of
  - operations 71
  - removing and replacing parts 104
  - troubleshooting steps 188
- ordering parts and supplies 282
- originals to copy or scan
  - ADF, media supported 43
  - loading 44
- Out of range error message 200
- output bins. *See* bins
- overcurrent/overvoltage protection 81
- overhead transparencies
  - cleaning print path with 50
  - loading 39, 43
- overlay, control panel. *See* bezel, control panel

**P**

- Page Protect 77
- Page too complex error message 200
- pages per minute
  - ADF 3
  - printing 2, 8
- panels, removing. *See* covers, removing
- paper
  - ADF feeding operations, HP LaserJet 3015 88
  - ADF feeding operations, HP LaserJet 3020/3030 94
  - breaking reams 227
  - curl, troubleshooting 214, 226
  - feed system operations 84
  - fuser modes 37
  - loading 43
  - size, maximum 9, 10
  - size, minimum 8, 10
  - specifications 37, 39
  - storing 226
  - troubleshooting 39
  - weight 9, 11
- paper delivery sensor (PS803) 85
- paper feed problems, troubleshooting
  - copier/scanner 229
  - printer 225
- paper guides
  - cleaning 210
  - troubleshooting 229
- paper jams
  - ADF 227, 230
  - clearing 223
  - detection operations 85
  - detection operations, HP LaserJet 3020/3030 95
  - error messages 200
  - multifeeds 227
  - output bin 225
  - preventing 43
- paper lift plate 84
- paper path
  - ADF feeding operations, HP LaserJet 3020/3030 95
  - cleaning 50
- paper top sensor (PS801) 84, 85
- paper-out sensor (PS201) 84, 85
- paper-pickup assembly, part numbers 316
- paper-pickup assembly, removing 186
- paper-present sensor, ADF 95
- parallel cable, ordering 284
- parallel port 10, 11
- parallel ports 192
- parameters, fax data-store 263
- part numbers
  - about 285
  - ADF, HP LaserJet 3015 287
  - ADF, HP LaserJet 3020/3030 297, 301
  - bins 305, 307
  - bushing 315
  - control panel bezels, HP LaserJet 3020 301
  - control panel bezels, HP LaserJet 3030 302
  - control panel overlays, HP LaserJet 3015 291
  - control panel, HP LaserJet 3015 287
  - covers 309, 311
  - covers, HP LaserJet 3015 291
  - cushion, scanner 309
  - engine-controller-PCB assembly 313
  - flatbed, HP LaserJet 3020/3030 297
  - flexible flat cable, HP LaserJet 3015 291
  - formatter, HP LaserJet 3015 287
  - formatter, HP LaserJet 3020/3030 297
  - frame assembly, HP LaserJet 3015 293
  - fuser (fixing assy) assembly 318

- grounding sheet, HP LaserJet 3015 291
- guide assembly, HP LaserJet 3015 295
- HP LaserJet 3015 287
- HP LaserJet 3020/3030 296
- internal components 311
- laser/scanner assembly 313
- link assemblies, HP LaserJet 3015 291
- link assemblies, HP LaserJet 3020/3030 299
- link, coupling 315
- LIU 305
- media levers, HP LaserJet 3015 295
- paper-pickup assembly 316
- pickup roller, HP LaserJet 3015 293
- platen, HP LaserJet 3015 295
- power supplies 311
- print cartridges 305
- printer base 305
- scanner support frame 309
- scanner support frame, HP LaserJet 3015 291
- separation pads, HP LaserJet 3020/3030 295, 301
- separation-pad assembly 311
- speaker assembly 315
- spring, HP LaserJet 3015 291
- spring, HP LaserJet 3020/3030 299
- transfer-roller assembly 311
- trays 305, 307
- partial characters, troubleshooting 208, 212
- parts
  - about removing and replacing 103
  - HP LaserJet 3015 component locations 272, 277
  - HP LaserJet 3020/3030 component locations 276, 277
  - life expectancies 48
  - order of removal 104
  - ordering 282
  - printer, removing 153
  - removing HP LaserJet 3015 107
  - removing HP LaserJet 3020/3030 133
- path
  - ADF feeding operations, HP LaserJet 3020/3030 95
  - feeding operations 84
  - print, cleaning 50
- PCL (Printer Command Language) 77
- phase sequence, fax 254
- Phone Book is empty error message 200
- phone lines
  - additional devices, connecting 231
  - DSL, troubleshooting 231
- phonebook report 241
- phones, connecting extra 231, 232
- photosensitive drum
  - inspecting 206
  - operations 83, 84
  - rotation functional checks 237
- pickup delay jams 86
- pickup roller
  - ADF feeding operations, HP LaserJet 3015 88
  - ADF, removing HP LaserJet 3020/3030 142
  - ADF, replacing 61, 63
  - cleaning 55
  - HP LaserJet 3015 component locations 273
  - life expectancy 48
  - operations 84
  - part numbers, HP LaserJet 3015 293
  - printer, part number 316
  - printer, replacing 57
  - removing HP LaserJet 3015 130
- pickup solenoid (SL001) 84, 86
- pickup stationary jam 86
- PJL (Printer Job Language) 77, 268
- platen
  - cleaning 51
  - removing 131
- ports
  - formatter operations 75
  - included 2, 11
  - locating 5
  - specifications 9
  - troubleshooting 192
- power
  - specifications 12
  - troubleshooting 188
- power cable, ordering 284
- power supplies
  - fax line current control 99
  - operations 80
  - part numbers 311
  - removing 169
  - testing high-voltage 238
  - unplugging 103
- power switch, locating 5
- PowerSave mode 12
- pressure convert levers, HP LaserJet 3015 295
- pressure roller, operations 84
- primary charging roller
  - operations 83
  - power supply 81
- print cartridges
  - checking 206, 238
  - cleaning near 54
  - drum rotation check 237
  - extending life of 76
  - life expectancies 48
  - operations 83, 84
  - part numbers 284, 305
  - recycling 18
  - refilled 18
  - removing 154
  - warranty 16
- print density
  - troubleshooting 208
  - voltage operations 82

print path  
     cleaning 50  
     feeding operations 84  
 PRINT period 73  
 print quality, troubleshooting  
     about 206  
     repetitive defects 222  
     types of problems 206  
 print-cartridge door  
     part number 309  
     removing 163  
 printer base, part numbers 305  
 Printer Command Language (PCL) 77  
 printer drivers  
     ordering 282  
     supported 3  
 Printer jam error message 200  
 Printer Job Language (PJM) 77, 268  
 printer pickup roller  
     cleaning 55  
     life expectancy 48  
     operations 84  
     part number 316  
     replacing 57  
 printer separation pad  
     life expectancy 48  
     operations 84  
     replacing 59  
 printer specifications 8, 10  
 Printer tray is empty error message 200  
 printing  
     feed problems 225  
     loading media 43  
     speed 8, 10  
     troubleshooting 191, 207  
 priority input tray  
     capacity 8, 10  
     feeding operations 84  
     feeding problems, troubleshooting 227  
     loading 43  
 processor, formatter 75  
 protocol trace report, fax 242, 254  
 PSTN 96  
 pulse dialing 98

**Q**

quality, troubleshooting  
     about 206  
     copies and scans 216  
     repetitive defects 222  
     types of problems 206

**R**

RAM 76  
 reams, breaking 227

rear cover  
     part number 309, 311  
     removing 164  
 receive codes, fax 243  
 recycling print cartridges 18  
 redistributing toner 206  
 reduction settings 207, 221  
 refilled print cartridges 18  
 region settings 264  
 regulatory statements. See statements  
 removing  
     ADF input tray, HP LaserJet 3020/3030 133  
     ADF input-tray flag, HP LaserJet 3020/3030 141  
     ADF pickup roller, HP LaserJet 3020/3030 142  
     ADF scanner glass, HP LaserJet 3020/3030 143  
     ADF separation pad, HP LaserJet 3020/3030 140  
     control panel bezel, HP LaserJet 3015 112  
     control panel bezel, HP LaserJet 3020/3030 139  
     control panel, HP LaserJet 3015 113  
     control panel, HP LaserJet 3020/3030 139  
     ECU 177  
     flatbed lid, HP LaserJet 3020/3030 134  
     formatter 171  
     front cover 165  
     fuser 184  
     fuser cover 164  
     HP LaserJet 3015 parts 107  
     HP LaserJet 3020/3030 parts 133  
     laser/scanner assembly 181  
     link assemblies, HP LaserJet 3015 107  
     link assemblies, HP LaserJet 3020/3030 136  
     LIU 171  
     main motor 182  
     media input tray 158  
     media lever and torsion spring, HP LaserJet 3015 115  
     order of 104  
     paper-pickup assembly 186  
     parts 103  
     pickup roller, HP LaserJet 3015 130  
     power supply 169  
     print cartridge 154  
     print-cartridge door 163  
     printer parts 153  
     rear cover 164  
     scanner assembly, HP LaserJet 3015 118  
     scanner assembly, HP LaserJet 3020/3030 145  
     scanner side covers, HP LaserJet 3015 110  
     scanner support frame 175  
     scanner support frame springs, HP LaserJet 3015 107  
     scanner support frame springs, HP LaserJet 3020/3030 136  
     scanner top cover, HP LaserJet 3015 126  
     separation pad assembly, HP LaserJet 3015 116  
     separation-pad set, HP LaserJet 3015 111  
     side covers 161

- speaker assembly 168
- top cover, HP LaserJet 3015 129
- transfer roller 159
- white platen 131
- repetitive defects, troubleshooting 212, 222
- replacement intervals 48
- replacing
  - ADF input tray 62
  - ADF input-tray flag, HP LaserJet 3020/3030 141
  - ADF output bin 63
  - ADF pickup roller 61, 63
  - ADF pickup roller, HP LaserJet 3020/3030 142
  - ADF scanner glass, HP LaserJet 3020/3030 143
  - ADF separation pad, HP LaserJet 3020/3030 140
  - ADF separation pads 62
  - ADF separation pads HP LaserJet 3020/3030 66
  - ADF, HP LaserJet 3020/3030 104
  - control panel bezel, HP LaserJet 3015 112
  - control panel, HP LaserJet 3015 113
  - control panel, HP LaserJet 3020/3030 139
  - control-panel bezel 66
  - ECU 177
  - flatbed lid, HP LaserJet 3020/3030 134
  - formatter 171
  - front cover 165
  - fuser 184
  - fuser cover 164
  - HP LaserJet 3015 parts 107
  - HP LaserJet 3020/3030 parts 133
  - laser/scanner assembly 181
  - link assemblies, HP LaserJet 3015 107
  - link assemblies, HP LaserJet 3020/3030 136
  - LIU 171
  - main input tray 60
  - main motor 182
  - media input tray 158
  - media lever and torsion spring, HP LaserJet 3015 115
  - order of 104
  - paper-pickup assembly 186
  - parts 103
  - pickup roller, HP LaserJet 3015 130
  - power supply 169
  - print cartridge 154
  - print-cartridge door 163
  - printer parts 153
  - printer pickup roller 57
  - printer separation pads 59
  - rear cover 164
  - scanner assembly, HP LaserJet 3015 118
  - scanner assembly, HP LaserJet 3020/3030 104, 145
  - scanner cushions 167
  - scanner side covers, HP LaserJet 3015 110
  - scanner support frame 175
  - scanner support frame springs, HP LaserJet 3015 107
  - scanner support frame springs, HP LaserJet 3020/3030 136
  - scanner top cover, HP LaserJet 3015 126
  - separation pad assembly, HP LaserJet 3015 116
  - separation-pad set, HP LaserJet 3015 111
  - side covers 161
  - speaker assembly 168
  - top cover, HP LaserJet 3015 129
  - transfer roller 159
  - white platen 131
- reports
  - continuous self-test 262
  - control panel menu structure 33
  - fax 241
  - fax data-store parameters 263
  - fax receive codes 243
  - fax send codes 248
  - menu 34
  - printing 241
  - secondary service 262
  - T.30 protocol trace 242, 254
- reset, soft 265
- residual paper jams 86
- resizing scanned images 221
- resolution
  - faxing 10, 13
  - printing 9, 11
  - scanning 9, 11
- restoring default settings 265
- right cover, HP LaserJet 3015 291
- right-side cover
  - part number 309
  - removing 161
- RING 96, 97, 99
- ring detect 98
- rollers
  - ADF feeding operations, HP LaserJet 3015 88
  - ADF pickup, removing HP LaserJet 3020/3030 142
  - ADF pickup, replacing 61, 63
  - cleaning around 50
  - cleaning pickup 55
  - HP LaserJet 3015 component locations 273
  - life expectancies 48
  - paper feeding operations 84
  - part numbers, HP LaserJet 3015 293
  - pickup, removing HP LaserJet 3015 130
  - printer pickup, part number 316
  - printer pickup, replacing 57
  - printer printer pickup, replacing 156
  - transfer, part number 311
  - transfer, removing 159
- rotation, drum 237
- ruler, repetitive defect 222

- S**
- scanner
    - assembly, replacing HP LaserJet 3020/3030 104
    - Bulb Failure error message 204
    - calibration 49
    - CIS error message 203
    - cleaning 51
    - cushions, installing 167
    - cushions, part numbers 309
    - features 3
    - feeding problems, troubleshooting 229
    - flatbed lid, removing HP LaserJet 3020/3030 134
    - HP LaserJet 3015 operations 87
    - HP LaserJet 3015 part numbers 287
    - operations 75
    - operations, HP LaserJet 3015 91
    - operations, HP LaserJet 3020/3030 93
    - part numbers, HP LaserJet 3020/3030 296
    - removing HP LaserJet 3015 118
    - removing, HP LaserJet 3020/3030 145
    - side covers, removing HP LaserJet 3015 110
    - specifications 9, 11
    - support frame part number, HP LaserJet 3015 291
    - support frame springs, removing HP LaserJet 3015 107
    - support frame springs, removing HP LaserJet 3020/3030 136
    - support frame, part number 309
    - support frame, removing 175
    - top cover, removing 126
  - scanner capacities and ratings 9, 11
  - Scanner reserved for PC scan error message 200
  - scanning
    - contrast, troubleshooting 218
    - image quality, troubleshooting 216
    - loading originals 44
    - margins 9, 11
    - resolution 9, 11
    - text, troubleshooting 220
    - troubleshooting 192
  - Scanning error message 201
  - scanning exposure stage, image formation process 83
  - scatter, toner 214
  - schedules, HP Technical Training 282
  - screwdrivers, required 103
  - screws
    - self-tapping 103
    - types of 284
  - secondary service menu 262
  - self test, continuous 262
  - self-tapping screws 103, 284
  - send codes, fax 248
  - sensors
    - ADF feeding operations, HP LaserJet 3015 88
    - ADF, HP LaserJet 3020/3030 95
    - HP LaserJet 3015 component locations 274
    - optical system, HP LaserJet 3015 91
    - printer paper-feed system 84
  - separation pads
    - ADF feeding operations, HP LaserJet 3015 88
    - ADF, removing HP LaserJet 3020/3030 140
    - ADF, replacing HP LaserJet 3015 62
    - ADF, replacing HP LaserJet 3020/3030 66
    - assembly, removing HP LaserJet 3015 116
    - cleaning 56
    - HP LaserJet 3015 component locations 273
    - life expectancies 48
    - operations 84
    - part numbers, HP LaserJet 3015 295
    - part numbers, HP LaserJet 3020/3030 301
    - printer, part numbers 311
    - printer, replacing 59, 154
    - removing HP LaserJet 3015 111
  - separation stage, image formation process 83
  - sequence
    - operations 71
    - troubleshooting steps 188
  - serial number, locating 7
  - Service menu
    - secondary 262
    - settings 36
  - servicing product 103
  - settings
    - country/region 264
    - fax data-store parameters 263
    - NVRAM init 265
  - Settings cleared error message 201
  - sheet, grounding 291
  - SHUNT function 99
  - side covers
    - part numbers 309
    - removing printer 161
    - removing scanner, HP LaserJet 3015 110
  - signals, VIDEO 73
  - size
    - margins, minimum 207
    - product specifications 8
    - scanned images 221
    - space requirements 30
  - skew
    - copies or scans, troubleshooting 230
    - printed pages, troubleshooting 213, 217
    - specifications 12
  - smears, toner 210
  - soft reset 265
  - software
    - installation, troubleshooting 191
    - ordering 282
    - supported 3

- solenoid (SL001) 84, 86
- space requirements 30
- speaker assembly
  - part number 315
  - removing 168
- specifications
  - ADF 9, 11
  - battery 14
  - card stock and heavy media 41
  - copier 9, 11
  - envelopes 40
  - features 2
  - labels 40
  - media 37
  - physical 8
  - printer 8, 10
  - scanner 9, 11
  - skew 12
  - space requirements 30
- specks, toner 208, 214
- speed
  - ADF 3
  - copy 9, 11
  - data transfer 77
  - fax 10, 13
  - modem 10, 13
  - print 8, 10
  - printing 2
  - processor 75
- speed dial report 241
- spots
  - printed pages 208, 214
  - scanned images 220
- spring, compression
  - HP LaserJet 3015 291
  - HP LaserJet 3020/3030 299
- stages
  - image formation 83, 235
  - operation sequence 71
- stall jams, ADF 95
- standby power specifications 12
- star screws 284
- startup messages 75
- statements
  - Australian EMC 26
  - Declaration of Conformity 24, 25
  - FCC Part 68 requirements 20
  - Finland laser 26
  - IC CS-03 requirements 23
  - Korean EMI 26
  - laser safety 25
  - telephone consumer protection act 22
- static eliminator, operations 83
- static, precautions 103
- stationary jams 86
- STBY (Standby) period 73
- stepping motor, part number 311
- storage environment, specifications 8
- stored fax pages 99
- storing paper 226
- streaks, vertical black 219
- stripes, vertical white 215, 218
- supplies
  - life expectancies 48
  - ordering 282
- support frame, scanner
  - part number, HP LaserJet 3015 291
  - removing 175
  - springs 107
- support, technical 282

**T**

- T.30 protocol trace report, fax 242, 254
- technical support 282
- Technical Training 282
- telephone consumer protection act 22
- telephone lines
  - additional devices, connecting 231
  - DSL, troubleshooting 231
- telephones, connecting extra 231, 232
- temperature
  - specifications 8
  - storing paper 226
  - troubleshooting 214
- tests
  - control panel 235
  - drum rotation 237
  - half-self functional check 235
  - high-voltage contacts 238
- text, troubleshooting
  - misprinted 208, 212
  - scanned 220
- Time/Date Header menu 33
- timing diagrams 74
- TIP 96, 97, 99
- toner
  - cleaning from skin or fabric 55
  - cloth, ordering 284
  - image formation operations 83
  - loose, troubleshooting 211
  - redistributing 206
  - scattered, troubleshooting 214
  - smears, troubleshooting 210
  - specks, troubleshooting 208
  - waste cleaning operations 84
- toner cartridges. See print cartridges
- tools, required 103
- top cover
  - part number, HP LaserJet 3015 291
  - printer, part number 309
  - removing 126, 129
- torsion spring, removing HP LaserJet 3015 115
- torx screws 284
- trace report, fax 242, 254

- trailing edge detection, ADF 95
- trailing edge, detection 86
- Training, HP Technical 282
- transfer roller
  - assembly, part number 311
  - cleaning around 50
  - operations 83
  - power supply 81
  - removing 159
- transfer stage, image formation process 83
- transparencies
  - cleaning print path with 50
  - loading 43
  - specifications 39
- trays
  - ADF input, removing HP LaserJet 3020/3030 133
  - ADF input, replacing 62
  - empty, error messages 200
  - feeding problems 227
  - included 2
  - loading 43
  - locating 5
  - media supported 37
  - paper feed system 84
  - part numbers 305, 307
  - removing 158
  - replacing main input 60
- troubleshooting
  - ADF copying 190
  - ADF feeding problems 229
  - ADF jams 227
  - basic steps 188
  - characters, partially printed 208, 212
  - contrast, copies or scans 218
  - control panel 189, 235
  - copier feeding problems 229
  - copy quality 216
  - copying 190
  - country/region settings 264
  - critical error messages 201
  - curled pages 214, 226
  - dots or streaks in scans 220
  - drum rotation 237
  - DSL lines 231
  - error messages, control panel 193
  - event log codes 204
  - fax error-correction mode (ECM) 242
  - fax receive codes 243
  - fax reports 241
  - fax send codes 248
  - fax T.30 protocol trace report 242, 254
  - faxing 190
  - feeding problems 225
  - gray background 209
  - half self-test functional check 235
  - high-voltage contacts 238
  - image formation 235
  - image quality 206
  - jams 223
  - lights, printer control panel 188
  - loose toner 211
  - media problems 39
  - multifeeds 227
  - NVRAM init 265
  - power 188
  - printing 191, 207
  - repetitive defects 212, 222
  - scanned text 220
  - scanner feeding problems 229
  - scanning 192
  - scanning quality 216
  - secondary service menu 262
  - skewed printed pages 213
  - soft reset 265
  - software installation 191
  - toner scatter 214
  - toner smears 210
  - toner specks 208
  - tools 241
  - vertical black streaks 219
  - vertical lines 209
  - white vertical stripes 215, 218
- truss head screws 284
- two-way communications 75, 77

**U**

- unplugging power cord 103

**USB**

- cable, ordering 284
- port 11
- specifications 10

**V**

- V.34
  - enabling or disabling 242
- V.34 fax standard 242
- vertical black streaks, troubleshooting 219
- vertical defects, troubleshooting 212
- vertical lines, troubleshooting 209
- vertical white stripes, troubleshooting 215, 218
- VIDEO signals 73
- voltage
  - DC power supply 80
  - fax line current control 99
  - high-voltage power supply 82
  - overvoltage protection 81

**W**

- WAIT period 71, 73
- warning messages 193

- warranty
  - extended 17
  - print cartridges 16
  - product 15
  - refilled cartridges, impact on 18
- waste toner receptacle 84
- wave, troubleshooting 214, 226
- websites 282
- weight
  - ADF media 9, 11
  - battery 14
  - media 9, 11
  - product 8

- white platen
  - cleaning 51
  - part number, HP LaserJet 3015 295
  - part numbers, HP LaserJet 3015 295
  - removing 131
- white stripes, troubleshooting 215, 218
- Windows operating systems supported 3
- wiring diagrams 269
- wrapping jams 86
- wrinkled pages, troubleshooting 226
- writing stage, image formation process 83







i n v e n t

© 2004 Hewlett-Packard Development Company, LP

[www.hp.com/support/lj3015](http://www.hp.com/support/lj3015)  
[www.hp.com/support/lj3020](http://www.hp.com/support/lj3020)  
[www.hp.com/support/lj3030](http://www.hp.com/support/lj3030)



Q2665-90901