



HP Z220 SFF, Z220 CMT, Z420, Z620, and Z820 Workstations

Maintenance and Service Guide

Copyright Information

© Copyright 2012-2014 Hewlett-Packard Development Company, L.P.

Fifth Edition: March 2014

First Edition: April 2012

Part Number: 669531-005

Warranty

Hewlett-Packard Company shall not be liable for technical or editorial errors or omissions contained herein or for incidental or consequential damages in connection with the furnishing, performance, or use of this material. The information in this document is provided "as is" without warranty of any kind, including, but not limited to, the implied warranties of merchantability and fitness for a particular purpose, and is subject to change without notice. The warranties for HP products are set forth in the express limited warranty statements accompanying such products.

Nothing herein should be construed as constituting an additional warranty.

The information contained herein is subject to change without notice. The only warranties for HP products and services are set forth in the express warranty statements accompanying such products and services. Nothing herein should be construed as constituting an additional warranty. HP shall not be liable for technical or editorial errors or omissions contained herein.

Not all features are available in all editions of Windows 8. This computer may require upgraded and/or separately purchased hardware, drivers and/or software to take full advantage of Windows 8 functionality. See <http://www.microsoft.com> for details.

This computer may require upgraded and/or separately purchased hardware and/or a DVD drive to install the Windows 7 software and take full advantage of Windows 7 functionality. See <http://windows.microsoft.com/en-us/windows7/get-know-windows-7> for details.

Trademark Credits

Windows is a U.S. registered trademark of the Microsoft group of companies.

Intel, Core, Pentium, and Xeon are trademarks are trademarks of Intel Corporation in the U.S. and other countries.

FireWire is a trademark of Apple Computer, Inc., registered in the U.S. and other countries.

About this guide

This guide provides service and maintenance information, technical details and configuration guidance for the HP Z220 SFF, Z220 CMT, Z420, Z620, and Z820 Workstations.



IMPORTANT: Removal and replacement procedures are now available in videos on the HP website.

Go to the HP Customer Self-Repair Services Media Library at <http://www.hp.com/go/sml>.

Guide topics

[Hardware overview on page 1](#)

[System management on page 38](#)

[Component replacement information and guidelines on page 74](#)

[Diagnostics and troubleshooting on page 112](#)

[Configuring password security and resetting CMOS on page 153](#)

[Linux technical notes on page 157](#)

[Configuring RAID devices on page 161](#)

[System board designators on page 173](#)



NOTE: View the *HP Z220 SFF, Z220 CMT, Z420, Z620, and Z820 Workstation Series User Guide* at http://www.hp.com/support/workstation_manuals.

Table of contents

1 Hardware overview	1
HP Z220 SFF Workstation components	1
HP Z220 SFF Workstation front panel components	2
HP Z220 SFF Workstation rear panel components	3
HP Z220 SFF Workstation chassis components	4
HP Z220 SFF Workstation system board component	5
HP Z220 SFF Workstation system board architecture	6
Workstation specifications	7
HP Z220 CMT Workstation components	8
HP Z220 CMT Workstation front panel components	9
HP Z220 CMT Workstation rear panel components	10
HP Z220 CMT Workstation chassis components	11
HP Z220 CMT Workstation system board component	12
HP Z220 CMT Workstation system board architecture	13
Workstation specifications	14
HP Z420 Workstation components	15
HP Z420 Workstation front panel	16
HP Z420 Workstation rear panel	17
HP Z420 Workstation chassis components	18
HP Z420 Workstation system board components	19
HP Z420 Workstation system board architecture	20
HP Z420 Workstation specifications	21
HP Z620 Workstation components	23
HP Z620 Workstation front panel	23
HP Z620 Workstation rear panel	24
HP Z620 Workstation chassis components	25
HP Z620 Workstation system board components	26
HP Z620 Workstation system board architecture	27
HP Z620 Workstation specifications	28
HP Z820 Workstation components	30
HP Z820 Workstation front panel	30
HP Z820 Workstation rear panel	31
HP Z820 Workstation chassis components	32
HP Z820 Workstation system board components	33
HP Z820 Workstation system board architecture	34
HP Z820 Workstation specifications	35

Environmental specifications	36
Ensuring proper ventilation	37

2 System management 38

Power management and performance features	38
ERP compliance mode	38
Hyper-Threading Technology (HTT)	39
SATA Power Management	39
Intel Turbo Boost Technology	39
HP Cool Tools (Windows 7 only)	39
Non-Uniform Memory Access (NUMA)	40
BIOS ROM	40
Computer Setup (F10) Utility	41
Computer Setup (F10) functionality	41
Accessing Computer Setup (F10) Utility	42
Computer Setup (F10) Utility menu	43
Desktop management	57
Initial computer configuration and deployment	58
Installing a remote system	58
Copying a setup configuration to another computer	59
Updating and managing software	60
HP Client Management Solutions	60
Altiris Client Management Solutions	60
HP SoftPaq Download Manager	60
System Software Manager	61
ROM Flash	61
Remote ROM Flash	61
HPQFlash	61
FailSafe Boot Block	61
Recovering the computer from Boot Block Recovery mode	62
Workstation security	62
Asset tracking	63
SATA hard disk drive security	64
DriveLock applications	65
Using DriveLock	65
Password security	67
Establishing a setup password using Computer Setup (F10) Utility	67
Establishing a power-on password using computer setup	68
Entering a power-on password	68
Entering a setup password	69

Changing a power-on or setup password	69
Deleting a power-on or setup password	70
National keyboard delimiter characters	70
Clearing passwords	71
Chassis security	71
Smart Cover Sensor (optional)	71
Side access panel solenoid lock	72
Cable lock (optional)	72
Fault notification and recovery	72
Drive Protection System	72
ECC fault prediction	72
Thermal sensors	72
Programmable power button (Windows only)	73
Changing the power button configuration (Windows only)	73
3 Component replacement information and guidelines	74
Warnings and cautions	74
Service considerations	75
Tools and software requirements	75
Electrostatic discharge (ESD) information	75
Product recycling	77
Component replacement guidelines	77
Battery	77
Cable management	78
CPU (processor) and CPU heatsink	79
Expansion slots	80
Card configuration restrictions for power supplies	80
Choosing an expansion card slot	80
HP Z220 SFF Workstation slot identification and description	81
HP Z220 SFF Workstation installation sequence recommendations	82
HP Z220 CMT Workstation slot identification and description	83
HP Z220 CMT Workstation installation sequence recommendations	84
HP Z420 Workstation slot identification and description	85
HP Z420 Workstation installation sequence recommendations	86
HP Z620 Workstation slot identification and description	87
HP Z620 Workstation installation sequence recommendations	88
HP Z820 Workstation slot identification and description	89
HP Z820 Workstation installation sequence recommendations	90
Hard disk drives and optical disc drives	91
Handling hard disk drives	91
Removal and replacement tips	91

Drive installation and cabling scenarios	92
HP Z220 SFF Workstations — SATA cable connection guidelines	92
HP Z220 CMT Workstations — SATA cable connection guidelines	92
HP Z420 Workstations — Intel AHCI SATA controller guidelines	93
HP Z420 Workstations — LSI 9212-4i RAID controller guidelines ...	94
HP Z620 Workstations — Intel AHCI SATA controller guidelines	95
HP Z620 Workstations — LSI 9212-4i RAID controller guidelines ...	96
HP Z820 Workstation cabling guidelines	97
Memory	98
Supported DIMM configurations	98
BIOS errors and warnings	99
DIMM installation guidelines	99
HP Z220 SFF Workstation DIMM installation order	100
HP Z220 CMT Workstation DIMM installation order	100
HP Z420 Workstation DIMM installation order	101
HP Z620 Workstation DIMM installation order	102
HP Z820 Workstation DIMM installation order	103
Power supply	104
Power supply specifications	104
Power consumption and heat dissipation	106
Resetting the power supply	106
System board	106
System cabling	107
HP Z220 SFF Workstation system cabling	107
HP Z220 CMT Workstation system cabling	108
HP Z420 Workstation system cabling	109
HP Z620 Workstation system cabling	110
HP Z820 Workstation system cabling	111
4 Diagnostics and troubleshooting	112
Calling support	113
Locating ID labels	114
Locating warranty information	115
Diagnosis guidelines	115
Diagnosis at startup	115
Diagnosis during operation	116
Troubleshooting checklist	117
HP troubleshooting resources and tools	118
HP Support Assistant	118

Online support	118
Troubleshooting a problem	119
Instant Support and Active Chat	119
Customer Advisories, Customer and Security Bulletins, and Customer Notices	119
Product Change Notifications	119
Helpful hints	120
At startup	120
During operation	120
Customer Self-Repair program	121
Troubleshooting scenarios and solutions	122
Solving minor problems	122
Solving hard drive problems	124
Solving display problems	125
Solving audio problems	127
Solving printer problems	128
Solving power supply problems	129
Testing power supply	129
Self-troubleshooting with HP Vision Diagnostics	131
Overview	131
Downloading and accessing HP Vision Diagnostics	132
Accessing HP Vision Diagnostics on the computer	132
Creating and using a bootable USB key	133
Creating and using a bootable DVD	133
Using the HP Memory Test utility	133
User interface	134
Survey tab	135
Test tab	136
Status tab	137
History tab	137
Errors tab	138
Help tab	138
Saving and printing information in HP Vision Diagnostics	139
Self-troubleshooting with HP PC Hardware Diagnostics	140
Downloading HP PC Hardware Diagnostics	141
Accessing HP PC Hardware Diagnostics	142
User interface	142
Running HP PC Hardware Diagnostics	143
System information	143
Hardware diagnostic tests	144
Diagnostic codes and errors	145

Diagnostic LED and audible (beep) codes	145
LED color definitions	148
POST error messages	148
5 Configuring password security and resetting CMOS	153
Preparing to configure passwords	153
Resetting the password jumper	154
Clearing and resetting the CMOS	155
Using the CMOS button to reset CMOS	155
Using Computer Setup (F10) Utility to reset CMOS	156
Appendix A Linux technical notes	157
System RAM	157
Audio	157
Network cards	158
Hyper-Threading Technology	158
NVIDIA Graphics Workstations	159
AMD Graphics Workstations	160
Appendix B Configuring RAID devices	161
RAID hard drive maximum and associated storage controller options	161
Supported RAID configurations	162
Configuring Intel SATA RAID	163
Configuring system BIOS	164
Configuring RAID with the Intel utility	165
Configuring RAID on an LSI 2308 or LSI 9212-4i controller	166
RAID 0 configuration	166
RAID 1 configuration	167
RAID 1E/10 configuration	168
Configuring RAID on an LSI 9260-8i MegaRAID controller	169
RAID 0	169
Software RAID solution	171
Software RAID considerations	171
Performance considerations	171
Configuring software RAID	172
Appendix C System board designators	173
HP Z220 SFF Workstation	173
HP Z220 CMT Workstation	174
HP Z420 and Z620 Workstation system board designators	175

HP Z820 Workstations 177

Index **180**

1 Hardware overview

This chapter presents an overview of workstation hardware components.

- [HP Z220 SFF Workstation components](#)
- [HP Z220 CMT Workstation components](#)
- [HP Z420 Workstation components](#)
- [HP Z620 Workstation components](#)
- [HP Z820 Workstation components](#)
- [Environmental specifications](#)
- [Ensuring proper ventilation](#)





HP Z220 SFF Workstation components

For complete and current information on supported accessories and components for the workstation, see <http://partsurfer.hp.com>.

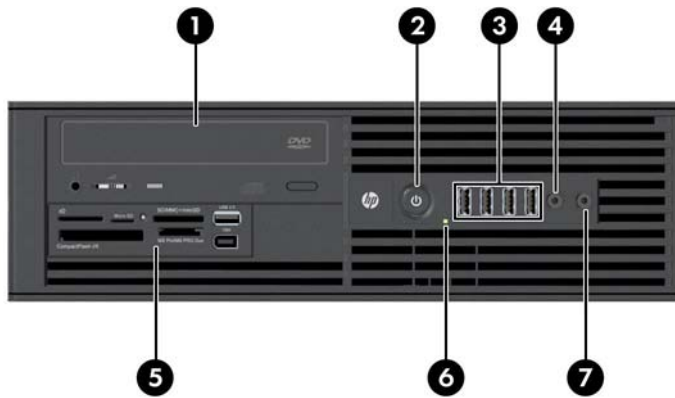
- [HP Z220 SFF Workstation front panel components](#)
- [HP Z220 SFF Workstation rear panel components](#)
- [HP Z220 SFF Workstation chassis components](#)
- [HP Z220 SFF Workstation system board component](#)
- [HP Z220 SFF Workstation system board architecture](#)
- [Workstation specifications](#)

HP Z220 SFF Workstation front panel components







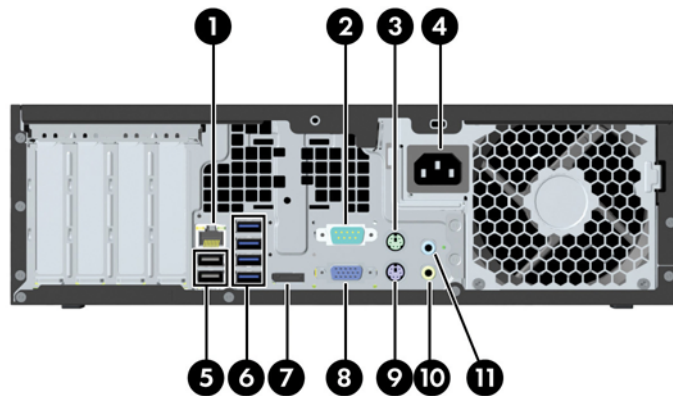





1	Optical drive	5	Optional media card reader (shown) or optional second hard disk drive
2	 Power button	6	 Hard drive or optical drive activity light
3	 USB 2.0 ports (4, black)	7	 Headphones connector
4	 Microphone or headphones connector (software selectable, default mode is microphone)		

HP Z220 SFF Workstation rear panel components



 **NOTE:** The labels for the rear panel connectors use industry-standard icons and colors.

1		RJ-45 network connector	7		DisplayPort (DP)
2		Serial port	8		VGA (monitor) (blue)
3		PS/2 mouse connector (green)	9		PS/2 keyboard connector (purple)
4		Power cord connector	10		Audio line-out connector (green)
5		USB 2.0 ports (2) (back)	11		Audio line-in connector (blue)
6		USB 3.0 ports (4) (blue)			

 **NOTE:** The DP and VGA ports are not supported when the system is configured with Intel® Xeon® E3-12x0 v2 processors. Also, if a discrete graphics card is installed, these ports are disabled by default.

 **NOTE:** Simultaneous usage of integrated Intel HD graphics and discrete graphics cards (in order to drive more than two displays) can be enabled using the Computer (F10) Setup Utility. However, HP recommends using only discrete graphics cards when attaching three or more displays.

HP Z220 SFF Workstation chassis components

For complete and current information on supported accessories and components for the computer, see <http://partsurfer.hp.com>.

The following image shows the components of a typical computer layout. Drive configurations can vary.

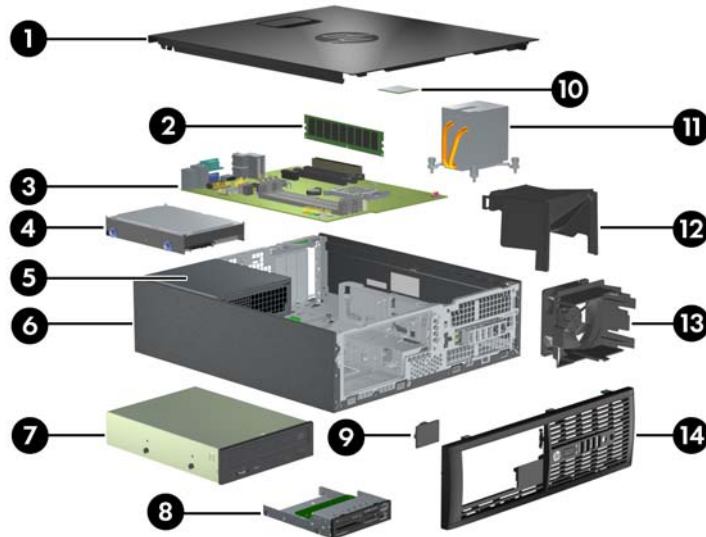

1	Access panel	8	Optional media reader or second hard disk drive
2	Memory module (DIMM)	9	Speaker
3	System board	10	CPU
4	Hard disk drive	11	Heatsink
5	Power supply	12	Airflow guide
6	Chassis	13	System fan
7	Optical drive	14	Front bezel

HP Z220 SFF Workstation system board component

The following illustration and table identify computer system board components.

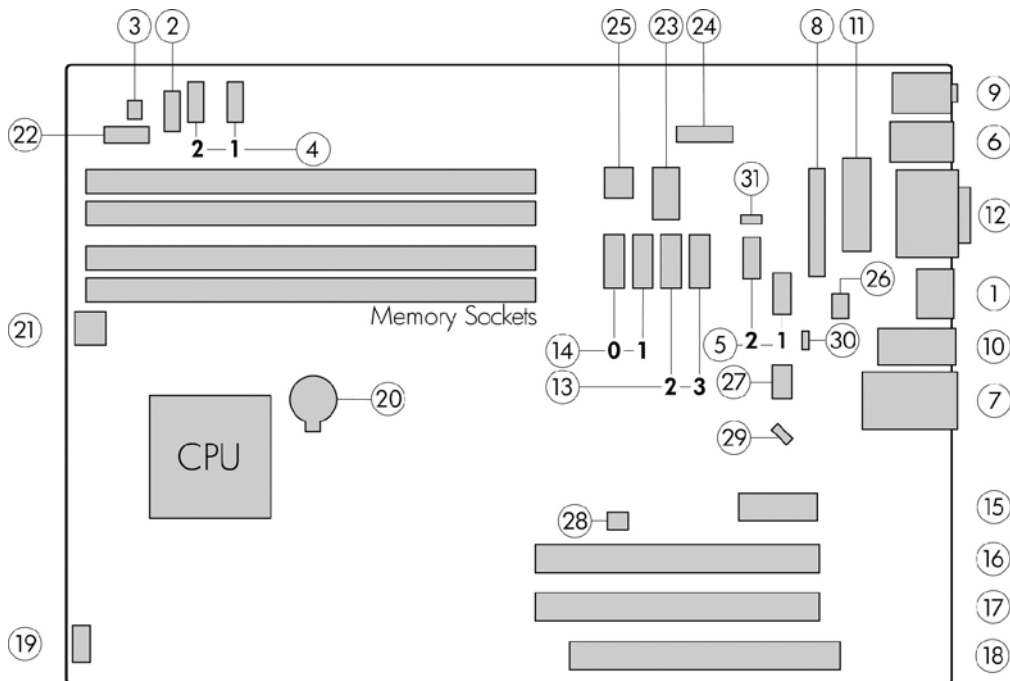

I/O		SATA		Power	
1	Display Port	13	AHCI 3Gb/s	20	Battery
2	Front audio	14	AHCI 6Gb/s	21	CPU power
3	Front speaker	NOTE: Only the port labeled eSATA is eSATA compatible.		22	Front power button/LED
4	Front USB 2.0			23	Main power
5	Internal USB 2.0	PCI/PCIe		24	Power COMM
6	Keyboard/mouse	15	PCIe2 x1	25	SATA power
7	Network/rear USB 2.0	16	PCIe2 x16 (4)	Security	
8	Parallel (optional)	17	PCIe3 x16	26	Chassis solenoid lock
9	Rear audio	18	PCI 32/33	27	Hood sense
10	Rear USB 3.0	NOTE: For related expansion card slot information, see Expansion slots on page 80		Service	
11	Serial (optional)			28	Clear CMOS button
12	VGA/serial	Cooling		29	Crisis recovery jumper
		19	Chassis fan	30	ME/AMT flash override
				31	Password jumper

HP Z220 SFF Workstation system board architecture

This section describes the system architectures.

The following figure shows the typical system board block diagram.

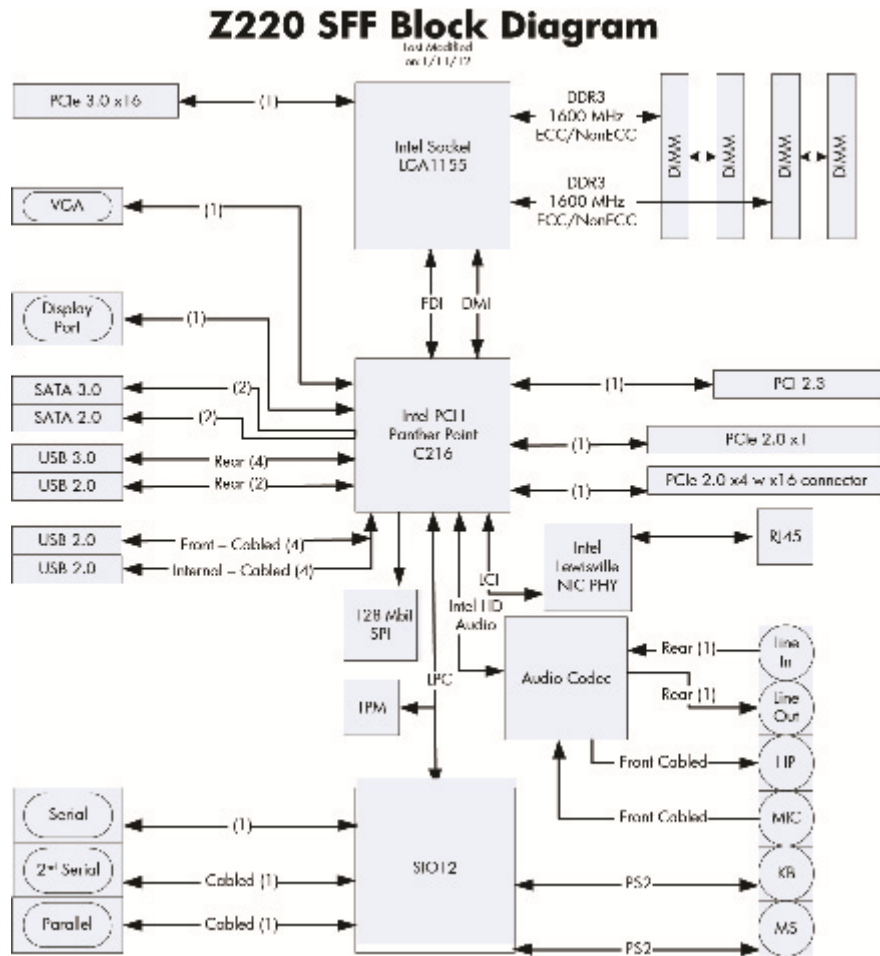

NOTE: The PCIe designators indicate the mechanical connector size and number of electrical PCIe lanes routed to an expansion slot. For example, x16(8) means that the expansion slot is mechanically a x16 length connector, with 8 PCIe lanes supported.

Workstation specifications

HP Z220 SFF	
Processor technology	<p>Intel Series C216 chipset:</p> <ul style="list-style-type: none">• Support for the Intel® Xeon® Processor E3 v2 Family, third-generation Intel Core processors up to 95 W, or Intel Pentium® G640 processors• Integrated 2-channel memory controller• Microarchitecture improvements• Integrated graphics (some models)• Advanced Vector Extensions (AVX) to increase floating point performance• Intel DMI2 interface connecting the processor to the I/O controller
Power supply	<ul style="list-style-type: none">• 240 W, 90% efficient, compatible with ENERGY STAR® Version 5 requirements• Supports European Union ERP Lot 6 tier2 power limit of less than 0.5W in off mode
Memory technology	<ul style="list-style-type: none">• Dual in-line memory modules (DIMMs) based on DDR3 1600 MHz technology• Supports error checking and correcting (ECC) and non-ECC DIMMs• Two direct-attach memory channels enable low-latency access and fast data transfer for improved performance• Up to 32 GB system memory (8 GB DIMMs)• 1600 MHz 2, 4, 8 GB ECC unbuffered DIMM• 1600 MHz 2, 4, 8 GB non ECC unbuffered DIMM
Graphics cards	<p>Supports:</p> <ul style="list-style-type: none">• PCIe Gen3 (PCIe3) bus speeds; can support dual PCIe Gen2 graphics cards in mechanical PCIe x16 slots• Multiple graphics cards, provided their total power usage is within 45 W• Up to two displays with integrated Intel HD graphics (depending on processor type)• Up to four 2D displays or two 3D displays <p>NOTE: Most supported Intel Core processors provide Intel HD Graphics 2000/2500/4000; Intel Xeon processors with model designations that end in "---5" provide Intel HD Graphics P4000.</p> <p>NOTE: To drive more than two displays, use the Computer (F10) Setup Utility to intermix integrated Intel HD graphics and discrete graphics cards (with three or more displays, HP recommends using only discrete graphics cards).</p>
I/O technology	<ul style="list-style-type: none">• RAID configurations for SATA RAID levels 0, 1• Supports eSATA (3.0 Gbps) using an optional adapter• Six external and four internal USB 2.0 ports• Four external USB 3.0 ports• Parallel and serial headers that can be used with an optional PCI bulkhead connector





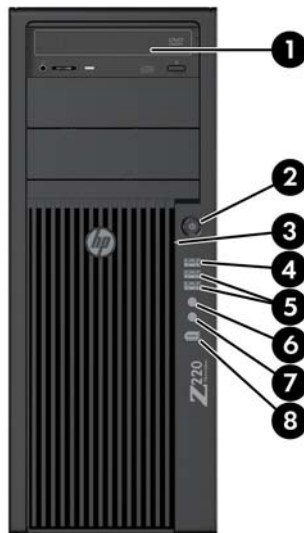

HP Z220 CMT Workstation components

For complete and current information on supported accessories and components for the computer, see <http://partsurfer.hp.com>.

- [HP Z220 CMT Workstation front panel components](#)
- [HP Z220 CMT Workstation rear panel components](#)
- [HP Z220 CMT Workstation chassis components](#)
- [HP Z220 CMT Workstation system board component](#)
- [HP Z220 CMT Workstation system board architecture](#)
- [Workstation specifications](#)









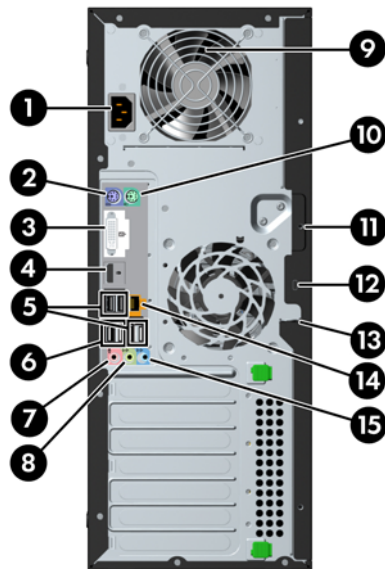

HP Z220 CMT Workstation front panel components





1		Optical drive	5		USB 3.0 ports (2) (blue)
2		Power button	6		Headphone connector
3		Hard drive activity light	7		Microphone connector
4		USB 2.0 ports (1) (black)	8		1394a FireWire® connector (optional and plugged unless configured)

HP Z220 CMT Workstation rear panel components



1	Power cord connector	9	Power supply Built-In Self Test (BIST) LED
2	 PS/2 keyboard connector (purple)	10	 PS/2 mouse connector (green)
3	 DVI-I connector	11	Universal chassis clamp opening
4	 Display Port (DP) connector	12	Cable lock slot
5	 USB 2.0 ports (4) (black)	13	Padlock loop
6	 USB 3.0 ports (2) (blue)	14	 RJ-45 network connector
7	 Microphone connector (pink)	15	 Audio line-in connector (blue)
8	 Audio line-out connector (green)		

 **NOTE:** The DP and DVI-I ports are not supported when the system is configured with Intel Xeon E3-12x0 v2 processors. Also, if a discrete graphics card is installed these ports are disabled by default.

 **NOTE:** Simultaneous usage of integrated Intel HD graphics and discrete graphics cards (in order to drive more than two displays) can be enabled using the Computer (F10) Setup Utility. However, HP recommends using only discrete graphics cards when attaching three or more displays.

HP Z220 CMT Workstation chassis components

The following figure shows the chassis components of a typical HP Z220 CMT Workstation layout. Drive configurations can vary.

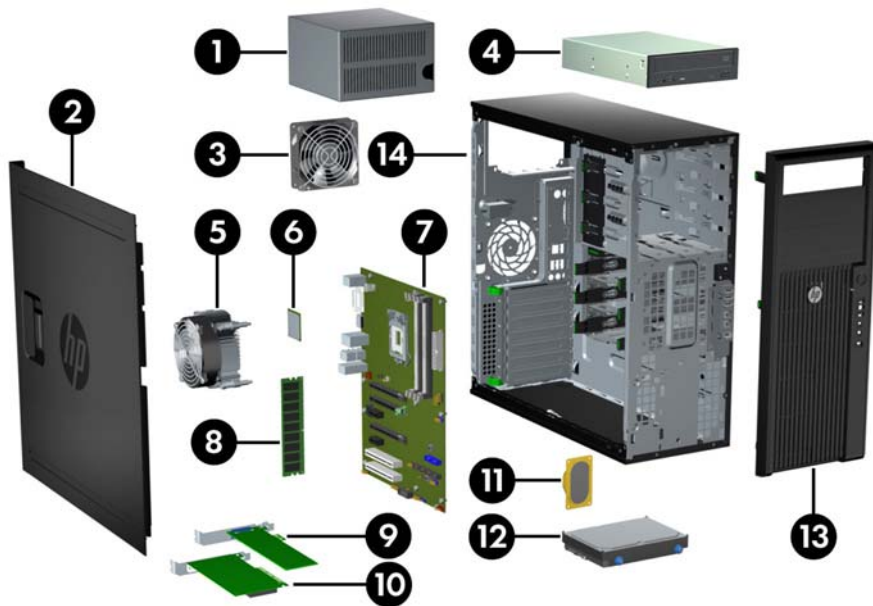

Item	Description	Item	Description
1	Power supply	8	Memory module (DIMM)
2	Side access panel	9	PCIe card
3	Rear system fan	10	PCI card
4	Optical drive	11	Speaker
5	CPU heatsink	12	Hard disk drive
6	CPU	13	Front bezel
7	System board	14	Chassis

HP Z220 CMT Workstation system board component

The following illustration and table identify workstation system board components.

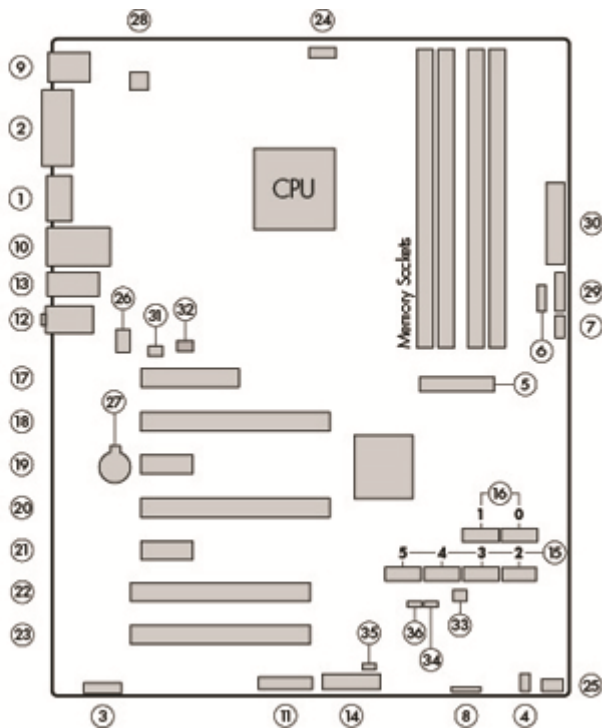

I/O		SATA		Power	
1	Display Port	15	AHCI 3Gb/s	27	Battery
2	DVI video	16	AHCI 6Gb/s	28	CPU power
3	Front audio	PCI/PCIe		29	Front power button/LED
4	Front speaker	17	PCIe2 x8 (4)	30	Main power
5	Front USB 2.0/3.0	18	PCIe3 x16	Security	
6	Internal USB 2.0	19	PCIe2 x1	31	Chassis solenoid lock
7	Internal USB 2.0	20	PCIe2 x16 (4)	32	Hood sense
8	Internal USB 2.0	21	PCIe2 x1	Service	
9	Keyboard/mouse	22	PCI 32/33	33	Clear CMOS button
10	Network/rear USB 2.0	23	PCI 32/33	34	Crisis recovery jumper
11	Parallel (optional)	Cooling		35	ME/AMT flash override
12	Rear audio	24	CPU fan	36	Password jumper
13	Rear USB 2.0/3.0	25	Front fan	NOTE: For related expansion card slot information, see Expansion slots on page 80	
14	Serial (optional)	26	Rear fan		

HP Z220 CMT Workstation system board architecture

The following figure shows the typical system board block diagram.

Z220 CMT Block Diagram

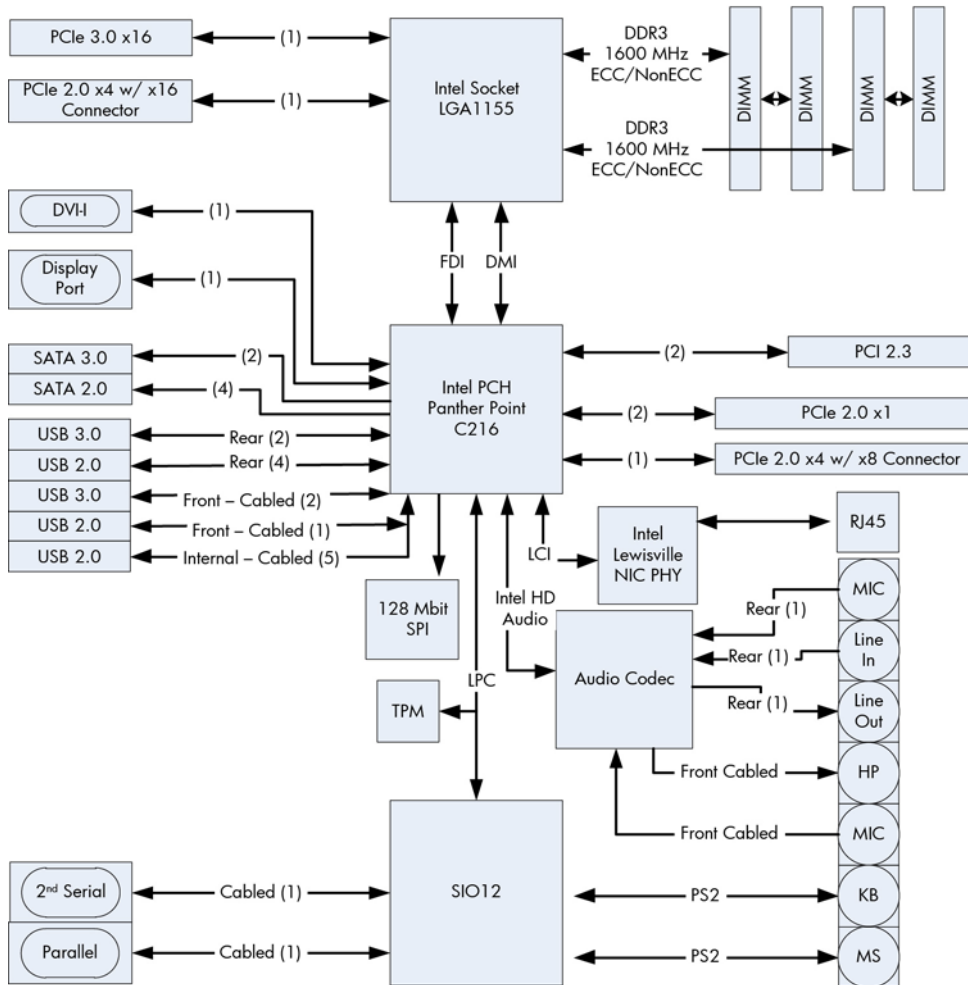

NOTE: The PCIe designators indicate the mechanical connector size and number of electrical PCIe lanes routed to an expansion slot. For example, x16(8) means that the expansion slot is mechanically a x16 length connector, with 8 PCIe lanes supported.

Workstation specifications

HP Z220 CMT	
Processor technology	<p>Intel Series C216 chipset:</p> <ul style="list-style-type: none">• Support for the Intel Xeon Processor E3 v2 Family or third-generation Intel Core processors up to 95 W• Integrated 2-channel memory controller• Microarchitecture improvements• Integrated graphics (some models)• Advanced Vector Extensions (AVX) to increase floating point performance• Intel DMI2 interface connecting the processor to the I/O controller
Power supply	<ul style="list-style-type: none">• 400 W, 90% efficient, compatible with ENERGY STAR Version 5 requirements• Supports European Union ERP Lot 6 tier2 power limit of less than 0.5 W in off mode
Memory technology	<ul style="list-style-type: none">• Dual in-line memory modules (DIMMs) based on DDR3 1600MHz technology• Supports error checking and correcting (ECC) and non-ECC DIMMs• Two direct-attach memory channels enable low-latency access and fast data transfer for improved performance• Up to 32 GB system memory (8 GB DIMMs)• 1600 MHz 2, 4, 8 GB ECC unbuffered DIMM• 1600 MHz 2, 4, 8 GB non ECC unbuffered DIMM
Graphics cards	<p>Supports:</p> <ul style="list-style-type: none">• PCIe Gen3 (PCIe3) bus speeds; can support dual PCIe Gen2 graphics cards in mechanical PCIe x16 slots• Multiple graphics cards, provided their total power usage is within 150 W• Up to two displays with integrated Intel HD graphics (depending on processor type)• Up to four 2D displays or two 3D displays <p>NOTE: Most supported Intel Core processors provide Intel HD Graphics 2000/2500/4000; Intel Xeon processors with model designations that end in "--5" provide Intel HD Graphics P4000.</p> <p>NOTE: To drive more than two displays, use the Computer (F10) Setup Utility to intermix integrated Intel HD graphics and discrete graphics cards (with three or more displays, HP recommends using only discrete graphics cards).</p>
I/O technology	<ul style="list-style-type: none">• RAID configurations for SATA RAID levels 0, 1• Supports eSATA (3.0 Gbps) using an optional adapter• Six external and four internal USB 2.0 ports• Four external USB 3.0 ports• Parallel and serial headers that can be used with an optional PCI bulkhead connector

HP Z420 Workstation components

For complete and current information on supported accessories and components for the computer, see <http://partsurfer.hp.com>.

- [HP Z420 Workstation front panel](#)
- [HP Z420 Workstation rear panel](#)
- [HP Z420 Workstation chassis components](#)
- [HP Z420 Workstation system board components](#)
- [HP Z420 Workstation system board architecture](#)
- [HP Z420 Workstation specifications](#)



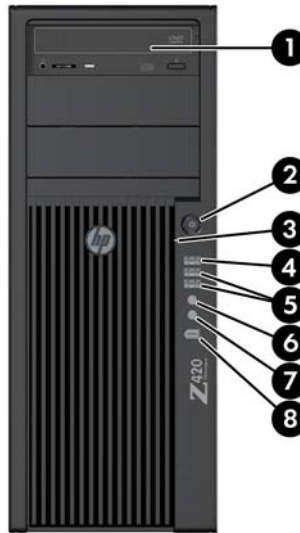





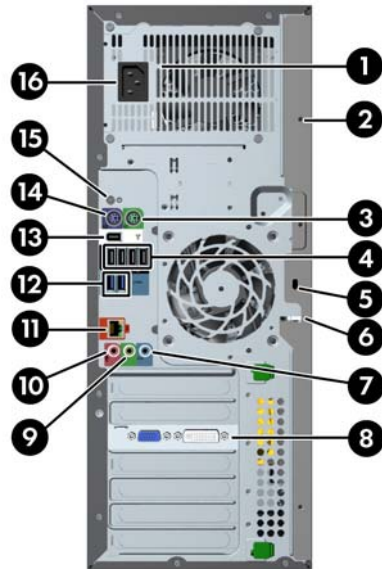

HP Z420 Workstation front panel



1		Optical drive	5		USB 3.0 ports (2, blue)
2		Power button	6		Headphone connector
3		Hard drive activity light	7		Microphone connector
4		USB 2.0 port (black)	8		IEEE-1394a FireWire® connector

HP Z420 Workstation rear panel



1	Power supply Built-In Self Test (BIST) LED	9		Audio line-out connector (green)
2	Universal chassis clamp opening	10		Microphone connector (pink)
3	 PS/2 mouse connector (green)	11		AMT-enabled RJ-45 network connector (orange)
4	 USB 2.0 ports (4, black)	12		USB 3.0 ports (2, blue)
5	Security slot	13		IEEE-1394a FireWire connector (white)
6	Padlock loop	14		PS/2 keyboard connector (purple)
7	 Audio line-in connector (blue)	15		Rear power button
8	Graphics card connector	16		Power cord connector

HP Z420 Workstation chassis components

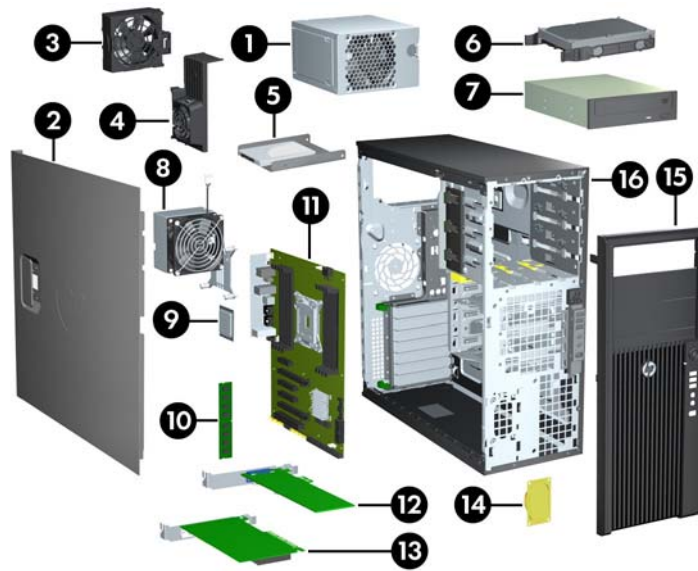

1	Power supply	9	CPU
2	Side access panel	10	Memory module (DIMM)
3	Rear system fan	11	System board
4	Memory airflow guide	12	PCIe card
5	Hard disk drive	13	PCI card
6	Hard disk drive	14	Speaker
7	Optical drive	15	Front bezel
8	Heatsink	16	Chassis

HP Z420 Workstation system board components

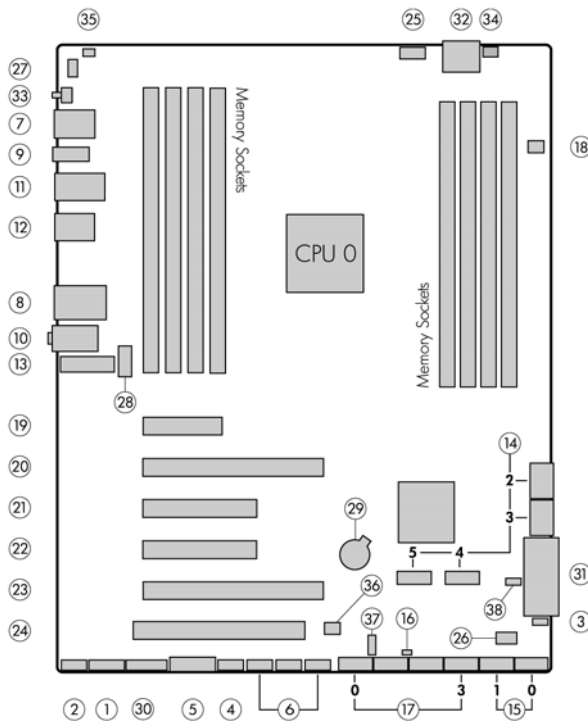

I/O	SATA (SAS optional)	Cooling	Security
1 Front 1394a	14 AHCI 3Gb/s	25 CPU0 fan	34 Chassis solenoid lock
2 Front audio	15 AHCI 6Gb/s	26 Front fan	35 Chassis intrusion sensor
3 Front speaker	16 HDD LED	27 Memory fan	Service
4 Front USB 2.0	17 SCU 3Gb/s	28 Rear fan	36 Clear CMOS button
5 Front USB 3.0	18 SAS (optional)	Power	37 ME/AMT flash override
6 Internal USB 2.0	PCI/PCIe	29 Battery	38 Password jumper
7 Keyboard/mouse	19 PCIe2 x4 (1)	30 Front power button/LED	
8 Network	20 PCIe3 x16	31 Main power	
9 Rear 1394a	21 PCIe2 x8 (4)	32 CPU/MEM power	
10 Rear audio	22 PCIe3 x8	33 Rear power button/LED	
11 Rear USB 2.0	23 PCIe3 x16	For related expansion card slot information, see Expansion slots on page 80	
12 Rear USB 3.0	24 PCI 32/33		
13 Serial (optional)			

HP Z420 Workstation system board architecture

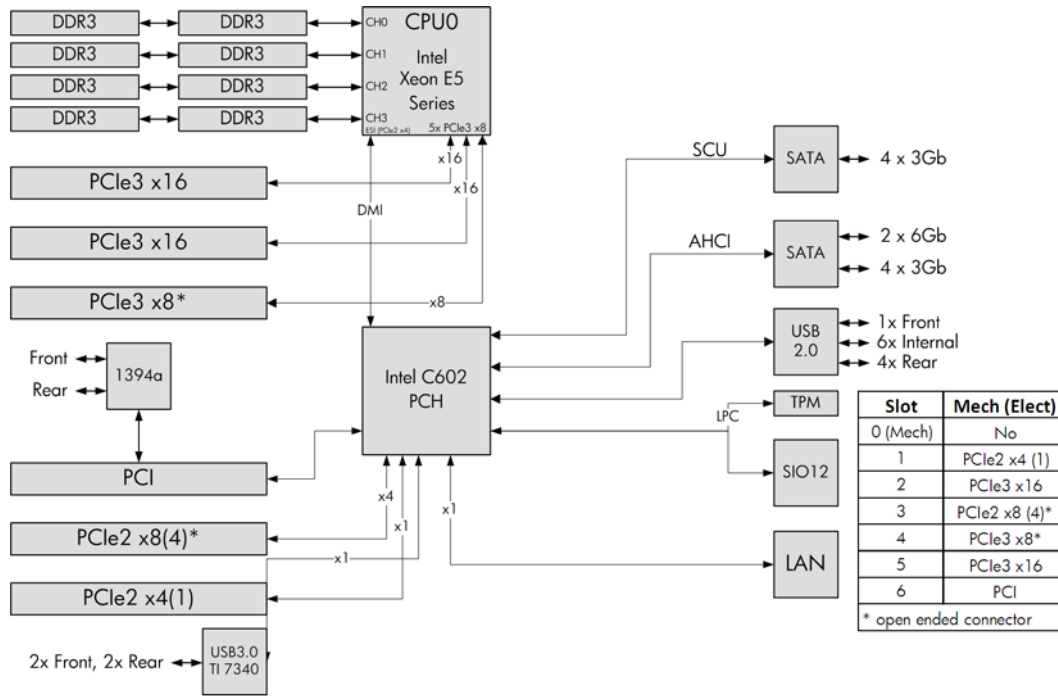

NOTE: The PCIe designators indicate the mechanical connector size and number of electrical PCIe lanes routed to an expansion slot. For example, x16(8) means that the expansion slot is mechanically a x16 length connector, with 8 PCIe lanes supported.

HP Z420 Workstation specifications

Processor technology	<p>Intel Series C602 chipset:</p> <ul style="list-style-type: none">• Support for the Intel Xeon Processor E5-1600 Series and E5-2600 Series, including processors up to 150 W• Integrated 4-channel memory controller• Microarchitecture improvements• Large L3 cache for superior performance• Intel QuickPath Interconnect (QPI) connects processors and I/O controller with speeds up to 8 GT/s <p><i>HP Liquid Cooling option is available for all Z420 processors and is required on the E5-2687W processor model.</i></p>
Power supply	<ul style="list-style-type: none">• 600 W Gold, 90% efficient, wide-ranging, active Power Factor Correction, one auxiliary dongle on a 12V rail, ERP 0.5W, Built-in-Self Test (BIST)• 400 W Gold, 90% efficient, wide-ranging, active Power Factor Correction, ERP 0.5W, Built-in-Self Test (BIST)
Memory technology	<ul style="list-style-type: none">• Dual in-line memory modules (DIMMs) based on DDR3 1600 MHz technology• Error checking and correcting (ECC)-protected• Four direct-attach memory channels enable low-latency access and fast data transfer for improved performance• Up to 64 GB system memory (8 GB DIMMs)• 1600 MHz 2, 4, 8 GB ECC unbuffered DIMMs <p>NOTE: Do not mix any of the different types (unbuffered, registered, and load reducing DIMMs) of memory. The system will not boot and will produce a memory error.</p> <p>NOTE: Distribute DIMMs across all memory channels for optimal performance.</p>
Graphics cards	<p>Supports:</p> <ul style="list-style-type: none">• PCIe Gen3 (PCIe3) bus speeds; can support two PCIe Gen3 graphics cards in PCIe3 x16 slots• Up to 225 W graphics or compute card in the primary graphics slot (600 W PSU)• Up to 75 W graphics in primary slot (400 W PSU)• A second graphics card in the second PCIe3 x16 slot• Third and fourth 2D graphics cards in additional PCIe2 slots• Combined power consumption of all cards not to exceed 270 W (subject to overall system power limitations and configuration restrictions) (600 W PSU)• Combined power consumption of all cards not to exceed 75 W (subject to overall system power limitations and configuration restrictions) (400 W PSU)
I/O technology	<ul style="list-style-type: none">• SATA RAID 0/1/5/10 on AHCI• Ten SATA ports (2 AHCI 6 Gb/s, 4 AHCI 3 Gb/s, 4 SCU 3 Gb/s)• Two ports capable of optional eSATA• Four external USB 3.0 ports (2 front, 2 rear)• Five external USB 2.0 ports (1 front, 4 rear)• Six internal USB 2.0 ports

	<ul style="list-style-type: none"> • Serial Attached SCSI (SAS) drives supported with 9212-4i plug-in card 				
Weight	<ul style="list-style-type: none"> • Standard configuration: 13.2 kg (29.2 lb) • Minimum configuration: 12.5 kg (27.5 lb) • Maximum configuration: 17.7 kg (39.4 lb) 				
Chassis dimensions	<table> <tr> <td>Tower configuration:</td> <td>Desktop configuration:</td> </tr> <tr> <td> <ul style="list-style-type: none"> • Height: 44.76 cm (17.62 in) • Width: 17.78 cm (7.00 in) • Depth: 44.50 cm (17.53 in) </td> <td> <ul style="list-style-type: none"> • Height: 17.78 cm (7.00 in) • Width: 44.76 cm (17.62 in) • Depth: 44.50 cm (17.53 in) </td> </tr> </table>	Tower configuration:	Desktop configuration:	<ul style="list-style-type: none"> • Height: 44.76 cm (17.62 in) • Width: 17.78 cm (7.00 in) • Depth: 44.50 cm (17.53 in) 	<ul style="list-style-type: none"> • Height: 17.78 cm (7.00 in) • Width: 44.76 cm (17.62 in) • Depth: 44.50 cm (17.53 in)
Tower configuration:	Desktop configuration:				
<ul style="list-style-type: none"> • Height: 44.76 cm (17.62 in) • Width: 17.78 cm (7.00 in) • Depth: 44.50 cm (17.53 in) 	<ul style="list-style-type: none"> • Height: 17.78 cm (7.00 in) • Width: 44.76 cm (17.62 in) • Depth: 44.50 cm (17.53 in) 				



HP Z620 Workstation components

For complete and current information on supported accessories and components for the computer, see <http://partsurfer.hp.com>.

- [HP Z620 Workstation front panel](#)
- [HP Z620 Workstation rear panel](#)
- [HP Z620 Workstation chassis components](#)
- [HP Z620 Workstation system board components](#)
- [HP Z620 Workstation system board architecture](#)
- [HP Z620 Workstation specifications](#)

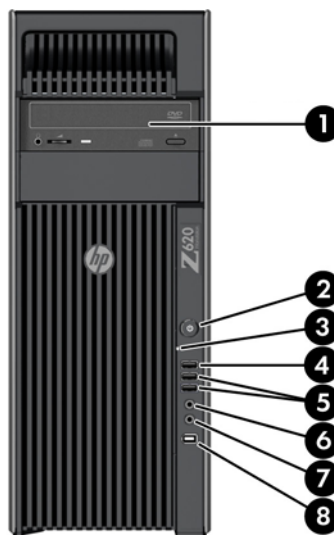







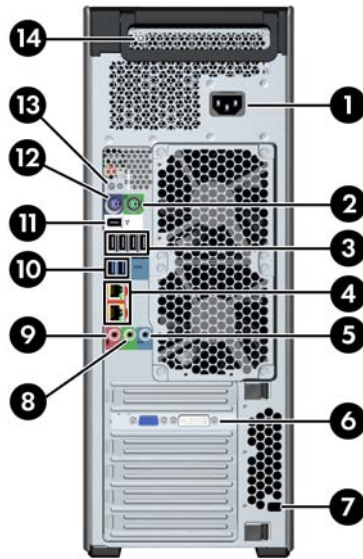

HP Z620 Workstation front panel



1	Optical drive	5		USB 3.0 ports (2, blue)
2	 Power button	6		Headphone connector
3	 Hard drive activity light	7		Microphone connector
4	 USB 2.0 port (black)	8		IEEE-1394a FireWire connector

HP Z620 Workstation rear panel



1	Power cord connector	8	 Audio line-out connector (green)
2	 PS/2 mouse connector (green)	9	 Microphone connector (pink)
3	 USB 2.0 ports (4, black)	10	 USB 3.0 ports (2, blue)
4	 RJ-45 network connectors (orange) <i>Bottom connector is AMT enabled</i>	11	 IEEE-1394a connector (white)
5	 Audio line-in connector (blue)	12	 PS/2 keyboard connector (purple)
6	Graphics card connector	13	 Rear power button
7	Security slot	14	Power supply Built-In Self Test (BIST) LED

HP Z620 Workstation chassis components

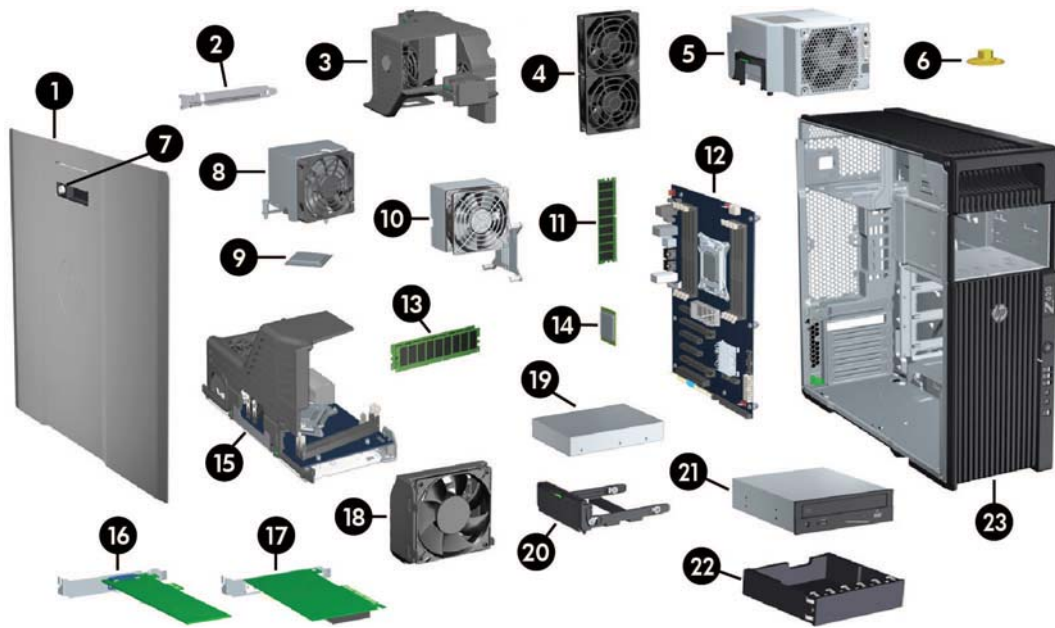

1	Side access panel	13	Second CPU memory module (DIMM) (optional)
2	Second CPU module rear guide bracket	14	CPU
3	Memory fans	15	Second CPU module (optional)
4	Rear system fans	16	PCIe card
5	Power supply	17	PCI card
6	Speaker	18	Card guide and front fan
7	Side access panel key lock	19	Hard disk drive
8	Second CPU heatsink (optional)	20	Hard disk drive carrier
9	Second CPU (optional)	21	Optical drive
10	CPU heatsink	22	External bay filler
11	Memory module (DIMM)	23	Chassis
12	System board		

HP Z620 Workstation system board components

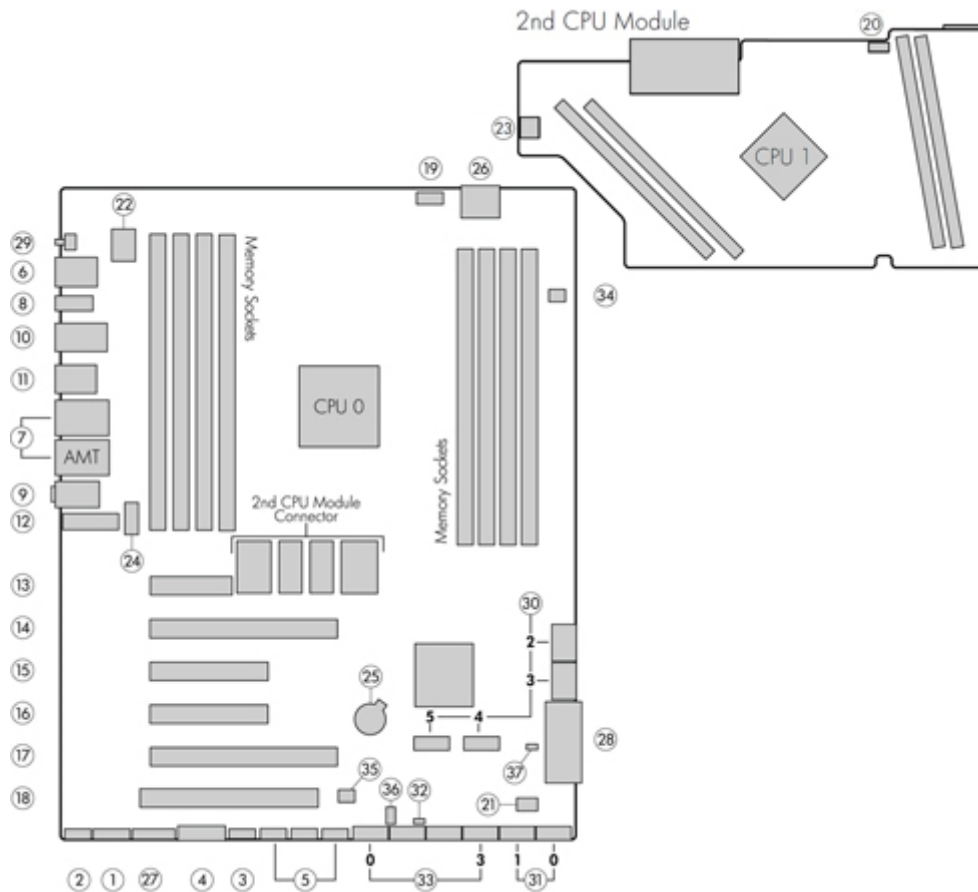

I/O		PCI/PCIe		Power	
1	Front 1394a	13	PCIe2 x4 (1)	25	Battery
2	Front audio	14	PCIe3 x16	26	CPU and memory power
3	Front USB 2.0	15	PCIe2 x8 (4)	27	Front power button, LED, speaker
4	Front USB 3.0	16	PCIe3 x8	28	Main power
5	Internal USB 2.0	17	PCIe3 x 16	29	Rear power button/LED
6	Keyboard/mouse	18	PCI 32/33	SATA (SAS optional)	
7	Network	Cooling		30	AHCI 3Gb/s
8	Rear 1394a	19	CPU0 memory fan	31	AHCI 6Gb/s
9	Rear audio	20	CPU1 memory fan	32	Hard disk drive LED
10	Rear USB 2.0	21	Front fan	33	SCU 3Gb/s
11	Rear USB 3.0	22	CPU0 memory fan	34	SAS (optional)
12	Serial (optional)	23	CPU1 memory fan (optional)	Service	
		24	Rear fans	35	Clear CMOS button

HP Z620 Workstation system board architecture

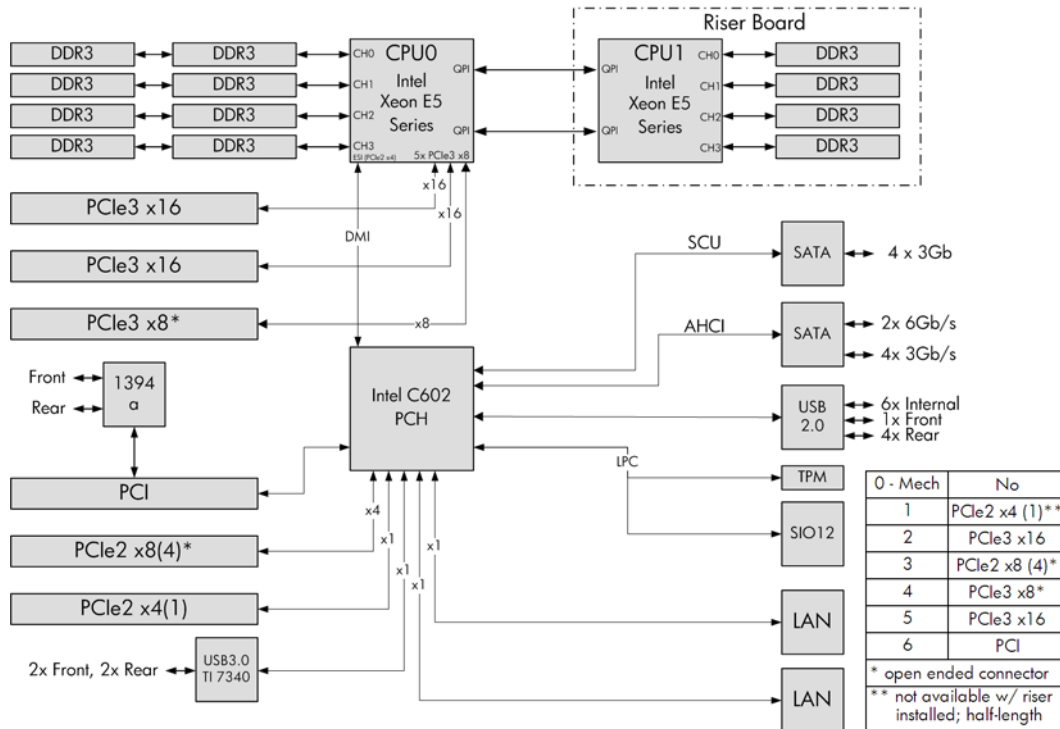

NOTE: The PCIe designators indicate the mechanical connector size and number of electrical PCIe lanes routed to an expansion slot. For example, x16 (8) means that the expansion slot is mechanically a x16 length connector, with 8 PCIe lanes supported.

HP Z620 Workstation specifications

Processor technology	<p>Intel Series C602 chipset:</p> <ul style="list-style-type: none">• Support for the Intel Xeon Processor E5-1600 Series and E5-2600 Series• Integrated 4-channel memory controller• Microarchitecture improvements• Large L3 cache for superior performance• Intel QuickPath Interconnect (QPI) connects processors and I/O controller with speeds up to 8 GT/s
Power supply	<ul style="list-style-type: none">• 800 W Gold, 90% efficient, wide-ranging, active Power Factor Correction, two auxiliary dongles on two separate 12V rails, ERP 0.5W, Built-in-Self Test (BIST)
Memory technology	<ul style="list-style-type: none">• Dual in-line memory modules (DIMMs) based on DDR3 1600 MHz technology• Error checking and correcting (ECC)-protected• Eight direct-attach memory channels (four per CPU) enable low-latency access and fast data transfer for improved performance• Configurations with one CPU have eight DIMM slots; a second CPU adds four more DIMM slots• With one processor, up to 64 GB system memory (8 GB DIMMs)• With second processor, up to 96 GB system memory (8 GB DIMMs)• 1600 MHz 2, 4 GB ECC unbuffered DIMMs• 1600 MHz 4, 8 GB ECC registered DIMMs <p>NOTE: Do not mix any of the different types (unbuffered, registered, and load reducing DIMMs) of memory. The system will not boot and will produce a memory error.</p> <p>NOTE: For maximum performance, on workstations with two CPUs, install the same number of DIMMs per CPU and install them in pairs of the same size.</p> <p>NOTE: Distribute DIMMs across all memory channels for optimal performance.</p>
Graphics cards	<ul style="list-style-type: none">• PCIe Gen3 (PCIe3) bus speeds; can support two PCIe Gen3 graphics cards in PCIe3 x16 slots• Up to 225 W graphics or compute card in the primary graphics slot• A second graphics card in the second PCIe3 x16 slot• Third and fourth 2D graphics cards in additional PCIe2 slots• Combined power consumption of all cards cannot exceed 300 W (subject to overall system power limitations and configuration restrictions)
I/O technology	<ul style="list-style-type: none">• SATA RAID 0/1/5/10 on AHCI• Ten SATA ports (2 AHCI 6 Gb/s, 4 AHCI 3 Gb/s, 4 SCU 3 Gb/s)• Two ports available for optional eSATA• Four external USB 3.0 ports (2 front, 2 rear)• Five external USB 2.0 ports (1 front, 4 rear)• Six internal USB 2.0 ports
Weight	<ul style="list-style-type: none">• Standard configuration: 17.9 kg (39.4 lb)• Minimum configuration: 15.5 kg (34.2 lb)

	<ul style="list-style-type: none">• Maximum configuration: 22.6 kg (49.9 lb)
Chassis dimensions	<ul style="list-style-type: none">• Height: 44.45 cm (17.50 in)
	<ul style="list-style-type: none">• Width: 17.15 cm (6.75 in)
	<ul style="list-style-type: none">• Depth: 46.48 cm (18.30 in)

HP Z820 Workstation components

For information on supported accessories and components, see <http://partsurfer.hp.com>.

- [HP Z820 Workstation front panel](#)
- [HP Z820 Workstation rear panel](#)
- [HP Z820 Workstation chassis components](#)
- [HP Z820 Workstation system board components](#)
- [HP Z820 Workstation system board architecture](#)
- [HP Z820 Workstation specifications](#)



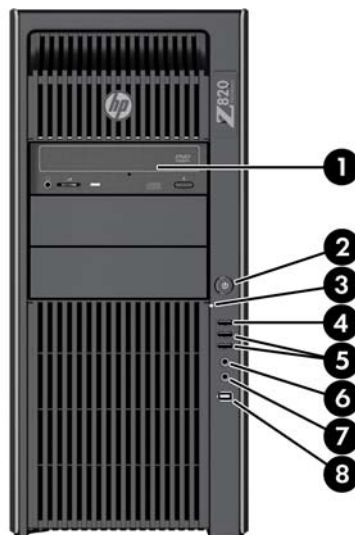





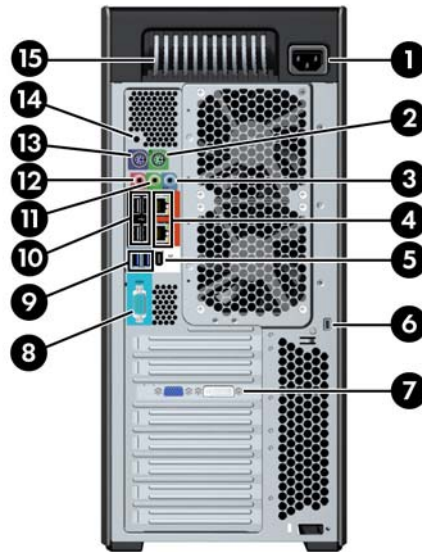

HP Z820 Workstation front panel



1	Optical drive	5		USB 3.0 ports (2, blue)
2	 Power button	6		Headphone connector
3	 Hard drive activity light	7		Microphone connector
4	 USB 2.0 port (black)	8		IEEE-1394a FireWire connector

HP Z820 Workstation rear panel



1	Power cord connector	9	 USB 3.0 ports (2, blue)
2	 PS/2 mouse connector (green)	10	 USB 2.0 ports (4, black)
3	 Audio line-in connector (blue)	11	 Audio line-out connector (green)
4	 RJ-45 network connectors (2, orange) <i>Top connector is AMT enabled</i>	12	 Microphone connector (pink)
5	 IEEE-1394a FireWire connector (white)	13	 PS/2 keyboard connector (purple)
6	Security slot	14	 Rear power button
7	Graphics card connector(s)	15	Power supply Built-In Self Test (BIST) LED
8	 Serial connector (teal blue)		

HP Z820 Workstation chassis components

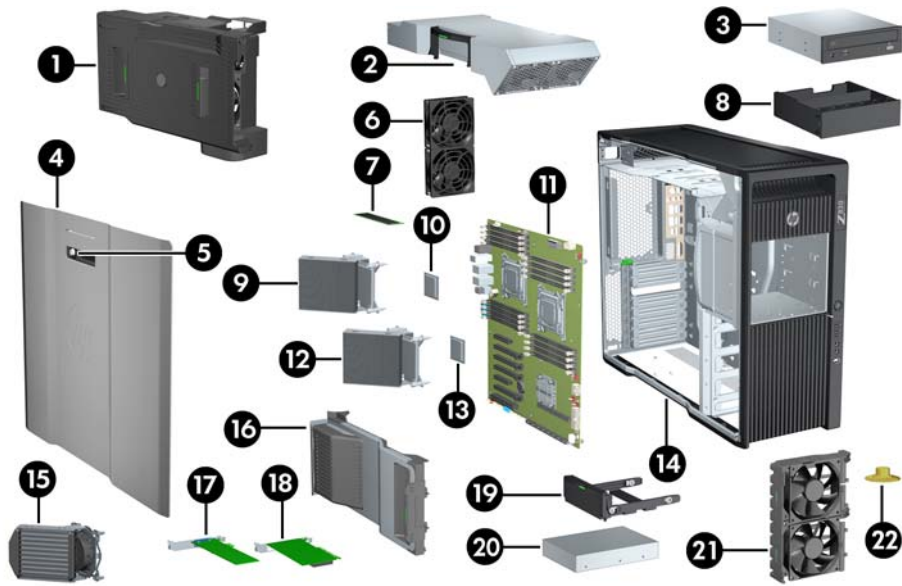

1	CPU/memory fans	12	Processor (CPU) heatsink
2	Power supply	13	Processor (CPU)
3	Optical drive	14	Chassis
4	Side access panel	15	Processor (CPU) liquid cooling unit (optional upgrade to standard heatsink)
5	Side access panel key lock	16	PCI Retainer
6	Rear system fans	17	PCIe card
7	Memory module (DIMM)	18	PCI card
8	Front bay filler (optional)	19	Hard disk drive carrier
9	Second processor (CPU) heatsink (optional)	20	Hard disk drive
10	Second processor (CPU) (optional)	21	Front system fan unit (two fans with 1125 W power supply)
11	System board	22	Speaker

HP Z820 Workstation system board components

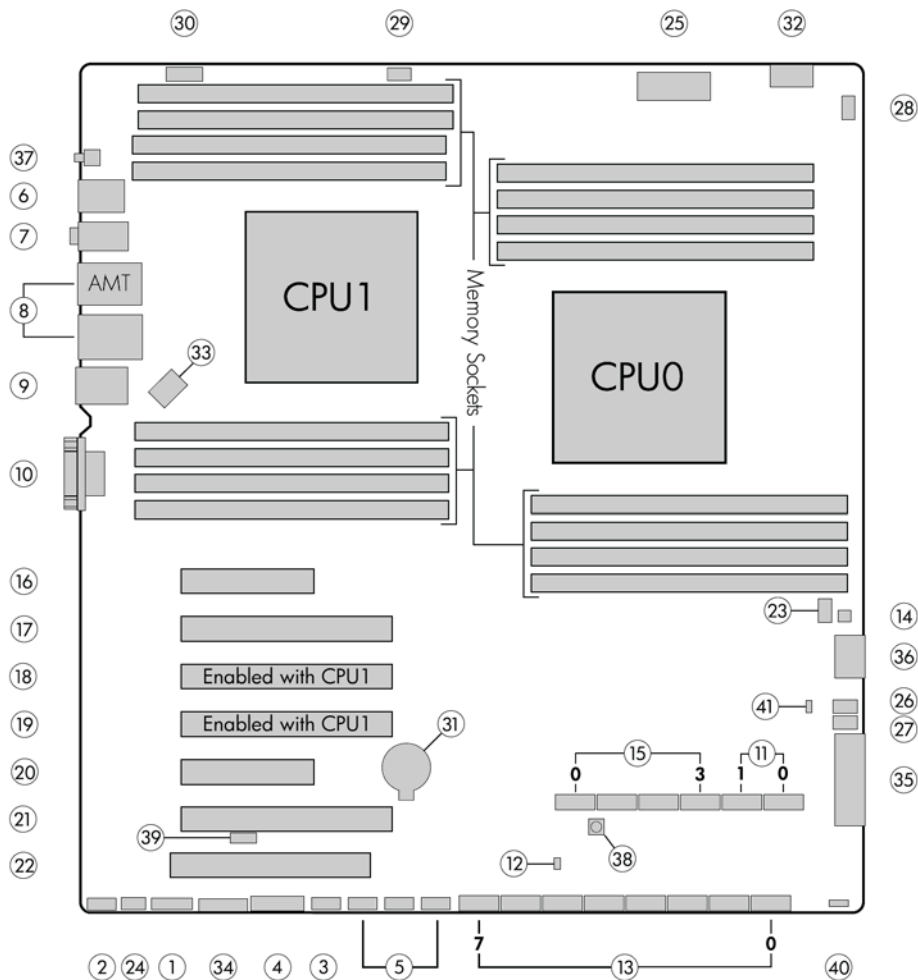

I/O		PCI/PCIe		Power	
1	Front 1394a	16	PCIe3 x8 (4) — CPU0	31	Battery
2	Front audio	17	PCIe3 x16 — CPU0	32	CPU0 power
3	Front USB 2.0	18	PCIe3 x16 (8) — CPU1	33	CPU1 power
4	Front USB 3.0	19	PCIe3 x16 — CPU1	34	Front power button /LED/ speaker
5	Internal USB 2.0	20	PCIe2 x8 (4) — CPU0	35	Main power
6	Keyboard/mouse	21	PCIe3 x16 — CPU0	36	Memory power
7	Rear audio	22	PCI 32/33 — CPU0	37	Rear power button /LED
8	Rear USB 2.0/Network	Cooling		Service	
9	Rear USB 3.0/1394a	23	Auxiliary fan 1 (front)	38	Clear CMOS button
10	Serial	24	Auxiliary fan 2 (rear)	39	Crisis recovery jumper
SAS/SATA		25	CPU/memory fans	40	ME/AMT Flash override
11	AHCI 6Gb/s	26	Front fan 1 (top)	41	Password jumper

12	Hard disk drive LED	27	Front fan 2 (bottom)
13	SAS/SATA 6Gb/s	28	Liquid cooling 0 power
14	SAS (optional)	29	Liquid cooling 1 power
15	SCU 3Gb/s	30	Rear chassis fans

NOTE: For related expansion card slot information, see [Expansion slots on page 80](#).

HP Z820 Workstation system board architecture

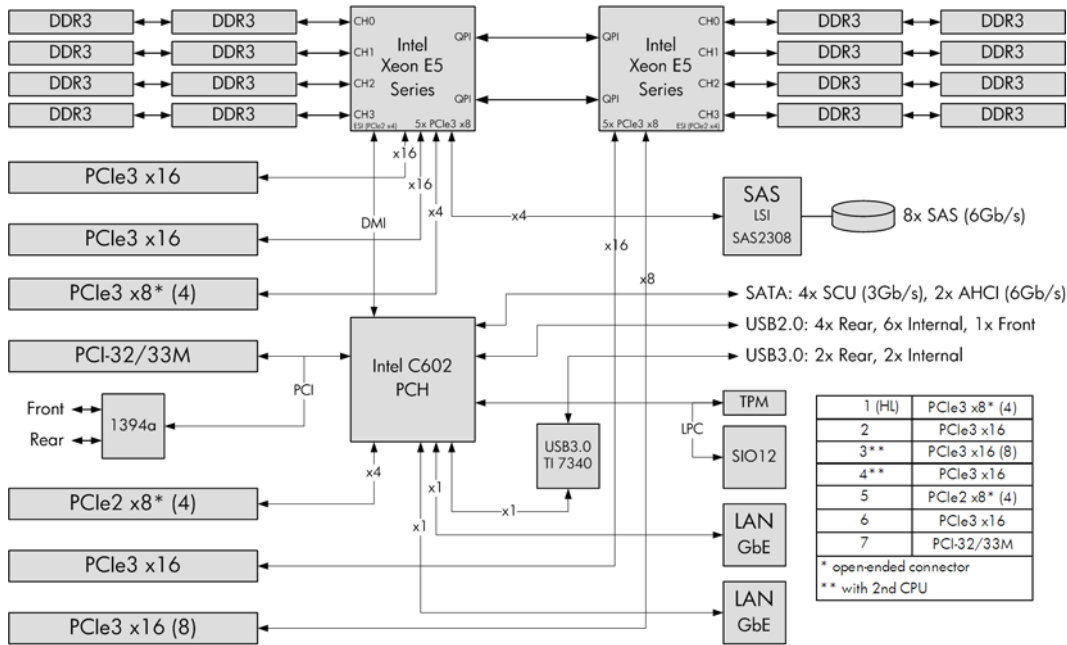

NOTE: The PCIe designators indicate the mechanical connector size and number of electrical PCIe lanes routed to an expansion slot. For example, x16(8) means that the expansion slot is mechanically a x16 length connector, with 8 PCIe lanes supported.

HP Z820 Workstation specifications

Processor technology	<p>Intel Series C602 chipset:</p> <ul style="list-style-type: none">• Support for the Intel Xeon Processor E5-2600 Series, including processors up to 150 W• Integrated 4-channel memory controller• Microarchitecture improvements• Large L3 cache for superior performance• Intel QuickPath Interconnect (QPI) connects processors and I/O controller with speeds up to 8.0 GT/s <p>NOTE: <i>HP Liquid Cooling option is available for all Z820 processors.</i></p>
Power supply	<ul style="list-style-type: none">• 850 W Silver, 88% efficient, wide-ranging, active Power Factor Correction, two auxiliary dongles on two separate 12V rail, ERP 0.5W, Built-in-Self Test (BIST)• 1125 W Gold, 90% efficient, wide-ranging, active Power Factor Correction, three auxiliary dongles on three separate 12V rails, ERP 0.5W, Built-in-Self Test (BIST)• China's Energy Conservation Program (CECP) configurations• European Union ErP LOT6 2013 power limit of 0.5 W in off mode
Memory technology	<ul style="list-style-type: none">• Dual in-line memory modules (DIMMs) based on DDR3 1600MHz technology• Error checking and correcting (ECC)-protected• Eight direct-attach memory channels (four per CPU) enable low-latency access and fast data transfer for improved performance• Configurations with one CPU have eight DIMM slots; a second CPU adds eight more DIMM slots• With one processor, up to 256 GB system memory (32 GB DIMMs)• With second processor, up to 512 GB system memory (32 GB DIMMs)• 1600 MHz 2, 4 GB ECC unbuffered DIMM• 1600 MHz 4, 8, 16 GB ECC registered DIMM• 1333 MHz 32 GB ECC Load Reducing DIMM (available second half of 2012) <p>NOTE: Do not mix any of the different types (unbuffered, registered, and load reducing DIMMs) of memory. The system will not boot and will produce a memory error.</p> <p>NOTE: For maximum performance, on workstations with two CPUs, install the same number of DIMMs per CPU and install them in pairs of the same size</p> <p>NOTE: Distribute DIMMs across all memory channels for optimal performance</p>
Graphics cards	<ul style="list-style-type: none">• PCIe Gen3 (PCIe3) bus speeds; can support three PCIe Gen3 graphics cards in PCIe3 x16 slots• Up to one 160 W or two 75 W graphics cards with 850 W power supply• Up to two 300 W or three 225 W graphics cards with optional 1125 W power supply (other configuration restrictions may be required)
I/O technology	<ul style="list-style-type: none">• SATA RAID 0/1/5/10 on SCU• SAS RAID 0/1/10 on LSI SAS 2308 controller• Six SATA ports: four SCU (3 GB/s); two AHCI (6 GB/s)• Eight SAS ports (6 GB/s)• Two ports (6.0 GB/s) available for optional eSATA

	<ul style="list-style-type: none"> • Four external USB 3.0 ports • Five external and six internal USB 2.0 ports
Weight	<ul style="list-style-type: none"> • Standard configuration: 26.6 kg (58.7 lb) • Minimum configuration: 24.0 kg (52.9 lb) • Maximum configuration: 32.0 kg (70.5 lb)
Chassis dimensions	<ul style="list-style-type: none"> • Height: 44.4 cm (17.5 in) • Width: 20.3 cm (8.0 in) • Depth: 52.5 cm (20.7 in)

Environmental specifications

The following table lists the environmental specifications of HP Workstations.

Temperature	<p>Operating: 5 to 35°C (40 to 95°F)</p> <p>Non-operating: -40 to 60°C (-40 to 140°F)</p> <p>NOTE: Derate by one degree C (1.8 degrees F) for every 305 m (1,000 ft) altitude over 1,524 m (5,000 ft).</p>
Humidity	<p>Operating: 8 to 85% Relative Humidity (RH), non-condensing</p> <p>Non-operating: 8 to 90% Relative Humidity (RH), non-condensing</p>
Altitude	<p>Operating: 0 to 3,048 m (10,000 ft)</p> <p>Non-operating: 0 to 9,144 m (30,000 ft)</p>
Shock	<p>Operating: ½-sine: 40<i>g</i>, 2-3 ms (~62 cm/sec)</p> <p>Non-operating:</p> <ul style="list-style-type: none"> • ½-sine: 160 cm/s, 2-3 ms (~105 <i>g</i>) • square: 422 cm/s, 20 <i>g</i> <p>NOTE: Values represent individual shock events and do not indicate repetitive shock events.</p>
Vibration	<p>Operating Random: 0.5 <i>g</i> (rms), 5-300 Hz, up to 0.0025 <i>g</i>²/Hz</p> <p>Non-Operating: random: 2.0 <i>g</i> (rms), 10-500 Hz, up to 0.0150 <i>g</i>²/Hz</p> <p>NOTE: Values do not indicate continuous vibration.</p>

Ensuring proper ventilation

Proper ventilation for the system is important for workstation operation. Follow these guidelines:

- Operate the workstation on a sturdy, level surface.
- Provide at least 15.24 cm (6 inches) of clearance at the front and back of the workstation. (Workstation models vary.)

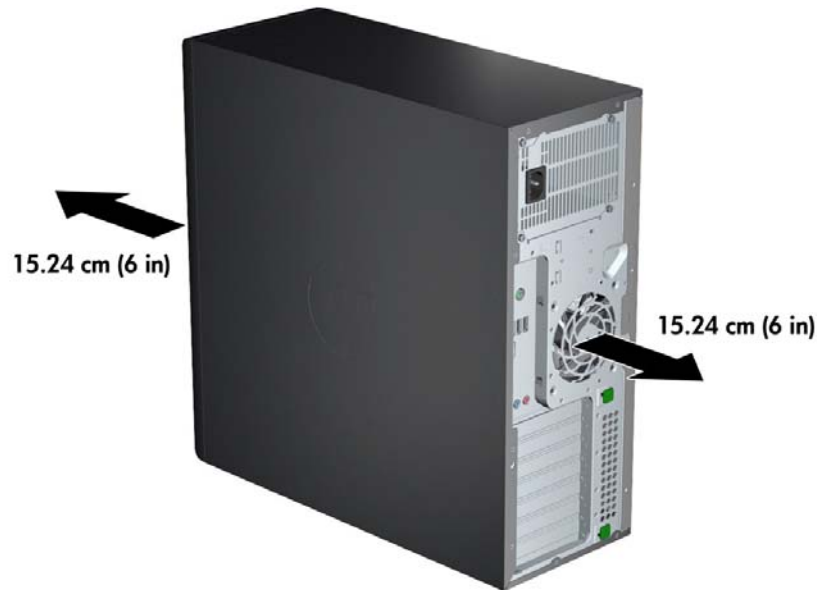

- Ensure that the ambient air temperature falls within the environmental specifications listed in this document.

 **NOTE:** The ambient upper limit of 35°C (95°F) is only good up to 1524 m (5000 ft) elevation. There is a 1°C (33.8°F) per 304.8 m (1000 ft) derating above 1524 m (5000 ft). So, at 3,048 m (10,000 ft), the upper ambient air temperature limit is 30°C (86°F).

- For cabinet installation, ensure adequate cabinet ventilation and ensure that the ambient temperature within the cabinet does not exceed specified limits.
- Never restrict the incoming or outgoing airflow of the workstation by blocking any vents or air intakes, as shown in the following figure.

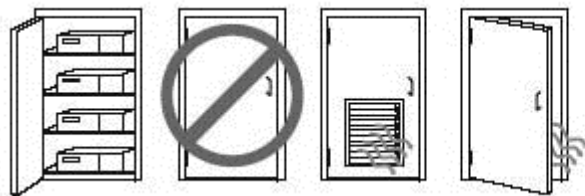

2 System management

This section describes the tools and utilities that provide system management for the workstation.

- [Power management and performance features](#)
- [BIOS ROM](#)
- [Computer Setup \(F10\) Utility](#)
- [Desktop management](#)

Power management and performance features

ERP compliance mode

This computer provides ERP compliance mode capability.

When enabled, the computer shuts down to the lowest possible power state. The computer must then be turned on with the power button. One of the effects is that "wake on LAN" is disabled.

When disabled, the computer powers down conventionally.

Enabling ERP compliance mode	<ol style="list-style-type: none">1. Press F10 during startup.2. Using the arrow keys, select the Power > Hardware Power Management > S5 Maximum Power Savings, then select Enable.3. Press F10 to accept the change.4. Select File > Save Change and Exit, and then press Enter to accept the change.5. If using Windows 8, boot to Windows and search from the Start page for the setting Change what the power buttons do. Uncheck Turn on fast startup (recommended). If the checkbox is not available, click Change settings that are currently unavailable at the top of the window.
Disabling ERP compliance mode	<ol style="list-style-type: none">1. Press F10 during startup.2. Using the arrow keys, select Power > Hardware Power Management > S5 Maximum Power Savings, then select Disable.3. Press F10 to accept the change.4. Select File > Save Change and Exit, and then press Enter to accept the change.5. If using Windows 8, boot to Windows and search from the Start page for the setting Change what the power buttons do. Check Turn on fast startup (recommended). If the checkbox is not available, click Change settings that are currently unavailable at the top of the window.

Hyper-Threading Technology (HTT)

This computer supports HTT, an Intel-proprietary technology that improves processor performance through parallelization of computations (doing multiple tasks at once).

The operating system treats an HTT-enabled processor as two virtual processors, and shares the workload between them when possible. This feature requires that the operating system support multiple processors and be specifically optimized for HTT.

Use the Computer Setup (F10) Utility to enable HTT.

Go to <http://www.hp.com/go/quickspecs> to determine if your CPU supports HTT.

SATA Power Management

SATA Power Management enables or disables SATA bus and/or device power management.

Intel Turbo Boost Technology

The HP Z Workstation series supports Intel® Turbo Boost Technology.

This feature enables the CPU to run at a higher than normal rate. When all CPU cores are not necessary for the workload, inactive cores are turned off and power is diverted to the active cores to increase their performance.

Turbo Boost is enabled and disabled with the Computer Setup (F10) Utility.

Go to <http://www.hp.com/go/quickspecs> to determine if your CPU supports Turbo Boost.

HP Cool Tools (Windows 7 only)

HP workstations and computers running Windows® 7 include additional software tools. To access or learn more about these tools that can enhance the computer experience:

1. Double-click the **HP Cool Tools** icon on the desktop.
2. To learn more about an HP Cool Tools application, click the **Learn More** link for the application.
3. To install or launch an application, select the and follow the on-screen instructions.

Non-Uniform Memory Access (NUMA)

Non-Uniform Memory Access (NUMA) is available on some Z series Workstations. NUMA can improve memory bandwidth and latency for multi-process or multi-threaded applications or workloads. Observed performance improvements depend on the operating system, customer workload, system configuration, and the degree to which the applications used are designed to be NUMA-aware/efficient.

NUMA requires that both processor sockets be populated. Installed memory should be balanced between both processors for maximum performance.

NUMA is enabled if Memory Node Interleave is disabled in the system BIOS. To do this, press **F10** during startup to enter Computer Setup (F10) Utility. Select **Advanced > Chipset/Memory**. Use the arrow keys to set **Memory Node Interleave** to **Disable**. Press **F10** to exit the menu, then select **File > Save Changes** and **Exit**. NUMA is enabled when the system is restarted.

BIOS ROM

The BIOS ROM is a collection of machine language applications stored as firmware in ROM. It includes functions such as Power on Self Test (POST), PCI device initialization, Plug and Play support, power management, and the Computer Setup (F10) Utility.

Go to <http://www.hp.com/go/quickspecs> to review the latest BIOS ROM specifications.

Computer Setup (F10) Utility

- [Computer Setup \(F10\) functionality](#)
- [Accessing Computer Setup \(F10\) Utility](#)
- [Computer Setup \(F10\) Utility menu](#)

Computer Setup (F10) functionality

The Computer Setup (F10) Utility enables you to:

- Update BIOS using a USB device.
- Change factory default settings and set or change the workstation configuration, which might be necessary when you add or remove hardware.
- Determine if all devices installed on the workstation are recognized by the system and functioning.
- Determine information about the operating environment of the workstation.
- Solve system configuration errors that are detected but not fixed during the Power-On Self-Test (POST).
- Establish and manage passwords and other security features.
- Establish and manage energy-saving time-outs.
- Modify or restore factory default settings.
- Set the workstation date and time.
- Set, view, change, or verify the workstation configuration, including settings for CPU, graphics, memory, audio, storage, communications, and input devices.
- Modify the boot order of installed mass storage devices such as SATA, optical disk drives and network drives.
- Configure the boot priority of SATA hard-drive controllers.
- Enable or disable Network Server Mode, which enables the workstation to start the operating system when the power-on password is enabled with or without a keyboard or mouse attached. When attached to the workstation, the keyboard and mouse remain locked until the power-on password is entered.
- Enable or disable POST Messages to change the display status of POST messages. POST Messages suppresses most POST messages, such as memory count, product name, and other nonerror text messages. If a POST error occurs, the error is displayed regardless of the mode selected. To manually switch to POST Messages Enabled during POST, press any key except **F1** through **F12**.
- Specify an Ownership Tag, which appears when the workstation is powered on or restarted.
- Specify the Asset Tag or property identification number assigned by the company to this workstation.
- Enable power-on password prompts during system restarts (warm-starts) and power on.
- Hide or show the integrated I/O functionality, including serial, USB, or parallel ports, audio, or embedded NIC. Hidden devices are inaccessible, which increases system security.
- Enable or disable removable media boot ability.

- Enable or disable removable media write ability (if supported by hardware).
- Replicate the workstation setup by saving system configuration information on CD and restoring it on workstations.
- Execute self-tests on specified SATA hard disk drives (if supported by the drive).

Accessing Computer Setup (F10) Utility

To access Computer Setup (F10) Utility:

1. Power on or restart the workstation.
2. When the display is active and **Press the ESC key for Startup Menu** appears at the bottom of the screen, press **F10** or **Esc**.

If you do not press **F10** or **Esc** at the appropriate time, try again. Turn the workstation off, then on, and press **F10** again to access the utility. You can also press **Ctrl + Alt + Delete** before starting if you miss the opportunity to press **F10**.

3. Select the language from the list and press the **Enter** key.

In Computer Setup (F10) Utility menu, five headings are displayed: File, Storage, Security, Power, and Advanced.



NOTE: The option for selecting the language is available on first boot only.

4. Use the left and right arrow keys to select the appropriate heading, use the up and down arrow keys to select an option, and then press **Enter**.
5. Choose from the following:
 - To apply and save changes, select **File > Save Changes and Exit**, then press **Enter** to accept the changes.
 - To remove changes you have made, select **Ignore Changes and Exit**, then press **Enter** to acknowledge the cancellation.
 - To reset to factory settings, select **File > Default Setup > Restore Factory Settings as Default**. Press **Enter** to accept the changes, and then select **Apply Defaults and Exit**. This restores the original factory system defaults.



CAUTION: Do not power off the workstation while the ROM is saving Computer Setup (F10) Utility changes, because the Complementary Metal-Oxide Semiconductor (CMOS) nonvolatile storage could become corrupted. After you exit the F10 Setup screen, you can disconnect power from the workstation.

Computer Setup (F10) Utility menu

The following tables describe the functions available in Computer Setup (F10) (BIOS) utility menu.



NOTE: With new BIOS releases, the following content is subject to change, so the menu might be different than shown.

Heading	Option	Description
File	System Information	Displays the following system characteristics: <ul style="list-style-type: none">• Product Name• SKU Number• Processor Type• Processor Speed• Processor Stepping (stepping designation and patch number)• Cache Size (L1/L2/L3)• Memory Size (Channel A, Channel B)• Integrated MAC (onboard NIC)• System BIOS• Chassis Serial Number• Asset Tracking Number• ME (Intel Management Engine) Firmware Version• ME Management Mode• PCIe Speed Slot 1-6—Reports the configured speed of the PCIe cards in the system (not available on HP Z220)
	About	Displays copyright information.
	Set Time and Date	Lets you set system time and date. Use the keyboard Tab and arrow keys to make changes.
	Flash System ROM	Lets you upgrade the BIOS from a ROM image on optical media or USB.
	Replicated Setup	Provides these options: <ul style="list-style-type: none">• Save to Removable Media—Saves the computer configuration, including CMOS, to a USB storage device. The saved configuration file is named <i>cpqsetup.txt</i>.• Restore from Removable Media—Restores the computer configuration from a USB storage device.
	Default Setup	Provides these options: <ul style="list-style-type: none">• Save Current Settings as Default—Saves the current settings as default settings for the next operation.• Restore Factory Settings as Default—Restores the factory settings as the default settings for the next operation.
	Apply Defaults and Exit	Restores the default settings defined in Default Setup.
	Ignore Changes and Exit	Exits computer setup without applying or saving changes.

Heading	Option	Description
	Save Changes and Exit	Saves changes to system configuration and exits the computer setup.
Storage	Device Configuration	Lists installed storage devices and provides specific information about each device: <ul style="list-style-type: none"> • Hard Disk—Provides information about the hard disk drives. • AHCI-HDD/SDD—Use the ACHI mode. • CD-ROM—Provides information about the optical disk drives.
	Storage Options	Provides these options: <ul style="list-style-type: none"> • eSATA Port—Displays the internal SATA port(s) that are configured to operate as eSATA. Changing this to None provisions the port(s) as internal SATA. • SATA Emulation—Sets the SATA emulation mode with the following options: <ul style="list-style-type: none"> ◦ RAID + AHCI—Both the RAID and AHCI OPROMs execute. This emulation mode is the default and offers the best performance and highest functionality. ◦ IDE—Offers standard SATA support. Some higher-numbered SATA ports may not be available in this mode. ◦ AHCI—Only the AHCI OPROM executes. • Removable Media Boot (Enabled/Disabled)—Enabling allows the workstation to boot from removable media, such as a USB flash drive. • Max eSATA Speed—Configures eSATA port speeds: <ul style="list-style-type: none"> ◦ Gen 2 (3.0 Gbps) ◦ Gen 1 (1.5 Gbps)
	DPS Self-test	Select a drive—Lets you execute self-tests on SATA hard drives capable of performing Drive Protection System (DPS) self-tests. NOTE: This selection appears only when the system has one or more drives capable of performing the DPS self-tests.
	Boot Order	Lets you configure the boot order by physically reordering the menu entries. The default boot order is: <ul style="list-style-type: none"> • UEFI Boot Sources <ul style="list-style-type: none"> ◦ USB Floppy/CD ◦ USB Hard Drive ◦ ATAPI CD/DVD Drive • Legacy Boot Sources <ul style="list-style-type: none"> ◦ ATAPI CD/DVD Drive ◦ USB Floppy/CD ◦ Hard Drive ◦ Network Controller <p>You can take the following actions:</p> <ul style="list-style-type: none"> • Press Enter to drag a device with the arrow keys to a preferred place, then press Enter again to drop the device in place. • Press F5 to remove the device from consideration as a bootable device.

Heading	Option	Description
		<ul style="list-style-type: none"> You must confirm changes by selecting File>Save Changes and Exit and then press Enter. The computer then stores boot order changes in the physical ROM. <p>To temporarily override the boot order and boot from a device other than the default device specified in Boot Order:</p> <ol style="list-style-type: none"> Restart the computer. Press F9 when the F9=Boot Menu message appears on the screen. Wait for POST to finish and for the list of bootable devices to display. Use the arrow keys to select the preferred boot device. Press Enter. The computer then starts from the selected nondefault device. (This does not change the default boot device.)
Security	Setup Password	<p>Lets you set and enable a setup password for the administrator.</p> <p>If you create a setup password, you must use it to change computer setup options, to flash the ROM, and to make changes to certain Plug and Play settings under Windows.</p>
	Power-On Password	Let you set and enable the power-on password.
	Password Options	<p>This option becomes available depending on the presence of setup or power-on passwords. It provides these options:</p> <ul style="list-style-type: none"> Lock Legacy Resources (Enabled/Disabled)—Prevents the operating system from changing resources to serial, parallel, or diskette controller. (Appears if a setup password is set.) Setup Browse Mode (Enabled/Disabled)—Lets you view but not change the F10 Setup Options without having to enter the setup password. (Appears if a setup password is set.) Password prompt on F9, F11, and F12 (Enabled/Disabled)—Lets you access menus without entering the setup password. Network Server Mode (Disabled/Enabled)—Enables network server mode. (Appears if a power-on password is set.) Stringent Password (Disabled/Enabled)—Creates a password that cannot be reset by the password jumper.
	Smart Cover	Lets you enable/disable the cover removal sensor ¹ .
	Device Security	<p>Makes the following devices available or hidden to the computer:</p> <ul style="list-style-type: none"> Embedded Security Device (hidden by default) System Audio Network Controller SATA ports <p>With the exception of Embedded Security Device (TPM), Device Available is the default setting for all devices (allows the operating system to access the device). Device Hidden disables the device by the BIOS so that the operating system can no longer enable the device.</p> <p>NOTE: An entry for enabling DriveLock appears in the setup menu if the computer has a DriveLock-compatible hard disk drive.</p>
	USB Security	<p>Set workstation USB ports to Enabled/Disabled (Enabled by default):</p> <ul style="list-style-type: none"> Front USB Ports

Heading	Option	Description
		<ul style="list-style-type: none"> Rear USB Ports Internal USB Ports
	Slot Security	Lets you disable any PCI or PCI Express slot.
	Network Boot	Lets you Enable/Disable the ability to boot from the network using the F12 key or the boot order. (Enable is default.)
	System IDs	<p>Provides these options (CTRL+A to view data):</p> <ul style="list-style-type: none"> Asset Tag—A user-editable, 16-byte string identifying the computer. Ownership Tag—A user-editable, 80-byte string identifying ownership of the computer. This tag appears on the screen during POST. Universal Unique Identifier (UUID)—An ID number set in the factory that uniquely identifies the computer. Keyboard—Lets you set the keyboard locale for System ID entry.
	Master Boot Record (MBR) Security	<p>When MBR Security is enabled, the BIOS prevents any changes being made to the MBR of the current bootable disk while in MS-DOS or Windows Safe Mode—(Enable or Disable).</p> <p>NOTE: Most operating systems control access to the MBR of the current bootable disk; the BIOS cannot prevent changes that may occur while the operating system is running.</p>
	System Security	<p>With the exception of the first option, Data Execution Prevention, changing any of these system security settings and choosing File > Save Changes and Exit will result in the computer performing a global reset, automatically turning itself off and then back on. Note also that these options are hardware dependent and may not be available on some models:</p> <ul style="list-style-type: none"> Data Execution Prevention (Enabled/Disabled)—Helps prevent operating system security breaches. Virtualization Technology (VTx)¹ (Disabled/Enabled)—Controls the virtualization features of the processor. Virtualization Technology Directed I/O (VTd)¹ (Disabled/Enabled)—Controls virtualization DMA remapping features of the chipset. Intel TXT(LT) Support¹ (Enabled/Disabled)—Controls the underlying processor and chipset features needed to support a virtual appliance. To enable this feature you must enable: <ul style="list-style-type: none"> Virtualization Technology (VTx) Virtualization Technology Directed I/O (VTd) Embedded Security Device Embedded Security Device¹ (Disabled/Enabled)—Permits activation and deactivation of the Embedded Security Device. <p>NOTE: Embedded Security Device must be set to Device Available in the Device Security menu, and you must create a Setup Password, in order to configure the Embedded Security Device.</p> <ul style="list-style-type: none"> Measure boot variables/devices to PCR1 (Disabled/Enabled)—Logs the measurements of the boot variables/devices to PCR1 instead of PCR5 Reset to Factory Settings¹ (Do not reset/Reset)—Restores factory defaults and erases all security keys.

Heading	Option	Description
		<p>CAUTION: Choosing Reset to Factory Settings may result in significant data loss. The embedded security device is a critical component of many security schemes. Erasing the security keys prevent access to data protected by the Embedded Security Device.</p> <ul style="list-style-type: none"> OS Management of Embedded Security Device¹ (Disabled/Enabled)—Limits operating system control of the Embedded Security Device. Reset of Embedded Security Device through OS¹ (Enabled/Disabled)—Limits the operating system ability to request a Reset to Factory Settings of the Embedded Security Device. <p>NOTE: You must create a Setup Password to use this option.</p> <ul style="list-style-type: none"> No PPI provisioning (Disabled/Enabled)—Allows the operating system to provision the TPM without a Physical Presence Interface (PPI). Allow PPI policy to be changed by OS (Disabled/Enabled)—Allows the operating system to change TPM PPI policies. Trusted Execution Technology (Disabled/Enabled)—Turns Intel TXT on or off (HP Z220). Intel TXT (LT) Support (Disabled/Enabled)—Turns Intel TXT(LT) on or off (HP Z420, HP Z620, HP Z820).
	Drive Lock Security	<p>Lets you assign or modify a master password or user password for hard drives. When enabled, this feature prompts the user to provide one of the DriveLock passwords during POST. If the user does not successfully enter one of the passwords, the hard drive remains inaccessible until one of the passwords is successfully entered during a subsequent cold-boot sequence.</p> <p>NOTE: This selection appears only when the system includes at least one drive that supports the DriveLock feature.</p>
	Secure Boot Configuration	<ul style="list-style-type: none"> Legacy Support—Enable/Disable Secure Boot—Enable/Disable All option ROMs must support EFI. Key Management <ul style="list-style-type: none"> Clear Secure Boot Keys—Clear/Don't Clear Key Ownership—HP Keys/Custom Keys Fast Boot—Enable/Disable
Power	OS Power Management	<p>Enables or disables:</p> <ul style="list-style-type: none"> Runtime Power Management Idle Power Savings: Extended (default) or Normal; extended mode reduces processor power consumption when the CPU is idle ACPI S3 PS2 Mouse Wakeup Unique Sleep State Blink Rates Turbo Mode (Enabled/Disabled)—Allows Intel processors to SpeedStep. See Device Options for the HP Z220. PCIe Performance Mode (Disabled/Enabled)—Changing PCIe Performance might change Runtime Power Management, Turbo Mode, and/or Idle Power Savings settings. Not available on HP Z220.
	Hardware Power Management	<p>Enables or disables:</p> <ul style="list-style-type: none"> SATA Power Management S5 Maximum Power Savings

Heading	Option	Description
	Thermal	Lets you set the minimum speed of the system fan when the CPU is idle.
Advanced ²	Power-On Options	<p>Sets the following:</p> <ul style="list-style-type: none"> • POST Messages (Enabled/Disabled) • Press the ESC key for Startup Menu (Enabled/Disabled) • Option ROM Prompt (Enabled/Disabled)—Enabling this feature causes the computer to display a message before loading option ROMs. • After Power Loss—Lets you specify computer behavior after a power loss: <ul style="list-style-type: none"> ◦ Power Off—Computer remains powered off when power is restored (default). ◦ Power On—Computer automatically powers on when power is restored. (This lets you power on the computer using a power strip switch, if the computer is connected to an electric power strip.) ◦ Previous state—Computer powers on automatically when power is restored only if computer was on when power was lost. <p>NOTE: If you turn off power to the computer using a power strip, you cannot use the suspend/sleep feature or the Remote Management features.</p> • POST Delay (None (default), 5, 10, 15, 20 seconds)—Delays start of the POST process. You might need a delay to: <ul style="list-style-type: none"> ◦ Allow time for some hard disk drives to spin up before POST is finished. ◦ Give yourself more time to select F10 to enter Computer Setup (F10) Utility. • Remote Wakeup Boot Source (Local Hard Drive/Remote Server). Sets the boot device for the workstation when it is started using Remote Wakeup (takes precedence over the Boot Order menu setting). • Bypass F1 Prompt on Confirmation Changes (Enabled/Disabled)—Prevents display of a confirmation prompt when you make changes to the system. • Mini Option ROM Display (Enabled/Disabled)—Displays the mini option ROM windows during POST. Not available on HP Z220. • Factory Recovery Boot Support (Enabled/Disabled) • POST Memory Manager Runtime Allocation (Disabled/Enabled)—Forces legacy POST Memory Manager (PMM) to use runtime memory for allocation. This prevents Hibernation issues with some EFI Windows installations (HP Z220).
	BIOS Power-On	Lets you disable or specify a weekday and time for BIOS power-on.
	Onboard Devices	Lets you disable or set resources (IRQ, DMA, I/O Range) for onboard system devices such as the serial port and parallel ports. Operating system parameters generally override Onboard Devices settings.
	Bus options	<p>Enable/disable these options:</p> <ul style="list-style-type: none"> • PCI SERR# Generation (Enabled/Disabled)—Controls PCI SERR# generation for ill-behaved PCI add-in cards (that can generate SERR# spuriously). • PCI VGA Palette Snooping (Disabled/Enabled)—Controls PCI VGA Palette Snooping for compatibility purposes. • PCI Latency Timer (32/64/96/128/160/192/224/248). 128 PCI Clocks is the default.

Heading	Option	Description
		<ul style="list-style-type: none"> Legacy ACPI CPU Tables (Disabled/Enabled)—Reports CPUs in the ACPI 1.0 format. Not available on HP Z220.
	Device Options	<p>Enable/disable the following device options:</p> <ul style="list-style-type: none"> Turbo Mode (Enabled/Disabled)—Allows Intel processors to run at frequencies greater than the maximum (HP Z220). S5 Wake-on-LAN (Enabled/Disabled)—Allows unit to be powered on over the network. Printer Mode (EPP+ECP, Output Only, Bi-Directional) Num Lock State at Power-On (On/Off) Integrated Video¹ (Enabled/Disabled) IGD (Integrated Graphics Device) Memory—Displayed when Integrated Video is Enabled. Sets the maximum amount of system memory that can be allocated as graphics memory (32, 128 (default), 256, 512 MB). Not available on HP Z420, HP Z620, or HP Z820.¹ Internal Speaker (Enabled/Disabled) NIC/PXE Option ROM² Download (PXE/Disabled) SATA RAID Option ROM² Download (Enabled/EFI/Disabled) Multi-Processor (Enabled/Disabled) Hyperthreading¹ (Disabled/Enabled) PXE Option ROMS (Legacy, UEFI Only, Do Not Launch)—Available on HP Z220 under Option ROM Launch Policy. Mass Storage Option ROMS (Legacy, UEFI Only, Do Not Launch)—Available on HP Z220 under Option ROM Launch Policy. Video Option ROMS (Legacy, UEFI Only)—Available on HP Z220 under Option ROM Launch Policy.
	Slot Settings	<p>Lets you Enable/Disable Option ROM Download for each slot. Selective disabling of Option ROM downloads can help manage limited Option ROM space. Limit PCIe Frequency to Gen1, Gen2, Gen3. Runs slot at Gen1, Gen2, or Gen3 frequency.</p> <ul style="list-style-type: none"> Slot Option ROM Download (Enabled/Disabled) <ul style="list-style-type: none"> Limit PCIe Speed (Auto, 2.5 GB Gen1, 5 GB Gen2)—Not available on HP Z220.
	Management Operations	<p>Lets you set the following AMT (Intel Active Management Technology) configuration options:</p> <ul style="list-style-type: none"> AMT (Enabled/Disabled)—Allows for remote discovery, repair and protection of networked workstations. Enabling the AMT function also enables the Network Controller (required for AMT to function correctly). Unconfigure AMT/ME (Disabled/Enabled)²—Restores AMT/ME defaults. When you save and exit after enabling this option, you will be prompted to complete the process upon restart. A Setup Password (even if one is set) does not need to be entered to complete the process. <p>NOTE: Information about Intel AMT can be found at www.intel.com.</p> <ul style="list-style-type: none"> Hide Un-configure ME Confirmation Prompt (Disabled/Enabled) WatchDog Timer (Enabled/Disabled)—OS and BIOS WatchDog Timers can be set independently (in minutes):

Heading	Option	Description
		<ul style="list-style-type: none"> ◦ OS WatchDog Timer—Sets the OS WatchDog Timer. ◦ BIOS WatchDog Timer—Sets the BIOS WatchDog Timer.
	Option ROM Launch Policy	<p>The Option ROM Launch Policy is not available on the HP Z420, HP Z620, or HP Z820. The equivalent settings for those workstations can be found under Device Options.</p> <ul style="list-style-type: none"> • PXE Option ROMs—(Legacy, UEFI Only, Do Not Launch) • StorageOption ROMs—(Legacy, UEFI Only, Do Not Launch) • Video Option ROMs—(Legacy, UEFI Only)

¹ *Available on selected models.

² *These options should be used by advanced users only.

Heading	Option	Description
File	System Information	<p>Displays the following system characteristics:</p> <ul style="list-style-type: none"> • Product Name • Memory Size • SKU Number • Integrated MAC 1 • Integrated MAC 2 (select models only) • System BIOS • Boot Block Date • Chassis serial number • Asset Tracking Number • ME Firmware Version • ME Management Mode • Processor Type • Processor Speed • Processor Stepping • Cache Size • DIMMs
	About	Displays copyright information.
	Set Time and Date	Enables you to set system time and date.
	Flash System ROM	Enables you to upgrade the BIOS from a ROM image on diskette, CD, or USB.
	Replicated Setup	<p>Provides these options:</p> <ul style="list-style-type: none"> • Save to Removable Storage Device—Saves the workstation configuration, including CMOS, in the qsetup.txt file. This file can be saved to a USB device or other storage media.

Heading	Option	Description
		<ul style="list-style-type: none"> Restore from Removable Storage Device—Restores the workstation configuration from a USB device or other storage media.
	Default Setup	<p>Provides these options:</p> <ul style="list-style-type: none"> Save Current Settings as Default—Saves the current settings as default settings for the next operation. Restore Factory Settings as Default—Restores the factory settings as the default settings for the next operation.
	Apply Defaults and Exit	Restores the default settings defined in Default Setup.
	Ignore Changes and Exit	Exits workstation setup without applying or saving changes.
	Save Changes and Exit	Saves changes to system configuration and exits the workstation setup.
Storage	Device Configuration	<p>Lists installed non-SCSI storage devices (except SATA devices) and provides options for obtaining specific information about each device:</p> <ul style="list-style-type: none"> CD-ROM SATA0—Shows the ODD default settings. Default Values (SATA defaults)— <ul style="list-style-type: none"> Translation Mode—Enables the BIOS to determine the translation mode used to configure a formatted SATA or USB mass storage device. This prevents you from needing to know how the mass storage device was formatted. Options are Automatic, Bit Shift, LBA Assisted, User (Cylinders, Heads, Sectors), and Off. Automatic is the default. <p>Ordinarily, you should not change the translation mode selected by the BIOS. If the selected translation mode is not compatible with the translation mode that was active when the drive was partitioned and formatted, the data on the disk is inaccessible.</p>
	Storage Options	<p>Provides these options:</p> <ul style="list-style-type: none"> Removable Media Boot—Enables and disables the ability to start the workstation from removable media. SATA Mode—Sets the SATA emulation mode with the following options: <ul style="list-style-type: none"> RAID + AHCI—The controller operates in AHCI emulation mode, which supports AHCI protocol and executes RAID OPROMs. This emulation mode is the default and offers the best performance and most functionality. AHCI—The controller operates in AHCI emulation mode, which supports AHCI protocol. IDE—Offers standard SATA supports (four ports only). Serial-ATA Controller—Enhanced, Compatible, or Disabled. The default is Enhanced. This option is only available when in IDE-mode.
	Boot Order	<p>Enables you to configure the boot, diskette drive, and hard disk drive orders by physically reordering the menu entries. The following is the default boot order presented in the menu:</p> <ul style="list-style-type: none"> EFI Boot Sources <ul style="list-style-type: none"> USB Floppy/CD USB Hard Drive ATAPI CD/DVD Drive

Heading	Option	Description
		<ul style="list-style-type: none"> • Legacy Boot Service <ul style="list-style-type: none"> ◦ ATAPI CD/DVD Drive ◦ USB Floppy/CD ◦ Hard Drive ◦ Network Controller <p>Press Enter to drag a device to a preferred place. Press F5 to remove the device from consideration as a bootable device. Press F10 to accept.</p> <p>MS-DOS drive lettering assignments might not apply after an operating system other than MS-DOS has started.</p> <p>Boot devices can be disabled in the boot order process. These order changes are stored in the physical ROM when the F10 Setup changes are confirmed with File>Save Changes and Exit.</p> <p>You can temporarily override the boot order. To start one time from a device other than the default device specified in Boot Order, restart the workstation and press F9 when the F9=Boot Menu message appears on the screen. After POST completes, a list of bootable devices is displayed. Use the arrow keys to select the preferred bootable device and press Enter. The workstation then starts from the selected nondefault device for this one time.</p>
	DPS Self-test	<p>Select a drive—Lets you execute self-tests on SATA hard drives capable of performing Drive Protection System (DPS) self-tests.</p> <p>NOTE: This selection appears only when the system has one or more drives capable of performing the DPS self-tests.</p>
Security	Setup Password	<p>Enables you to set and enable a setup password for the administrator.</p> <p>If you create a setup password, you must use it to change workstation setup options, to flash the ROM, and to make changes to certain Plug and Play settings under Windows.</p>
	Power-On Password	<p>Enables you to set and enable the power-on password.</p>
	Password Options	<p>This option becomes available when you create a setup and/or power-on password. It provides these options:</p> <ul style="list-style-type: none"> • Lock Legacy Resources—Prevents the operating system from changing resources to serial, parallel, or diskette controller. • Setup Browse Mode—Enables read-only functionality for password info. • Password Prompt on F9 & F12—Enables a password prompt on a warm boot. • Network Server Mode—Enables network server mode.
	Device Security	<p>Makes the following devices available or hidden to the workstation:</p> <ul style="list-style-type: none"> • Embedded Security Device • SAS Controller (select models only) • SCU Controller (select models only) • USB3 Controller • Intel High Definition (HD) Audio (select models only) • 1394 Controller • NIC Controller • NIC1 Controller (select models)

Heading	Option	Description
		<ul style="list-style-type: none"> • SATA0 • SATA1 • Serial Port A <p>For each device, Device Available is the default setting and allows the operating system to access the device. Device Hidden makes the device unavailable; it is disabled by the BIOS and cannot be enabled by the operating system.</p> <p>NOTE: An entry for enabling DriveLock appears in the setup menu if the workstation has a DriveLock-compatible hard disk drive.</p>
	USB Security	<p>Set workstation USB ports to Enabled/Disabled:</p> <ul style="list-style-type: none"> • Front USB Ports—(1–3) • Rear USB Ports—(1–6) • Internal USB Ports—(1–6)
	Slot Security	Lets you enable or disable any PCI or PCI Express slot.
	Network Boot	Enables or disables the ability to boot to the network using the F12 key or the boot order.
	System IDs	<p>Provides these options:</p> <ul style="list-style-type: none"> • Asset Tag—A 16-byte string identifying the workstation. • Ownership Tag—An 80-byte string identifying ownership of the workstation. This tag appears on the screen during POST. • Universal Unique Identifier (UUID)—Can only be updated if the current chassis serial number is invalid. (These ID numbers are normally set in the factory and are used to uniquely identify the workstation.) • Keyboard—Enables you to set the keyboard locale for System ID entry.
	Master Boot Record Security (MBR)	<p>Enable or Disable—When MBR Security is enabled, the BIOS prevents any changes being made to the MBR of the current bootable disk while in MS-DOS or Windows Safe Mode.</p> <p>Most operating systems control access to the MBR of the current bootable disk; the BIOS cannot prevent changes that may occur while the operating system is running.</p>
	System Security	<p>Provides these options:</p> <ul style="list-style-type: none"> • Data Execution Prevention—Enables or disables Data Execution Prevention mode in the CPUs. This mode prohibits code from running in pages that were set up as data pages, and prevents attacks such as buffer overflows. Operating system support is required for this feature. • Virtualization Technology (VTx)—Enables or disables Intel® Virtualization Technology to increase workstation performance. • Intel® (VTd)—(Enabled or Disabled) Controls the underlying processor and chipset features needed to support a virtual appliance. • Interrupt Remapping—Enables or disables—Only available when Intel®(VTx) is enabled. • Coherency Support—Enables or disables—Only available when Intel® (VTx) is enabled. • ATS Support—Enables or disables—Only available when Intel® (VTx) is enabled. • Pass-through DMA—Enables or disables—Only available when Intel(R) (VTx) is enabled.

Heading	Option	Description
		<ul style="list-style-type: none"> • Embedded Security Device—This option becomes available if Embedded Device is set to Available under Device Security. <p>NOTE: Embedded Security Device must be set to Device Available in the Device Security menu, and you must create a Setup Password, in order to configure the Embedded Security Device.</p> <p>Embedded Security Device (Hidden or Available) turns the Trusted Platform Mechanism (TPM) on and off. Device Hidden is the default. If this option is made available, the following options become available:</p> <ul style="list-style-type: none"> ◦ Power-On Authentication Support—Enables and disables an authentication feature that requires you to enter a TPM user key password to start the workstation. This feature uses the TPM to generate and store the authentication password. ◦ Reset Authentication Credential—Resets the authentication functionality and clears authentication credentials. <p>To enable the Embedded Security Device and to access any security features associated with the device, you must enter a setup password.</p> <p>Setting a device to Available enables the operating system to access the device. Hidden makes the device unavailable. It is disabled by the BIOS and cannot be enabled by the operating system.</p> <p>CAUTION: Choosing Reset to Factory Settings may result in significant data loss. The embedded security device is a critical component of many security schemes. Erasing the security keys prevent access to data protected by the Embedded Security Device.</p> • OS Management of Embedded Security Device—Enables or disables the ability of the operating system to control the TPM device, including turning it on and off, initializing it, and resetting it. <ul style="list-style-type: none"> ◦ Reset of Embedded Security Device through OS—Enables or disables the ability of the operating system to reset the TPM. Available only when OS Management of Embedded Security Device is enabled.
	DriveLock Security	<p>Lets you assign or modify a master password or user password for hard drives. When enabled, this feature prompts the user to provide one of the DriveLock passwords during POST. If the user does not successfully enter one of the passwords, the hard drive remains inaccessible until one of the passwords is successfully entered during a subsequent cold-boot sequence.</p> <p>NOTE: This selection appears only when the system includes at least one drive that supports the DriveLock feature.</p>
	Secure Boot Configuration	<ul style="list-style-type: none"> • Legacy Support—Enable/Disable • Secure Boot—Enable/Disable • Key Management <ul style="list-style-type: none"> ◦ Clear Secure Boot Keys—Clear/Don't Clear ◦ Key Ownership—HP Keys/Custom Keys • Fast Boot—Enable/Disable
Power	OS Power Management	<p>Enables or disables:</p> <ul style="list-style-type: none"> • Runtime Power Management—(Enable or Disable) • Turbo Mode—(Enable or Disable) • Idle Power Savings—Extended (default) or Normal; extended mode reduces processor power consumption when the CPU is idle.

Heading	Option	Description
		<ul style="list-style-type: none"> • Unique Sleep State Blink Rates—(Enable or Disable)
	Hardware Power Management	<p>Enables or disables:</p> <ul style="list-style-type: none"> • SATA Power Management • S5 Maximum Power Savings
	Thermal	Enables you to set the rate of the system fan when the CPU is in idle (Fan Idle Mode).
Advanced ²	Power-On Options	<p>Enables you to set the following:</p> <ul style="list-style-type: none"> • POST Messages—Enables or disables the splash screen during POST. • Press the ESC key for Startup Menu. • Option ROM¹ prompt (Enable or Disable)—Enabling this feature causes the workstation to display a message before loading options ROMs. • After Power Loss (On, Off, Last State)—Enabling this option directs the previous state to be the default. • POST Delay (in seconds) (5, 10, 15, 20, None)—Adds a specified delay to the POST process. This delay is sometimes needed for hard disk drives on some expansion cards that spin up slowly (so slowly that they are not ready to start by the time POST is finished). The POST delay also gives you time to select F10 to enter Computer Setup (F10) Utility. • Remote Wakeup Boot Source—Enables you to set the remote wakeup boot source as: <ul style="list-style-type: none"> ◦ Local Hard Drive ◦ Remote Server • Bypass F1 Prompt on Configuration Changes.
	BIOS Power-On	Enables you to disable or specify a weekday and time for BIOS power-on.
	Onboard Devices	Enables you to set resources (IRQ, DMA, I/O Rate) for or disable onboard system devices such as serial port and diskette controller. Operating system parameters generally override Onboard Devices settings.
	Bus Options	<p>Configures graphics cards per workstation slots. In multi-graphics card configurations, this option designates one card as primary graphics, and the other card as secondary graphics.</p> <ul style="list-style-type: none"> • Numa—(Enable or Disable) • SERR# Generation (Enabled/Disabled)—Controls PCI SERR# generation for ill-behaved PCI add-in cards (that can generate SERR# spuriously) • VGA Palette Snoop (Disabled/Enabled)—Controls PCI VGA Palette Snooping for compatibility purposes • PCI Latency Timer—(32/64/128/160/192/224/248). 128 PCI Clocks is the default.
	Device Options	<p>Enables you to set the following device options:</p> <ul style="list-style-type: none"> • Num Lock State at Power-On (On or Off) • S5 Wake-on-LAN (Enable or Disable) • Internal speaker—(Enable or Disable) • NIC Option ROM¹ Download (Enable or Disable) • NIC1 Option ROM¹ Download (Enable or Disable) • Mass Storage Option ROMS (Legacy/EFI)

Heading	Option	Description
		<ul style="list-style-type: none"> • SAS Option ROM¹ Download (Enable/Disable) (Not available on HP Z220.) • SCU Option ROM Download (Enable/EFI/Disable) (Not available on HP Z220.) • Multiprocessor (Activates a single core.)—(Enable or Disable) • Active Processor Cores—Selects a single core, or multiple cores per socket • Hyper-Threading—(Enable or Disable) • CECF Mode—(Enable or Disable) • Thunderbolt (Legacy, Unique ID, One time saved key, DP++ only)—In Legacy mode, all devices are allowed to connect without user intervention. In the default Unique ID mode, device connection is managed by the Thunderbolt service running on the host system. One time saved key mode allows the Thunderbolt host controller to differentiate between multiple devices of the same type connected to Falcon Ridge devices. DP++ only mode allows monitor-only connections, so there is no data traffic. Not available on HP Z220.
	Slot Settings	Enable/disable the PCIe and PCI slots (1 - 7).
	AMT Configuration	<p>Lets you set the following AMT (Intel Active Management Technology) configuration options:</p> <ul style="list-style-type: none"> • AMT (Enabled/Disabled)—Allows for remote discovery, repair and protection of networked workstations. Enabling the AMT function also enables the Network Controller (required for AMT to function correctly). • Unconfigure AMT/ME (Disabled/Enabled) ²—Restores AMT/ME defaults. When you save and exit after enabling this option, you will be prompted to complete the process upon restart. A Setup Password (even if one is set) does not need to be entered to complete the process. <p>NOTE: Information about Intel AMT can be found at http://www.intel.com.</p> <ul style="list-style-type: none"> • WatchDog Timer (Enabled/Disabled)—OS and BIOS WatchDog Timers can be set independently (in minutes): <ul style="list-style-type: none"> ◦ OS WatchDog Timer—Sets the OS WatchDog Timer ◦ BIOS WatchDog Timer—Sets the BIOS WatchDog Timer

¹ Available on selected models

² These options should be used by advanced users only

Desktop management

This section summarizes capabilities, features, and key components of computer management.

- [Initial computer configuration and deployment](#)
- [Installing a remote system](#)
- [Copying a setup configuration to another computer](#)
- [Updating and managing software](#)
- [HP Client Management Solutions](#)
- [Altiris Client Management Solutions](#)
- [HP SoftPaq Download Manager](#)
- [System Software Manager](#)
- [ROM Flash](#)
- [FailSafe Boot Block](#)
- [Workstation security](#)
- [Fault notification and recovery](#)
- [Programmable power button \(Windows only\)](#)



NOTE: Support for specific features described in this guide can vary by model and software version.

Initial computer configuration and deployment

The computer includes a preinstalled system software image. After a brief software unbundling process, the computer is ready to use.

If you prefer to replace the preinstalled software image with a customized set of system and application software, you can deploy a customized software image by:

- Installing additional software applications after unbundling the preinstalled software image
- Using a disk cloning process to copy the contents from one hard disk drive to another

The HDD-based HP Recovery Manager ROM-based setup, and ACPI hardware provide further assistance with recovery of system software, configuration management and troubleshooting, and power management.

Support for specific features described in this guide can vary by model and software version.

The best deployment method depends on the information technology environment and processes.

Installing a remote system

Remote system installation enables starting and setting up the computer using software and configuration information on a network server. This feature is usually used for system setup and configuration and can be used to:

- Deploy a software image on new PCs
- Format a hard disk drive
- Install application software or drivers
- Update the operating system, application software, or drivers

To initiate a remote system installation, press **F12** when **F12=Network Service Boot** appears in the lower right corner of the HP logo screen. Follow the onscreen instructions to continue the installation process. The default boot order is a BIOS configuration setting that can be changed to always attempt a network boot.

Copying a setup configuration to another computer

This section provides information about replicating the computer setup.

 **CAUTION:** Setup configuration is model-specific. File system corruption can result if source and target computers are not the same model.

To copy a setup configuration:

1. Select a setup configuration to copy, and then restart the computer.
2. As soon as the computer powers on, press and hold **F10** until you enter Computer Setup (F10) Utility. If necessary, press **Enter** to bypass the title screen.

 **NOTE:** If you do not press **F10** at the appropriate time, you must restart the computer, and then press and hold **F10** again to access the utility.

If you are using a PS/2 keyboard, you might see a keyboard error message. Disregard it.

3. Select **File > Replicated Setup > Save to Removable Storage Device**. Follow the instructions on the screen to create the configuration file *cpqsetup.txt* and write it to a USB storage device.
4. Turn off the computer you are configuring and insert the removable USB media device containing the configuration file.
5. Turn on the computer you are configuring.
6. Press and hold the **F10** key until you enter Computer Setup (F10) Utility. If necessary, press **Enter** to bypass the title screen.
7. Select **File > Replicated Setup > Restore from Removable Storage Device**, and then follow the instructions on the screen.
8. Restart the computer when the configuration is complete.

Updating and managing software

HP provides several tools for managing and updating software on desktops and computers:

- HP Client Manager Software
- Altiris Client Management Solutions
- HP SoftPaq Download Manager
- System Software Manager

HP Client Management Solutions

HP Client Management Solutions (CMS), available for download from <http://www.hp.com/go/easydeploy>, are standards-based solutions for managing and controlling computers in a networked environment.

HP Client Management Solutions offers these services:

- Detailed views of hardware inventory for asset management
- PC health-check monitoring and diagnostics
- Proactive notification of changes in the hardware environment
- Web-accessible reporting of business-critical details such as thermal warnings and memory alerts
- Remote updating of system software such as device drivers and ROM BIOS
- Remote changing of boot order
- Configuration of system BIOS settings

Altiris Client Management Solutions

Altiris and HP have partnered to provide comprehensive, tightly integrated systems management solutions to reduce the cost of owning HP client PCs.

The HP CMS is the foundation for additional Altiris Client Management Solutions that address the following topics.

- Inventory and asset management
- Deployment and migration
- Help desk and problem resolution
- Software and operations management

Go to http://www.hp.com/go/Altiris_Solutions for information about:

- How HP CMS works
- Which solutions are compatible with the operating system
- How to download a fully functional, 30-day evaluation version of Altiris solutions

HP SoftPaq Download Manager

HP SoftPaq Download Manager is a free, easy-to-use interface for locating and downloading software updates for the HP client PC models in your environment. By specifying your models, operating

system, and language, you can quickly locate, sort, and select the softpaqs you need. For more information, go to <http://www.hp.com/go/sdm>.

System Software Manager

System Software Manager (SSM) is a utility available on Windows—based computers that enables you to update system-level software on multiple systems simultaneously. When executed on a PC client system, SSM detects hardware and software versions and then updates the software from a central repository, known as a *file store*. Driver versions supported by SSM are noted with a special icon on the software, the driver download website, and on the Support Software CD.

To download the utility or to obtain more information about SSM, see <http://www.hp.com/go/ssm>.

ROM Flash

BIOS settings are stored on a programmable flash ROM. By establishing a setup password in Computer Setup (F10) Utility, you can protect unauthorized users from modifying the BIOS settings. This function is important to ensure the operating integrity of the computer.

To upgrade the BIOS, download the latest SoftPaq images from http://www.hp.com/support/workstation_swdrivers.

Remote ROM Flash

Remote ROM Flash allows system administrators to safely upgrade the ROM on remote HP computers from a centralized network management console, resulting in a consistent deployment of, and greater control over, HP PC ROM images over the network.

To use Remote ROM Flash, the computer must be powered on, or turned on using Remote Wakeup.

For more information about Remote ROM Flash and HPQFlash, see the HP Client Manager Software or System Software Manager sections at <http://www.hp.com/go/ssm>.

HPQFlash

The HPQFlash utility is used to locally update or restore the system ROM on PCs using a Windows operating system. For more information about HPQFlash, see <http://www.hp.com/go/ssm>, and enter the name of the computer.

FailSafe Boot Block

The FailSafe Boot Block enables BIOS recovery in the unlikely event of a ROM flash failure. For example, if a power failure occurs during a ROM upgrade, the Boot Block uses a flash-protected section of the ROM to verify a valid system ROM flash when power is restored to the computer.

If the system ROM is valid, the computer starts normally.

If the system ROM fails the validation check, the FailSafe Boot Block provides enough support to start the computer from a BIOS image CD created from a SoftPaq. The BIOS image CD programs the system ROM with a valid image.

When Boot Block detects an invalid system ROM, the computer power LED blinks red eight times and the computer beeps eight times; then the computer pauses for two seconds. On some models, a Boot Block recovery mode message appears.

In preparation for system recovery, use the BIOS CD media file in the SoftPaq to create a BIOS image CD or USB key.

Recovering the computer from Boot Block Recovery mode

To recover the computer after it enters Boot Block recovery mode:

1. Remove any media such as USB keys or disks in the optical disk drives.
2. Insert a BIOS image CD into the DVD drive. You can also use USB media such as an HP DriveKey.
3. Power off, then power on the computer.

If no BIOS image CD or USB media is found, you are prompted to insert one and restart the computer.

If a setup password has been established, the Caps Lock light illuminates and you are prompted for the password.

4. Enter the setup password.

If the computer starts from the boot media and successfully reprograms the ROM, three keyboard lights illuminate and a rising-tone series of beeps signals successful recovery.

5. Remove the boot media and power off the computer.
6. Restart the computer.

Workstation security

This section provides information about providing system security through asset tracking, password security, hard disk drive locking, and chassis locks.

Asset tracking

Asset tracking features provide asset tracking data that can be managed using HP Systems Insight Manager (HP SIM), HP Console Management Controller (CMC), or other systems-management applications.

Seamless, automatic integration between asset tracking features and these products enables you to choose the management tool that is best suited to the environment and to leverage investments in existing tools.

HP also offers several solutions for controlling access to valuable components and information:

- HP ProtectTools Embedded Security prevents unauthorized access to data, checks system integrity, and authenticates third-party users attempting system access.
- Security features such as ProtectTools and the Smart Cover Sensor (side access panel sensor) help prevent unauthorized access to the data and to the internal components of the computer.
- By disabling parallel, serial, or USB ports, or by disabling removable-media boot capability, you can protect valuable data assets.
- Memory Change and Side access panel sensor (Smart Cover Sensor) alerts can be forwarded to system management applications to deliver proactive notification of tampering with a computer's internal components.

ProtectTools, the Smart Cover Sensor, and the side access panel solenoid lock (Hood Lock) are available as options on select systems.

You can manage security settings:

- Locally with Computer Setup (F10) Utility
- Remotely with HP CMS or HP System Software Manager (SSM), which enable the secure, consistent deployment and control of security settings from a simple command line utility

For more information about Computer Setup (F10) Utility, see [Computer Setup \(F10\) Utility menu on page 43](#).

The following Computer Setup (F10) Utility features let you manage computer security.

Feature	Purpose
Removable Media Boot Control	Prevents booting from removable media drives
Serial, Parallel, USB, or Infrared Interface Control	Prevents transfer of data through the integrated serial, parallel, USB, or infrared interface
Power-On Password	Prevents use of the computer until the password is entered (applies to initial system startup and restarts)
Setup Password	Prevents reconfiguration of the computer (through the Setup utility) until the password is entered
Network Server Mode	Provides unique security features for computers used as servers

SATA hard disk drive security

HP computers include the HP DriveLock facility for SATA hard disk drives to prevent unauthorized access to data.

 **WARNING!** Enabling DriveLock can render a SATA hard disk drive permanently inaccessible if the master password is lost or forgotten. No method exists to recover the password or access the data.

DriveLock has been implemented as an extension to Computer Setup (F10) functions. It is only available when hard disk drives that support the ATA security command set are detected. On HP computers, it is not available when the SATA emulation mode is RAID+AHCI or RAID.

DriveLock is for HP customers for whom data security is a paramount concern. For such customers, the cost of a hard disk drive and the loss of the data stored on it is inconsequential when compared to the damage that could result from unauthorized access to its contents.

To balance this level of security with the need to address the issue of a forgotten password, the HP implementation of DriveLock employs a two-password security scheme. One password is intended to be set and used by a system administrator, while the other is typically set and used by the user.

No "back door" can be used to unlock the drive if both passwords are lost. Therefore, DriveLock is most safely used when the data contained on the hard disk drive is replicated on a corporate information system or is regularly backed up.

If both DriveLock passwords are lost, the hard disk drive is rendered unusable. For users who do not fit the previously defined customer profile, this might not be acceptable. For users who fit this profile, it might be a tolerable risk, given the nature of the data stored on the hard disk drive.

DriveLock applications

The most practical use of DriveLock is in a corporate environment. The system administrator would be responsible for configuring the hard disk drive, which involves setting the DriveLock master password and a temporary user password. If you forget the user password or if the equipment is passed on to another employee, the master password can be used to reset the user password and regain access to the hard disk drive.

HP recommends that corporate system administrators who enable DriveLock also establish a corporate policy for setting and maintaining master passwords. This should be done to prevent a situation where an employee sets both DriveLock passwords before leaving the company. In such a scenario, the hard disk drive is unusable and requires replacement. Likewise, by not setting a master password, system administrators might find themselves locked out of a hard disk drive and unable to perform routine checks for unauthorized software, other asset control functions, and support.

For users with less stringent security requirements, HP does not recommend enabling DriveLock. Users in this category include personal users, or users who do not maintain sensitive data on their hard disk drives as a common practice. For these users, the potential loss of a hard disk drive resulting from forgetting both passwords is much greater than the value of the data DriveLock protects.

Access to Computer Setup (F10) and DriveLock can be restricted through the setup password. By specifying a setup password and not giving it to users, system administrators can restrict users from enabling DriveLock.

Using DriveLock

When hard disk drives that support the ATA security command set are detected, DriveLock appears under the Security menu in Computer Setup (F10) menu. You are presented with options to set the master password and to enable DriveLock. You must provide a user password to enable DriveLock. Because the initial configuration of DriveLock is typically performed by a system administrator, a master password should be set first.

HP encourages system administrators to set a master password whether they plan to enable DriveLock or not. This gives the administrator the ability to modify DriveLock settings if the drive is locked in the future. After the master password is set, the system administrator can enable DriveLock or leave it disabled.

If a locked hard disk drive is present, POST requires a password to unlock the device. If a power-on password is set and it matches the device's user password, POST does not prompt the user to re-enter the password. Otherwise, the user is prompted to enter a DriveLock password.

For a cold start, use the master or user password. For a warm start, enter the same password used to unlock the drive during the preceding cold start.

Users have two attempts to enter a correct password. During cold start, if neither attempt succeeds, POST continues but the drive remains inaccessible. During a warm-start or restart from Windows, if neither attempt succeeds, POST halts and the user is instructed to cycle power.

Enabling DriveLock

To enable and set the DriveLock user password:

1. Power on or restart the computer.
2. As soon as the computer is powered on, repeatedly press the **F10** key until you enter Computer Setup (F10) Utility.

If you do not press **F10** at the appropriate time, you must restart the computer, then repeatedly press **F10** again to access the utility.

3. Select **Security > DriveLock Security**.
4. For each DriveLock-capable drive, select a drive by pressing **F10** to accept.
5. Under Enable/Disable DriveLock options, select **Enable**, and then press **F10** to enable DriveLock for a specific drive.



NOTE: To set the DriveLock master password, select **Master**.



CAUTION: If you forget the DriveLock password, the drive is unusable.

6. Enter a new user password (1 to 32 characters long), and then press **F10** to accept.
7. Enter the password again in the Enter New Password Again field. If you forget this password, the drive is rendered permanently disabled.
8. Select **File > Save Changes and Exit**, and then press **Enter** to accept the changes. After you press **Enter**, the computer performs a cold start before invoking the DriveLock function.

When the computer starts, you are prompted to enter the DriveLock password for each DriveLock-capable drive for which you have set a password. You have two attempts to enter the password correctly. If the password is not entered correctly, the computer attempts to start anyway. However, the boot process most likely fails because data from a locked drive cannot be accessed.

In a single drive computer, if the drive has DriveLock enabled, the computer might not be able to boot to the operating system, and might try to boot from the network or from another storage device (depending on the boot ordering options). Regardless of the outcome of the start attempts, the drive-locked drive remains inaccessible without the DriveLock password.

In a two-drive computer that has a boot drive and a data drive, you can apply the DriveLock feature to the data drive only. In this case, the computer can always start, but the data drive is accessible only when the DriveLock password is entered.

Cold starts require that you enter DriveLock passwords. However, DriveLock passwords are also required for warm starts. For example, if you boot to DOS and press **Ctrl+Alt+Del**, you must enter the DriveLock password before the computer completes the next start cycle. This warm-start behavior is consistent with the DriveLock feature.

Password security

The power-on password prevents unauthorized use of the computer by requiring entry of a password to access applications or data when the computer is powered on or restarted. The setup password specifically prevents unauthorized access to Computer Setup (F10) Utility and can also be used as an override to the power-on password. When prompted for the power-on password, entering the setup password instead enables access to the computer.

You can establish a network-wide setup password to enable the system administrator to log in to all network systems to perform maintenance without needing to know the power-on password.

Establishing a setup password using Computer Setup (F10) Utility

Establishing a setup password through Computer Setup (F10) Utility prevents reconfiguration of the computer (through the use of Computer Setup (F10) Utility) until the password is entered.

To establish a setup password using Computer Setup (F10) menu:

1. Power on or restart the computer.
2. As soon as the computer is powered on, press and hold **F10** until you enter Computer Setup (F10) Utility. Press **Enter** to bypass the title screen, if necessary.

If you do not press **F10** at the appropriate time, you must restart the computer, and then press and hold **F10** again to access the utility.

If you are using a PS/2 keyboard, you might see a keyboard error message. Disregard it.

3. Select **Security > Setup Password** and then follow the onscreen instructions.
4. Before exiting, select **File > Save Changes and Exit**.

Establishing a power-on password using computer setup

Establishing a power-on password through Computer Setup (F10) Utility prevents access to the computer when power is connected, unless you specify the password. When a power-on password is set, Computer Setup (F10) Utility presents Password Options in the Security menu. The password options include Network Server Mode and Password Prompt on Warm Boot.

When Network Server Mode is disabled, you must enter the password when the computer is powered on, when the key icon appears on the monitor. When Password Prompt on Warm Boot is enabled, you must enter the password. The password must also be entered each time the computer is restarted. When Network Server Mode is enabled, the password prompt is not presented during POST, but an attached PS/2 keyboard remains locked until you enter the power-on password.

To enable Network Server Mode, you must set a power-on password under **Advanced > Password Options**. This option enables the computer to start without requiring the power-on password, but the keyboard and mouse are locked until you enter the password. The keyboard LEDs rotate constantly when the computer is in locked mode.

To establish a power-on password through the Computer (F10) menu:

1. Power on or restart the computer.
2. As soon as the computer is powered on, press and hold **F10** until you enter Computer Setup (F10) Utility. Press **Enter** to bypass the title screen, if necessary.

If you do not press **F10** at the appropriate time, you must restart the computer and then press and hold **F10** again to access the utility.

If you are using a PS/2 keyboard, you might see a keyboard error message. Disregard it.
3. Select **Security > Power-On Password** and then follow the onscreen instructions.
4. Before exiting, select **File > Save Changes and Exit**.

Entering a power-on password

To enter a power-on password:

1. Restart the computer.
2. When the key icon appears on the monitor, enter the current password, and then press **Enter**.

Type carefully. For security reasons, the characters you enter do not appear on the screen.

If you enter the password incorrectly, a broken key icon appears. Try again. After three unsuccessful tries, you will enter the F10 setup screen with read-only permission. (See the Setup Browse Mode option under the Power-On options.)

Entering a setup password

If a setup password has been established on the computer, you will be prompted to enter it each time you run Computer Setup (F10) Utility.

To enter a setup password:

1. Restart the computer.
2. As soon as the computer is powered on, press and hold **F10** until you enter Computer Setup (F10) Utility. Press **Enter** to bypass the title screen, if necessary.

If you do not press **F10** at the appropriate time, you must restart the computer and press and hold **F10** again to access the utility.

If you are using a PS/2 keyboard, you might see a keyboard error message. Disregard it.

3. When the key icon appears on the monitor, enter the setup password, and press **Enter**.

Type carefully. For security reasons, the characters you enter do not appear on the screen.

If you enter the password incorrectly, a broken key icon appears. Try again. After three unsuccessful tries, you must restart the computer before you can continue.

Changing a power-on or setup password

To change a power-on or setup password:

1. Restart the computer.
2. To change the power-on password, go to step 4.
3. To change the setup password, as soon as the computer is powered on, press and hold **F10** until you enter Computer Setup (F10) Utility. Press **Enter** to bypass the title screen, if necessary.

If you do not press **F10** at the appropriate time, you must restart the computer, and then press and hold the **F10** key again to access the utility.

If you are using a PS/2 keyboard, you might see a keyboard error message. Disregard it.

4. When the key icon appears, enter the current password, a slash (/) or alternative delimiter character, the new password, another slash (/) or alternative delimiter character, and the new password again as shown:

current password/new password/new password

For information about the alternative delimiter characters, see [National keyboard delimiter characters on page 70](#).

Type carefully. For security reasons, the characters you enter do not appear on the screen.

5. Press **Enter**.

The new password takes effect the next time you power on the computer.

The power-on and setup passwords can also be changed using the Security options in Computer Setup (F10) Utility.

Deleting a power-on or setup password

To delete a power-on or setup password:

1. Power on or restart the computer.
2. Choose from the following:
 - To delete the power-on password, go to step 4.
 - To delete the setup password, as soon as the computer is powered on, press and hold **F10** until you enter Computer Setup (F10) Utility. Press **Enter** to bypass the title screen, if necessary.

If you do not press F10 at the appropriate time, you must restart the computer and then press and hold F10 again to access the utility.

Use the appropriate operating system shutdown process.

3. When the key icon appears, enter the current password followed by a slash (/) or alternative delimiter character: *current password/*.

For information about the alternative delimiter characters see the following section.

4. Press **Enter**.

National keyboard delimiter characters

Each keyboard meets country-specific requirements. The syntax and keys you use for changing or deleting passwords depend on the keyboard included with the computer.

Language	Delimiter	Language	Delimiter	Language	Delimiter
Arabic	/	Greek	-	Russian	/
Belgian	=	Hebrew	.	Slovakian	-
BHCSY*	-	Hungarian	-	Spanish	-
Brazilian	/	Italian	-	Swedish/Finnish	/
Chinese	/	Japanese	/	Swiss	-
Czech	-	Korean	/	Taiwanese	/
Danish	-	Latin American	-	Thai	/
French	!	Norwegian	-	Turkish	.
French Canadian	é	Polish	-	U.K. English	/
German	-	Portuguese	-	U.S. English	/

* Bosnia-Herzegovina, Croatia, Slovenia, and Yugoslavia

Clearing passwords

If you forget the password, you cannot access the computer.

For instructions about clearing passwords, see [Configuring password security and resetting CMOS on page 153](#).

Chassis security

Smart Cover Sensor (optional)

The optional Smart Cover Sensor is a combination of hardware and software technology that alerts you if the interior or the computer is accessed (provided the sensor has been configured in Computer Setup (F10) Utility). The sensor alerts you when the side panel is removed.

Three levels of protection are available:

Level	Setting	Description
Level 0	Disabled	Sensor* is disabled (default).
Level 1	Notify User	When the computer restarts, a message indicates that the computer has been opened or the access panel has been removed.
Level 2	Setup Password	When the computer restarts, a message indicates that the computer has been opened or the access panel has been removed. You must enter the setup password to continue.

* Smart Cover Sensor settings can be changed using Computer Setup (F10) Utility.

Setting the protection level

To set the Smart Cover Sensor protection level:

1. Power on or restart the computer.
2. During startup, press and hold the **F10** key until you enter Computer Setup (F10) Utility. Press **Enter** to bypass the title screen, if necessary.

 **NOTE:** If you do not press the **F10** key at the appropriate time, you must restart the computer, and then press and hold the **F10** key again to access Computer Setup (F10) Utility.

If you are using a PS/2 keyboard, you might see a keyboard error message. Disregard it.

3. Select **Security > Smart Cover > Cover Removal Sensor**, and follow the onscreen instructions.
4. Before exiting, select **File > Save Changes and Exit**.

Side access panel solenoid lock

The side access panel solenoid lock (available only on specific workstations) secures the side access panel to the chassis. The solenoid is controlled by a local or remote signal.

To lock the solenoid, set a password for the solenoid lock in Computer Setup (F10) Utility. To unlock the solenoid, remove the solenoid lock password in Computer Setup (F10) Utility.

The solenoid lock FailSafe Key (available from HP) is a device for manually disabling the solenoid lock. You will need the FailSafe Key in case of forgotten password, power loss, or computer malfunction.

Cable lock (optional)

To prevent theft, you can attach a keyed cable lock to the rear chassis panel. This cable lock attaches to the chassis and secures it to the work area.

Fault notification and recovery

Fault notification and recovery features combine innovative hardware and software technology to prevent the loss of critical data and minimize unplanned downtime.

If the computer is connected to a network that is managed by HP CMS, the computer sends a fault notice to the network management application. With HP CMS, you can also remotely schedule diagnostics to run on managed PCs and create a summary report of failed tests.

Drive Protection System

The Drive Protection System (DPS) is a diagnostic tool built into hard disk drives and is installed in select HP computers. The DPS helps diagnose problems that might result in unwarranted hard disk drive replacement.

When HP computers are built, each installed hard disk drive is tested using the DPS, and a permanent record of key information is written onto each drive. Every time the DPS is run, test results are written to the hard disk drive. The service provider can use this information to help diagnose conditions that required you to run the DPS software.

ECC fault prediction

When the computer encounters an excessive number of error checking and correcting (ECC) memory errors, it displays a local alert message. This message contains information about the errant DIMM, enabling you to take action before you experience noncorrectable memory errors. ECC DIMMs are standard on this computer.

Thermal sensors

Several thermal sensors in the HP workstation regulate computer fans to maintain an acceptable, efficient chassis temperature.

Programmable power button (Windows only)

With ACPI (Advanced Configuration and Power Interface) enabled, you can customize the behavior of the power button so that rather than powering down, the workstation enters sleep mode (low power state), or hibernate mode (very low power state). This lets you go to standby without closing applications, and then return to the same operational state without any data loss.

Changing the power button configuration (Windows only)

Windows 7

1. Select **Start**, and then select **Control Panel > System and Security > Power Options**.
2. On the left side of the screen, select **Change What the Power Buttons Do**.
3. Select the desired options.

If you choose Sleep or Hibernate, you can press the power button to initiate standby, and then press it again to exit standby and return to your work. To completely turn off the workstation, select **Start > Shut Down**.

 **CAUTION:** To reduce the risk of data loss, do not use the power button to turn off the computer unless the system is not unresponsive.

 **NOTE:** If the computer is unresponsive, press and hold the power button for four seconds to completely turn off power to the computer.

Windows 8

1. Point to the upper-right or lower-right corner of the Start screen to display the charms.
2. In the Search field, type `control`.
3. On the left side of the screen select **Control Panel**, and then select **System and Security > Power Options**.
4. In Power Options Properties, select **Choose What the Power Button Does**.
5. Select the desired options.

3 Component replacement information and guidelines

This chapter provides warnings, cautions, information, and guidelines for removal and replacement procedures. It does not document the step-by-step procedures.



IMPORTANT: Removal and replacement procedures are now available in videos on the HP website.

Go to the HP Customer Self Repair Services Media Library at <http://www.hp.com/go/sml>.

This chapter includes these topics:

- [Warnings and cautions](#)
- [Service considerations](#)
- [Product recycling](#)
- [Component replacement guidelines](#)

Warnings and cautions



WARNING! These symbols on any surface or area of the equipment indicate the following:



Presence of a hot surface or hot component. If this surface is contacted, the potential for injury exists. To reduce the risk of injury from a hot component, let the surface cool before touching.



Presence of an electrical shock hazard. To reduce the risk of injury from electrical shock, do not open any enclosed area marked with this symbol.



Product must always be lifted by two persons to avoid personal injury due to product weight.



WARNING! To reduce the risk of electric shock or damage to your equipment:

- Do not disable the power cord grounding plug. The grounding plug is an important safety feature.
- Plug the power cord in a grounded (earthed) outlet that is easily accessible at all times.
- Disconnect power from the equipment by unplugging the power cord from the electrical outlet.



WARNING! To reduce the risk of serious injury, read the *Safety & Comfort Guide*. It describes proper computer setup, posture, health, and work habits for computer users, and provides important electrical and mechanical safety information. This guide is located at <http://www.hp.com/ergo>.



WARNING! Do not use the front bezel as a handle or lifting point when lifting or moving the computer. Lifting the computer from the front bezel, or lifting it incorrectly, could cause the computer to fall, causing possible injury to you and damage to the computer. To properly and safely lift the computer, lift from the bottom of the computer.

⚠ CAUTION: Static electricity can damage the electronic components of the computer. To prevent damage to the computer, observe the following Electrostatic Discharge (ESD) precautions while servicing the computer:

- Discharge static electricity by briefly touching a grounded metal object before you begin.
- Work on a static-free mat.
- Wear a static strap to ensure that any accumulated electrostatic charge is discharged from your body to the ground.
- Create a common ground for the equipment you are working on by connecting the static-free mat, static strap, and peripheral units to that piece of equipment.

📝 NOTE: HP accessories are for use in HP products. They have been extensively tested for reliability and are manufactured to high quality standards.

Service considerations

Tools and software requirements

The tools necessary for computer component removal and installation are:

- Torx T-15 driver
- Flat blade and cross-tip screwdrivers
- Diagnostics software

Electrostatic discharge (ESD) information

Generating static	Different activities generate different amounts of static electricity through electrostatic discharge (ESD). Static electricity increases as humidity decreases.																											
	CAUTION: Static electricity in the amount of 700 volts might degrade a product.																											
	<table><thead><tr><th rowspan="2">Event</th><th colspan="3">Relative humidity</th></tr><tr><th>55%</th><th>40%</th><th>10%</th></tr></thead><tbody><tr><td>Walking across carpet</td><td>7,500V</td><td>15,000V</td><td>35,000V</td></tr><tr><td>Walking across vinyl floor</td><td>3,000V</td><td>5,000V</td><td>12,000V</td></tr><tr><td>Motions of bench worker</td><td>400V</td><td>800V</td><td>6,000V</td></tr><tr><td>Removing bubble pack from PCB</td><td>7,000V</td><td>20,000V</td><td>26,500V</td></tr><tr><td>Packing PCBs in foam-lined box</td><td>5,000V</td><td>11,000V</td><td>21,000V</td></tr></tbody></table>	Event	Relative humidity			55%	40%	10%	Walking across carpet	7,500V	15,000V	35,000V	Walking across vinyl floor	3,000V	5,000V	12,000V	Motions of bench worker	400V	800V	6,000V	Removing bubble pack from PCB	7,000V	20,000V	26,500V	Packing PCBs in foam-lined box	5,000V	11,000V	21,000V
Event	Relative humidity																											
	55%	40%	10%																									
Walking across carpet	7,500V	15,000V	35,000V																									
Walking across vinyl floor	3,000V	5,000V	12,000V																									
Motions of bench worker	400V	800V	6,000V																									
Removing bubble pack from PCB	7,000V	20,000V	26,500V																									
Packing PCBs in foam-lined box	5,000V	11,000V	21,000V																									

Preventing ESD equipment damage	Many electronic components are sensitive to ESD. Circuitry design and structure determine the degree of sensitivity. The following packaging and grounding precautions are necessary to prevent damage to electric components and accessories: <ul style="list-style-type: none">• Transport products in static-safe containers such as tubes, bags, or boxes, to avoid hand contact.• Protect electrostatic parts and assemblies with nonconductive or approved containers or packaging.• Keep electrostatic-sensitive parts in their containers until they arrive at static-free stations.• Place items on a grounded surface before removing them from containers.
--	--

- When handling or touching a sensitive component or assembly, ground yourself by touching the chassis.
- Avoid contact with pins, leads, or circuitry.
- Place reusable electrostatic-sensitive parts from assemblies in protective packaging or nonconductive foam.

Personal grounding methods and equipment

Use the following items to help prevent ESD damage:

- **Wrist straps** — These are flexible straps with a maximum of one megohm \pm 10% resistance in the ground cords. To provide a proper ground, wear the strap against bare skin. The ground cord must be connected and fit snugly into the banana plug connector on the grounding mat or computer.
- **Heel straps, toe straps, and boot straps** — These can be used at standing computers and are compatible with most types of shoes or boots. On conductive floors or dissipative floor mats, use them on both feet with a maximum of one megohm \pm 10% resistance between the operator and ground.

Static shielding materials

Static shielding materials provide the following levels of protection.

Method	Voltage
Antistatic plastic	1,500V
Carbon-loaded plastic	7,500V
Metalized laminate	15,000V

Grounding the work area to prevent static damage

- Cover the work surface with approved static-dissipative material. Use a wrist strap connected to the work surface, and properly grounded tools and equipment.
- Use static-dissipative mats, foot straps, or air ionizers to give added protection.
- Handle electrostatic-sensitive components, parts, and assemblies by the case or PCB laminate. Handle them only in static-free work areas.
- Disconnect power and input signals before inserting and removing connectors or test equipment.
- Use fixtures made of static-safe materials when fixtures must directly contact dissipative surfaces.
- Keep work area free of nonconductive materials, such as plastic assembly aids and Styrofoam.
- Use field service tools (such as cutters, screwdrivers, and vacuums) that are conductive.

Recommended ESD prevention materials and equipment

- Antistatic tape
- Antistatic smocks, aprons, and sleeve protectors
- Conductive bins and other assembly or soldering aids
- Conductive foam
- Conductive tabletop computers with a ground cord of one megohm \pm 10% resistance
- Static-dissipative table or floor mats with a hard-tie to ground
- Field service kits
- Static awareness labels
- Wrist straps and footwear straps providing one megohm \pm 10% resistance
- Material-handling packages
- Conductive plastic bags
- Conductive plastic tubes
- Conductive tote boxes
- Opaque shielding bags
- Transparent metallized shielding bags
- Transparent shielding tubes

Product recycling

HP encourages customers to recycle used electronic hardware, HP original print cartridges, and rechargeable batteries.

For information about recycling HP components or products, see <http://www.hp.com/go/recycle>.

Component replacement guidelines

This section provides information and guidelines for removal and replacement procedures. It does not document the step-by-step procedures.



IMPORTANT: Removal and replacement procedures are now available in videos on the HP website.

Go to the HP Customer Self Repair Services Media Library at <http://www.hp.com/go/sml>. In Media Selection, choose the **Desktops & Workstations** product category and the **Personal Workstations** product family, then choose your platform

This chapter provides guidelines for removal and replacement procedures.

[Battery on page 77](#)

[Cable management on page 78](#)

[CPU \(processor\) and CPU heatsink on page 79](#)

[Expansion slots on page 80](#)

[Hard disk drives and optical disc drives on page 91](#)

[Memory on page 98](#)

[Power supply specifications on page 104](#)

[System board on page 106](#)

Battery

The battery that comes with the computer provides power to the real-time clock and has a minimum lifetime of about three years. Observe the following warning and caution when replacing the battery.



WARNING! HP Z Series Workstations use lithium batteries. There is a risk of fire and chemical burn if the battery is handled improperly. Do not disassemble, crush, puncture, short external contacts, dispose of in water or fire, or expose battery to temperatures higher than 60°C (140°F).



CAUTION: Before removing the battery, back up the CMOS settings in case they are lost when the battery is removed. Use Computer Setup (F10) Utility to back up the settings.



NOTE: Do not dispose of batteries, battery packs, and accumulators with general household waste.

Cable management

Proper routing of the internal cables is critical to the operation of the workstation. Follow good cable management practices when removing and installing components.

- Handle cables with care to avoid damage.
- Apply only the tension required to seat or unseat cables during insertion or removal from the connector.
- When possible, handle cables by the connector or pull-strap.
- Route cables in such a way that they cannot be caught or snagged by parts being removed or replaced.
- Keep cables away from direct contact with major heat sources, such as the heatsink. (Some air flow guides have a cable guide that lets you route cables safely around the heatsink.)
- Do not jam cables on top of expansion cards or DIMMs. Circuit cards and DIMMs are not designed to take excessive pressure.
- Keep cables clear of movable or rotating parts (such as the power supply and drive cage) to prevent them from being cut or crimped when the component is lowered into its normal position.
- In all cases, avoid bending or twisting the cables. Do not bend any cable sharply. A sharp bend can break the internal wires.
- Never bend a SATA data cable tighter than a 30 mm (1.18 in) radius.
- Never crease a SATA data cable.
- Do not rely on components like the drive cage, power supply, or computer cover to push cables down into the chassis. Always position the cables to lay properly by themselves or in the cable guides and chassis areas designed for cable routing.

When removing the power supply power cable from the connector on the system board, always follow these steps:

1. Squeeze on the top of the retaining latch attached to the cable end of the connector.
2. Grasp the cable end of the connector and pull it straight out.

 **CAUTION:** Always pull the connector — NEVER pull on the cable. Pulling on the cable could damage the cable and result in a failed power supply.

CPU (processor) and CPU heatsink

⚠ CAUTION: Observe the following cautions when removing or replacing the heatsink.

- When removing the heatsink, loosen all screws a little at a time to ensure the CPU remains level. Do *not* fully loosen one screw, and then move on to the next.
- After you remove the CPU heatsink from the chassis, use alcohol and a soft cloth to clean the thermal compound residue from the CPU and the heatsink, allowing the alcohol on the CPU and CPU heatsink to dry completely.
- If you are reusing the original heatsink, apply thermal compound to the center of the CPU top surface.
- If you are using a new CPU heatsink, do not apply thermal compound to the CPU because the new heatsink already has thermal compound applied to the heatsink surface. Instead, remove the thermal compound protective liner from the bottom of the new heatsink.
- Do not overtighten the heatsink screws. Overtightening can strip the threads in the chassis.
- Do not fully tighten one screw and then move on to the next. Instead, tighten all screws a little at a time, ensuring that the CPU remains level.

CAUTION: Observe the following cautions when removing or replacing the CPU.

- If you are installing a second CPU, it must be of the same type as the first CPU.
 - Internal components might be powered even when the computer is off. To prevent damage, disconnect the computer power cord before you remove or install a component.
 - The CPU socket contacts and pads are extremely fragile. Do not touch the CPU socket contacts or the gold pads underneath the CPU. Use extreme care and handle the CPU only by the edges.
 - The CPU socket contacts are delicate and bend easily. To avoid bending the contacts, use extreme care when installing the CPU in the socket.
 - Installing a processor incorrectly can damage the system board. Contact an HP authorized reseller or service provider to install the processor. If you plan to install the processor yourself, view the entire remove and replace video before you begin.
 - Failure to follow the computer preparation instructions can result in an improperly installed processor, causing extensive computer damage.
-

Expansion slots

This section identifies and describes computer expansion card slots, and presents card configuration information.

Go to <http://www.hp.com/go/quickspecs> to learn which graphics cards are supported in the workstation, how much memory each graphics card includes, and graphics card power requirements.

Card configuration restrictions for power supplies

CAUTION: To prevent damage, the overall power consumption of the computer (including I/O cards, CPU, and memory) must not exceed the maximum rating of the computer power supply. For power supply information, see [Power supply specifications on page 104](#).

Choosing an expansion card slot

Whenever possible, use the following tips to help you select the proper slot for an expansion card:

- Use the PCIe x16 slot for the primary graphics card. If you do not use this slot for the graphics card, only cards certified as After Market Options are supported.
- Install a second graphics card in the other PCIe x16 slot.
- Install a card in a slot that most closely matches its interface technology:
 - Install a PCIe Gen1 x16 or a PCIe Gen1 x8 card in the PCIe Gen2 x16 slot.
 - Install a PCIe Gen1 x4 card in the PCIe Gen1 x4 slot.
 - Install a PCIe Gen1 x1 card in the PCIe Gen1 x1 slot.
 - Install a PCI card in the PCI slot.
 - Whenever possible, install a PCIe x1 card in an x1 slot.
- Leave as much space as possible between cards (especially graphics cards) to allow heat to dissipate more efficiently.
- For best operational efficiency, select a slot that:
 - Electrically matches the number of PCIe card lanes (for example, x1 in an x1 slot).
 - Has more lanes electrically.
 - Has fewer lanes, but is closer to your needs. For example, place an x16 card in an x4 slot, and an x4 card in a an x1 slot.
- An x1 connector supports an x1 card only. While an x1 card can be inserted into a larger slot, this may limit potential future card placement.

HP Z220 SFF Workstation slot identification and description

Maximum power used by all slots must not exceed total system power and is subject to configuration limitations.

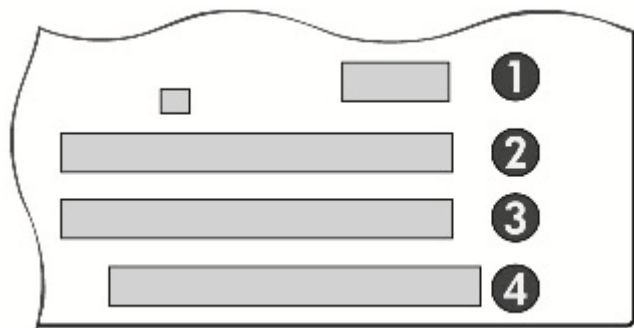

Slot	Type	Mechanical compatibility	Electrical compatibility
1	PCIe2 x1	x1	x1
2	PCIe2 x16 (4)	x16	x4
3	PCIe3 x16	x16	x16
4	PCI 32/33	PCI	PCI

 **NOTE:** The PCIe designators indicate the mechanical connector size and number of electrical PCIe lanes routed to an expansion slot. For example, x16 (8) means that the expansion slot is mechanically a x16 length connector, with 8 PCIe lanes supported.

HP Z220 SFF Workstation installation sequence recommendations

Load order	Card description	Slot 1	Slot 2	Slot 3	Slot 4
1	PCIe graphic card			Only	
2	Second PCIe graphic card		Only		
3	PCIe audio card	1st	2nd		
4	PCIe NIC card	1st	2nd		
5	PCIe 1394a card	1st	2nd		
6	PCIe Wireless card	1st	2nd		
7	Second serial port kit	1st	2nd		
8	Parallel port kit	1st	2nd		
9	eSATA bulkhead kit	1st	2nd		3rd

NOTE: Slot sequenced from the rear I/O aperture to the board edge.

HP Z220 CMT Workstation slot identification and description

Maximum power used by all slots must not exceed total system power and is subject to configuration limitations.

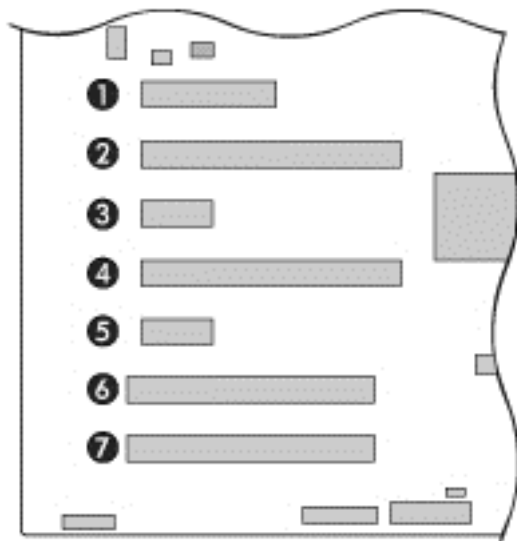

Slot	Type	Mechanical compatibility	Electrical compatibility
1	PCIe2 x8 (4)	x8	x4
2	PCIe3 x16	x16	x16
3	PCIe2 x1	x1	x1
4	PCIe2 x16 (4)	x16	x4
5	PCIe2 x1	x1	x1
6	PCI 32/33	PCI	PCI
7	PCI 32/33	PCI	PCI

NOTE: The PCIe designators indicate the mechanical connector size and number of electrical PCIe lanes routed to an expansion slot. For example, x16 (8) means that the expansion slot is mechanically a x16 length connector, with 8 PCIe lanes supported.

Slot two is the primary graphics slot; slot four is the secondary graphics slot.

Slots one, two, and four use open-ended PCIe connectors, so a PCIe x16 card can be inserted. Graphics cards greater than 75 watts require the use of an auxiliary power cable adapter.

HP Z220 CMT Workstation installation sequence recommendations

Load order	Card description	Slot 1	Slot 2	Slot 3	Slot 4	Slot 5	Slot 6	Slot 7
1	PCIe graphic card		Only					
2	Second PCIe graphic card				Only			
3	PCIe NIC card			1st	3rd	2nd		
4	PCIe 1394 card	1st		2nd		3rd		
5	PCIe USB3.0 card	1st		2nd				
6	PCIe audio card	1st		2nd		3rd		
7	eSATA bulkhead kit					3rd	2nd	1st
8	Parallel port kit							Only
9	Second serial port kit						2nd	1st

NOTE: Slot sequenced from the rear I/O aperture to the board edge.

HP Z420 Workstation slot identification and description

Maximum power used by all slots must not exceed total system power and is subject to configuration limitations.

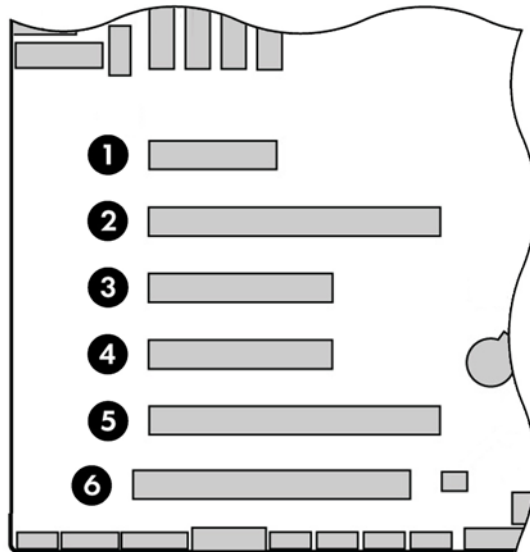

Slot	Type	Mechanical compatibility	Electrical compatibility
1	PCIe2 x4 (1)	x4	x1
2	PCIe3 - x16	x16	x16
3	PCIe2 - x8 (4)	x8	x4
4	PCIe3 x8	x8	x8
5	PCIe3 x16	x16	x16
6	PCI 32/33	PCI	PCI

NOTE: The PCIe designators indicate the mechanical connector size and number of electrical PCIe lanes routed to an expansion slot. For example, x16 (8) means that the expansion slot is mechanically a x16 length connector, with 8 PCIe lanes supported.

Slot two is the primary graphics slot; slot five is the secondary graphics slot.

Slots one, three, and four use open-ended PCIe connectors, so a PCIe x16 card can be inserted. Graphics cards greater than 75 watts require the use of an auxiliary power cable adapter.

HP Z420 Workstation installation sequence recommendations

Load order	Card description	Slot 1	Slot 2	Slot 3	Slot 4	Slot 5	Slot 6
1	First PCIe graphic card		Only				
2	Second PCIe graphic card or Tesla C2075					Only	
3	Third PCIe graphic card				Only		
4	Fourth PCIe graphic card			Only			
5	SAS card			2nd	1st	3rd	
6	PCIe 1394b card	1st		2nd			
7	PCIe audio card	1st		2nd	3rd	4th	
8	PCIe NIC card (LAN)	1st		2nd	3rd	4th	
9	e-SATA bulkhead kit			2nd	3rd		1st
10	Second serial port kit			2nd	3rd		1st

NOTE: Slot sequenced from the rear I/O aperture to the board edge.

HP Z620 Workstation slot identification and description

Maximum power used by all slots must not exceed total system power and is subject to configuration limitations.

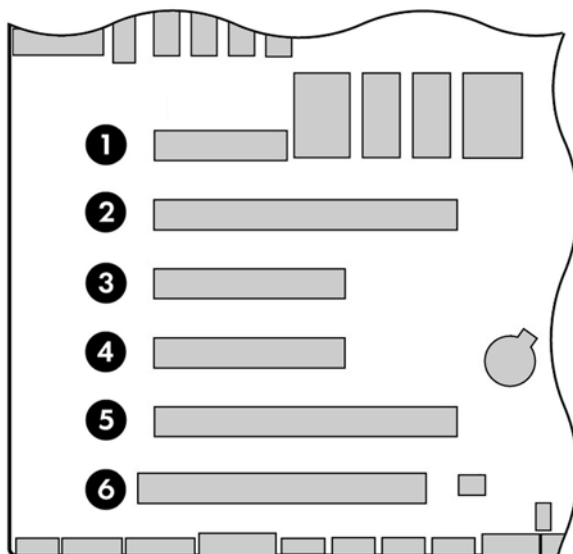

 **NOTE:** Slot 1 is not available in dual processor configurations.

Slot	Type	Mechanical compatibility	Electrical compatibility
1	PCIe2 x4 (1)	x4	x1
2	PCIe3 - x16	x16	x16
3	PCIe2 - x8 (4)	x8	x4
4	PCIe3 x8	x8	x8
5	PCIe3 x16	x16	x16
6	PCI 32/33	PCI	PCI

 **NOTE:** The PCIe designators indicate the mechanical connector size and number of electrical PCIe lanes routed to an expansion slot. For example, x16 (8) means that the expansion slot is mechanically a x16 length connector, with 8 PCIe lanes supported.

 **NOTE:** Slots two, four, and five are PCIe GEN3 slots. Slot two is the primary graphics slot; slot five is the secondary graphics slot.

Slots three and four use open-ended PCIe connectors, so a PCIe x16 card can be inserted. This allows the workstation to support more PCIe x16 expansion cards. A x16 card typically trains and runs at the maximum lane width available by the expansion slot. The card runs at the reduced lane width, with a corresponding performance decrease. Graphics cards greater than 75 watts require the use of an auxiliary power cable adapter.

HP Z620 Workstation installation sequence recommendations

Load order	Card description	Slot 1	Slot 2	Slot 3	Slot 4	Slot 5	Slot 6
1	Second System Board (Riser)	Only					
2	First PCIe graphic card		Only				
3	Second PCIe graphic card or High Performance GPU Compute card					Only	
4	PCIe 1394b card			Only			
5	Third PCIe graphics card			Only			
6	Fourth PCIe graphics card				Only		
7	Controller card			1st	2nd	3rd	
8	PCIe audio card	4th		1st	2nd	3rd	
9	PCIe Network (LAN) card	4th		1st	2nd	3rd	
10	eSATA bulkhead kit			4th	1st	2nd	3rd
11	Serial port bulkhead				3rd	2nd	1st

NOTE: Slot sequenced from the rear I/O aperture to the board edge.

HP Z820 Workstation slot identification and description

Maximum power used by all slots must not exceed total system power and is subject to configuration limitations.

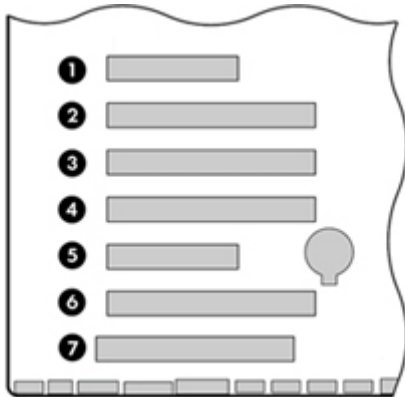

Slot	Type	Mechanical compatibility	Electrical compatibility
1	PCIe3 x8 (4) — CPU0	x8	x4
2	PCIe3 x16 — CPU0	x16	x16
3	PCIe3 x16 (8) — CPU1	x16	x8
4	PCIe3 x16 — CPU1	x16	x16
5	PCIe2 x8 (4) — CPU0	x8	x4
6	PCIe3 x16 — CPU0	x16	x16
7	PCI 32/33 — CPU0	PCI	PCI

NOTE: The PCIe designators indicate the mechanical connector size and number of electrical PCIe lanes routed to an expansion slot. For example, x16(8) means that the expansion slot is mechanically a x16 length connector, with 8 PCIe lanes supported.

NOTE: Slots one and five use open-ended PCIe connectors, so a PCIe x16 card can inserted. This allows the workstation to support more PCIe x16 expansion cards. A x16 card typically trains and runs at the maximum lane width available by the expansion slot. The card runs at the reduced lane width, with a corresponding performance decrease.

NOTE: A eighth slot opening in the chassis has no corresponding expansion connector on the system board. This slot opening is provided for devices that do not require system board card plug-in capability.

NOTE: It is normal for the expansion card retention clamp to have a slight (5-10 degree) angle when closed. If the angle is greater than this, open the clamp and ensure that all cards are properly seated and all the brackets are mated to the chassis, then re-close the clamp.

HP Z820 Workstation installation sequence recommendations

Load order	Card description	Type	Slot 0	Slot 1	Slot 2	* Slot 3	* Slot 4	Slot 5	Slot 6	Slot 7
1	1st high performance GPU Compute card	PCIe-x16					2nd		1st ¹	
2	2nd high performance GPU Compute card (requires 2nd CPU and 1125w PSU)	PCIe-x16					Only			
3	1st PCIe graphics card	PCIe-x16			Only					
4	2nd PCIe graphics card	PCIe-x16					2nd		1st ¹	
5	3rd PCIe graphics (requires 2nd CPU)	PCIe-x16				2nd	1st			
6	4th PCIe graphics (requires 2nd CPU and 1125w PSU)	PCIe-x16				Only				
7	Graphics test card	PCIe-x16			1st		2nd			
8	Controller card	PCIe-x8		2nd		5th	4th	3rd	1st ²	
9	Controller card with battery	PCIe-x8		2nd		5th	4th	3rd	1st ²	
10	PCIe 1394 card	PCIe-x1						Only		
11	PCIe audio card	PCIe-x1		1st		4th	5th	2nd	3rd	
12	PCIe Network (LAN)	PCIe-x1		1st		4th	5th	2nd	3rd	
13	Mini SAS-4x bulkhead kit	N/A	1st							2nd
14	eSATA bulkhead kit	N/A	1st							2nd

* Slots 3 and 4 require second CPU.

1: If a second graphics card is used with a High Performance GPU Compute card, place the High Performance GPU Compute card in Slot 6 and the second graphics in the alternate slot(s).

2: If a Controller card is being used with a High Performance GPU Compute card or second graphics card, place the High Performance GPU Compute card/graphics card in Slot 6 and the RAID card in the alternate slot(s).

NOTE: Slot sequenced from the rear I/O aperture to the board edge.

Hard disk drives and optical disc drives

Handling hard disk drives

 **CAUTION:** Take proper precautions when handling hard disk drives to prevent loss of work and damage to the computer or drive.

- Do not remove hard drives from the shipping package for storage. Keep hard drives in their protective packaging until they are mounted in the computer.
- Always shut down the operating system, turn off the power, and unplug the power cord. Never remove a drive while the computer is on or in standby mode.
- Before handling a drive, make sure you discharge static electricity. While handling a drive, avoid touching the connector.
- Handle a drive carefully. Do not drop it from any height.
- To prevent possible ESD damage when the drive is installed, connect the drive power cable before connecting the data cable. This discharges accumulated static electricity through the drive power cable to the computer chassis.
- Do not use excessive force when inserting a drive.
- Avoid exposing a hard drive to liquids, temperature extremes, or products that have magnetic fields such as monitors or speakers.
- If you must mail a drive, use a bubble-pack mailer or other protective packaging and label the package “Fragile: Handle With Care.”

Removal and replacement tips

- To verify the type, size, and capacity of the storage devices installed in the computer, run **Computer Setup (F10) Utility**.
- Adding a new drive may require that you make new connections from the drive to the system board. Note that:
 - The primary Serial ATA (SATA) hard drive must be connected to the dark blue primary SATA connector on the system board labeled SATA0.
 - Connect a secondary hard drive to SATA.
 - Connect SATA optical drives to the black SATA2 connector.
 - Connect an optional eSATA adapter cable to the black ESATA connector on the system board.
 - Connect a media card reader USB cable to the USB connector on the system board labeled MEDIA. If the media card reader has a 1394 port, connect the 1394 cable to the 1394 PCI card.

Drive installation and cabling scenarios

This section presents cabling guidelines for the most common maximum storage configurations. If you add or remove drives, HP recommends you follow these guidelines for highest drive performance and efficient cable routing.

HP Z220 SFF Workstations — SATA cable connection guidelines

Configuration / PCA SATA connector	SATA 0	SATA 1	SATA 2	SATA 4
HDD x1 ODD x1	1st HDD	1st ODD		e-SATA
HDD x2 ODD x1	1st HDD	2nd HDD	1st ODD	e-SATA

HP Z220 CMT Workstations — SATA cable connection guidelines

Configuration / PCA SATA connector	SATA 0	SATA 1	SATA 2	SATA 3	SATA 4	SATA 5
HDD x1 ODD x1	1st HDD		1st ODD			e-SATA
HDD x1 ODD x2	1st HDD		1st ODD	2nd ODD		e-SATA
HDD x2 ODD x1	1st HDD	2nd HDD	1st ODD			e-SATA
HDD x2 ODD x2	1st HDD	2nd HDD	1st ODD	2nd ODD		e-SATA
HDD x3 ODD x1	1st HDD	2nd HDD	3rd HDD	1st ODD		e-SATA
HDD x3 ODD x2	1st HDD	2nd HDD	3rd HDD	1st ODD	2nd ODD	e-SATA

HP Z420 Workstations — Intel AHCI SATA controller guidelines

See [HP Z420 Workstation system board components on page 19](#) to determine the location of system board connectors.

 **NOTE:** Port 0 is the default port for the boot drive (the default port can be changed manually in the BIOS).

System board connector	Drive configuration scenarios			
	1	2	3	4
SATA 0	SATA HDD 1	SATA HDD 1	SATA HDD 1	SATA HDD 1
SATA 1	SATA HDD 2	SATA HDD 2	SATA HDD 2	SATA HDD 2
SATA 2	ODD 1	ODD 1	ODD 1	ODD 1
SATA 3	ODD 2	SATA HDD 3	SATA HDD 3	SATA HDD 3
SATA 4	eSATA (top)	ODD 2	SATA HDD 4	eSATA (top)
SATA 5	eSATA (bottom)	—	ODD 2	eSATA (bottom)
SCU 0	—	—	—	—
SCU 1	—	—	—	—
SCU 2	—	—	—	—
SCU 3	—	—	—	—

eSATA = external SATA (2 ports per cable assembly)

HDD = hard disk drive

ODD = optical disc drive

NOTE: Only the most common configurations are shown here.

HP Z420 Workstations — LSI 9212-4i RAID controller guidelines

See [HP Z420 Workstation system board components on page 19](#) to determine the location of system board connectors.

 **NOTE:** Hard disk drives attached to RC J8 are designated by the 9212-4i BIOS to be boot devices. If the hard disk drive connected to RC J8 is a member of a RAID array, the RAID array is the boot device.

RAID card (RC) or system board (SB) connector	Drive installation scenarios		
	1	2	3
RC J8	SAS HDD 1	SAS HDD 1-B	SATA HDD 1-B
RC J7	SAS HDD 2	SATA HDD 2-D	SAS HDD 2-D
RC J6	SAS HDD 3	SATA HDD 3-D	SAS HDD 3-D
RC J5	SAS HDD 4	SATA HDD 4-D	SAS HDD 4-D
SB SATA 0	—	—	—
SB SATA 1	—	—	—
SB SATA 2	ODD 1	ODD 1	ODD 1
SB SATA 3	ODD 2	ODD 2	ODD 2
SB SATA 4	eSATA (top)	eSATA (top)	eSATA (top)
SB SATA 5	eSATA (bottom)	eSATA (bottom)	eSATA (bottom)
SB SCU 0	—	—	—
SB SCU 1	—	—	—
SB SCU 2	—	—	—
SB SCU 3	—	—	—

eSATA = external SATA (2 ports per cable assembly)

HDD = hard disk drive

ODD = optical disc drive

NOTE: Only the most common configurations are shown here.

HP Z620 Workstations — Intel AHCI SATA controller guidelines

See [HP Z620 Workstation system board components on page 26](#) to determine the location of system board connectors.



NOTE: Port 0 is the default port for the boot drive (the default port can be changed manually in the BIOS).

System board connector	Drive installation scenarios		
	1	2	3
SATA 0	SATA HDD 1	SATA HDD 1	SATA HDD 1
SATA 1	SATA HDD 2	SATA HDD 2	SATA HDD 2
SATA 2	ODD 1	ODD 1	ODD 1
SATA 3	SATA HDD 3	SATA HDD 3	SATA HDD 3
SATA 4	SATA HDD 4	ODD 2	eSATA (top)
SATA 5	—	—	eSATA (bottom)
SCU 0	—	—	—
SCU 1	—	—	—
SCU 2	—	—	—
SCU 3	—	—	—

eSATA = external SATA (2 ports per cable assembly)

HDD = hard disk drive

ODD = optical disc drive

NOTE: If there are fewer than three hard drives in the configuration, the cables from HDD bays 1 and 2 are pre-plugged to the system board SATA ports.

NOTE: Only the most common configurations are shown here.

HP Z620 Workstations — LSI 9212-4i RAID controller guidelines

See [HP Z620 Workstation system board components on page 26](#) to determine the location of system board connectors.

 **NOTE:** Hard disk drives attached to RC J8 are designated by the 9212-4i BIOS to be boot devices. If the hard disk drive connected to RC J8 is a member of a RAID array, the RAID array is the boot device.

RAID card connector (RC) or system board connector (SB)	Drive installation scenarios		
	1	2	3
RC J8	SAS HDD 1	SAS HDD 1-B	SATA HDD 1-B
RC J7	SAS HDD 2	SATA HDD 2-D	SAS HDD 2-D
RC J6	SAS HDD 3	SATA HDD 3-D	SAS HDD 3-D
RC J5	SAS HDD 4	SATA HDD 4-D	SAS HDD 4-D
SB SATA 0	—	—	—
SB SATA 1	—	—	—
SB SATA 2	ODD 1	ODD 1	ODD 1
SB SATA 3	ODD 2	ODD 2	ODD 2
SB SATA 4	eSATA (top)	eSATA (top)	eSATA (top)
SB SATA 5	eSATA (bottom)	eSATA (bottom)	eSATA (bottom)
SB SCU 0	—	—	—
SB SCU 1	—	—	—
SB SCU 2	—	—	—
SB SCU 3	—	—	—

eSATA = external SATA (2 ports per cable assembly)

HDD = hard disk drive

ODD = optical disc drive

NOTE: If there are fewer than three hard drives in the configuration, the cables from HDD bays 1 and 2 are pre-plugged to the RAID card adapter ports.

NOTE: Only the most common configurations are shown here.

HP Z820 Workstation cabling guidelines

See [HP Z820 Workstation system board components on page 33](#) to determine the location of system board connectors.

 **NOTE:** Port 0 is the default port for the boot drive (the default port can be changed manually in the BIOS).

System board connector	Drive configuration scenarios					
	1	2	3	4	5 <i>SATA RAID 5 only</i>	6 <i>SATA RAID 5 only</i>
SAS 0	HDD 1	HDD 1	eSAS 2	HDD 1	—	—
SAS 1	HDD 2	HDD 2	eSAS 2	HDD 2	—	—
SAS 2	HDD 3	HDD 3	eSAS 2	HDD 3	—	—
SAS 3	HDD 4	HDD 4	eSAS 2	HDD 4	—	—
SAS 4	HDD 5	eSAS 1	eSAS 1	HDD 5	—	—
SAS 5	HDD 6	eSAS 1	eSAS 1	HDD 6	—	—
SAS 6	—	eSAS 1	eSAS 1	ODD 1	ODD 1	—
SAS 7	—	eSAS 1	eSAS 1	ODD 2	ODD 2	—
SATA 0	ODD 1	ODD 1	ODD 1	eSATA	eSATA	ODD 1
SATA 1	ODD 2	ODD 2	ODD 2	eSATA	eSATA	ODD 2
SCU 0	—	—	HDD 1	—	HDD 1	HDD 1
SCU 1	—	—	HDD2	—	HDD 2	HDD 2
SCU 2	—	—	HDD3	—	HDD 3	HDD 3
SCU 3	—	—	HDD4	—	HDD 4	HDD 4

eSAS 1 / eSAS 2 = external SAS (HP external SAS back panel or PCI bracket – 4 ports per cable assembly)

eSATA = external SATA (2 ports per cable assembly)

HDD = SATA or SAS hard disk drive (SCU ports are SATA only)

ODD = optical disc drive

NOTE: Only the most common configurations are shown here.

Memory

Supported DIMM configurations



NOTE: Mirroring and DIMM sparing are not supported.

Platform	Configuration
HP Z220 SFF	<ul style="list-style-type: none">• Four DIMM slots• Unbuffered ECC/nECC DIMMS only• Maximum capacity: 32 GB
HP Z220 CMT	<ul style="list-style-type: none">• Four DIMM slots• Unbuffered ECC/nECC DIMMS only• Maximum capacity: 32 GB
HP Z420	<ul style="list-style-type: none">• Eight DIMM slots• Unbuffered ECC DIMMS only• Maximum capacity: 64 GB
HP Z620	<ul style="list-style-type: none">• Eight DIMM slots (single CPU) or 12 DIMM slots (dual CPU)• Unbuffered or registered ECC DIMMS• Maximum capacity: 64 GB (single CPU), 96 GB (dual CPU)• In dual processor configurations, the workstation can be configured for NUMA or non-NUMA modes
HP Z820	<ul style="list-style-type: none">• 16 DIMM slots• Both Unbuffered ECC and Registered DIMMs• Maximum capacity: 512 GB• In dual processor configurations, the workstation can be configured for NUMA or non-NUMA modes

BIOS errors and warnings

The BIOS generates warnings/errors on invalid memory configurations:

- If the BIOS can find a valid memory configuration by disabling plugged-in memory, it does so and reports a warning during POST. The workstation can still be started. The warning will indicate the location of the failed DIMM on the system board.
- If there is no way for the BIOS to obtain a valid memory configuration by disabling plugged-in memory, the BIOS halts with a diagnostics 2006 code for memory error (five beeps and blinks).

DIMM installation guidelines

- Install only HP-approved DDR3 DIMMs

 **CAUTION:** HP ships only DIMMs that are electrically and thermally compatible with this workstation. Because third-party DIMMs might not be electrically or thermally compatible, they are not supported by HP.

- Install only HP-approved DDR3 DIMMs. See <http://www.hp.com/go/quickspecs> to find DIMMs that are compatible with the workstation.
- Do not intermix DIMMs of different technologies. ECC Unbuffered DIMMs (UDIMMs), Registered DIMMs (RDIMMs), and Load Reduced DIMMs (LRDIMMs) are supported on HP Z Series Workstations. [Supported DIMM configurations on page 98](#) specifies which technologies are supported on each platform.

 **CAUTION:** DIMMs and their sockets are keyed for proper installation. To prevent socket or DIMM damage, align these guides properly when installing DIMMs.

HP Z220 SFF Workstation DIMM installation order

Install DIMMs in this order.

 **NOTE:** If you install DIMMs of different sizes, load them in order of size, starting with largest and finishing with the smallest (largest in DIMM 1, smallest in last loaded DIMM).

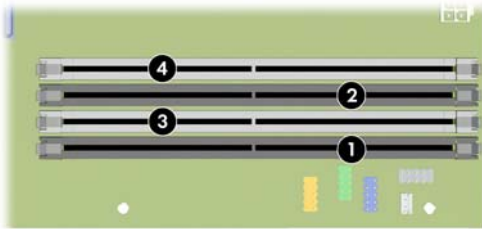

HP Z220 CMT Workstation DIMM installation order

Install DIMMs in this order.

 **NOTE:** If you install DIMMs of different sizes, load them in order of size, starting with largest and finishing with the smallest (largest in DIMM 1, smallest in last loaded DIMM).

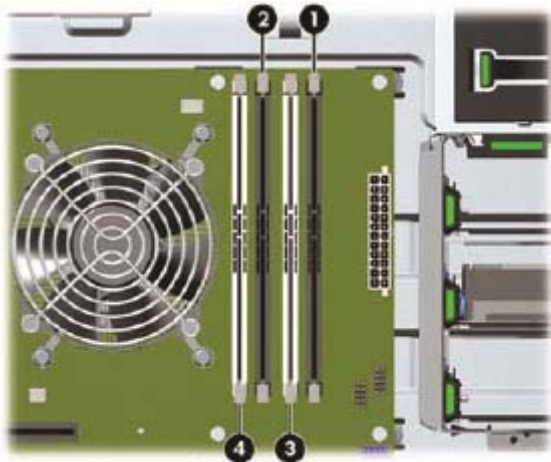

HP Z420 Workstation DIMM installation order

Install DIMMs in this order.

 **NOTE:** If you install DIMMs of different sizes, load them in order of size, starting with largest and finishing with the smallest (largest in DIMM 1, smallest in last loaded DIMM).

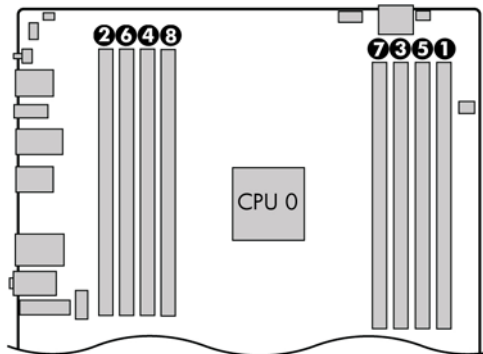

HP Z620 Workstation DIMM installation order

Install DIMMs in this order.

 **NOTE:** If you install DIMMs of different sizes, load them in order of size, starting with largest and finishing with the smallest (largest in DIMM 1, smallest in last loaded DIMM).

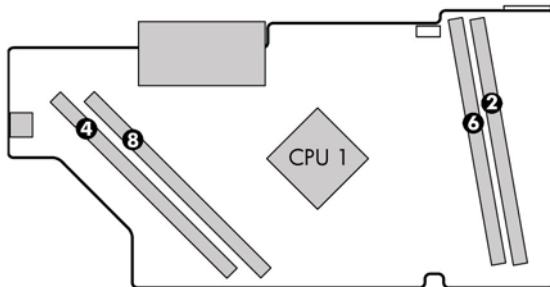
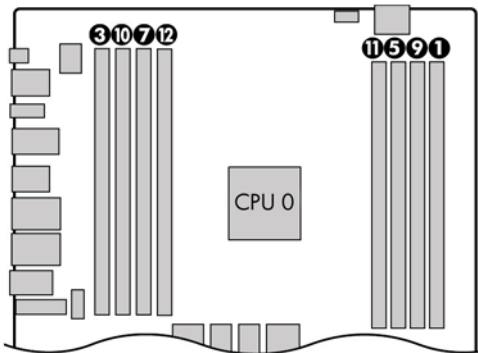
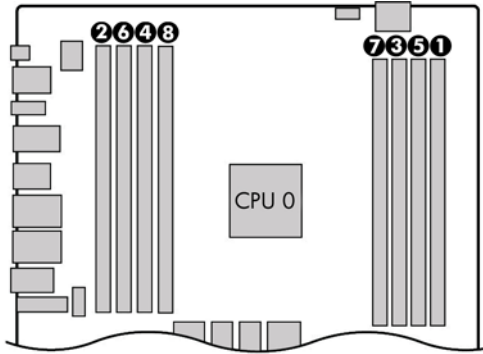

HP Z820 Workstation DIMM installation order

Install DIMMs in this order.

 **NOTE:** If you install DIMMs of different sizes, load them in order of size, starting with largest and finishing with the smallest (largest in DIMM 1, smallest in last loaded DIMM).

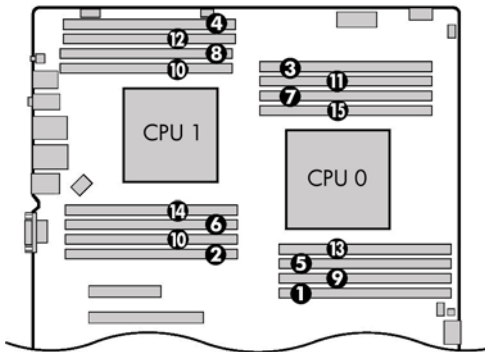
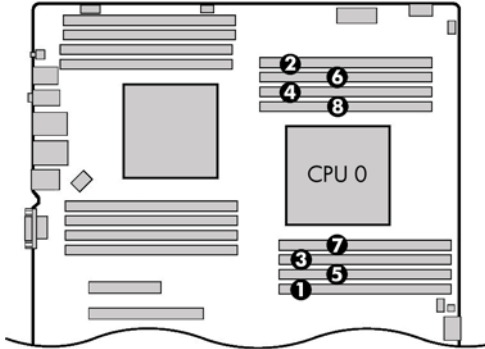

Power supply

Power supply specifications

All power supplies have these specifications:

- Wide-ranging, active Power Factor Correction (PFC)
- ENERGY STAR® qualified (configuration dependent)
- FEMP Standby Power compliant @115V (<1 W in S5 – Power Off)
- Surge tolerant (withstands power surges up to 2000V)



NOTE: HP Z820 Workstation configurations in which the power load is over 900W and the power source is between 90V and 115V require special power consumption and cooling considerations. Refer to the *Site Preparation Guide* at http://www.hp.com/support/workstation_manuals.

	Z220 SFF	Z220 CMT	Z420		Z620	Z820	
Power supply	240 W 90% efficient	400 W 90% efficient	400 W 90% efficient	600 W 90% efficient	800 W 90% efficient	850 W 88% efficient	1125 W 90% efficient *
Operating voltage range	90–264 VAC	90–269 VAC	90–269 VAC	90–269 VAC	90–269 VAC	90–269 VAC	90–269 VAC
Rated voltage range	100–240 VAC	100–240 VAC	100–240 VAC	100–240 VAC	100–240 VAC	100–127 VAC 200–240 VAC	100 VAC 115 VAC 200–240 VAC
Rated line frequency	50–60 Hz	50–60 Hz	50–60 Hz	50–60 Hz	50–60 Hz	50–60 Hz	50–60 Hz
Operating line frequency range	47–63 Hz	47–66 Hz	47–66 Hz	47–66 Hz	47–66 Hz	47–66 Hz	47–66 Hz
Rated input current	4A @ 100–240 VAC	5.5A @ 100–240 VAC	5.5A @ 100–240 VAC	8A @ 100–240 VAC	9.7A @ 100–240 VAC	11A @ 100–127 VAC 5.5A @ 200–240 VAC	12A @ 100VAC 12A @ 115–127 VAC 10A @ 200–240 VAC
Heat dissipation, typical (configuration and software dependent)	601.2 btu/hr (151.5 kcal/hr)	630.2 btu/hr (158.8 kcal/hr)	910 btu/hr (229 kcal/hr)	1365 btu/hr (344 kcal/hr)	1972 btu/hr (497 kcal/hr)	2142 btu/hr (540 kcal/hr)	2773 btu/hr (699 kcal/hr)
Heat dissipation, maximum (configuration and software dependent)	646.6 btu/hr (163.0 kcal/hr)	1569 btu/hr (395 kcal/hr)	1569 btu/hr (395 kcal/hr)	2354 btu/hr (593.2 kcal/hr)	3139 btu/hr (791 kcal/hr)	Max: 3335 btu/hr (840 kcal/hr)	Max1: 3878 btu/hr (977 kcal/hr) Max2: 5002 btu/hr (1260 kcal/hr) Max3: 5689 btu/hr (1433 kcal/hr)

	Z220 SFF	Z220 CMT	Z420		Z620	Z820	
Power supply fan <i>All fans are variable speed</i>	One fan, 92mm x 25mm	One fan, 92mm x 25mm	One fan, 92mm x 25mm	One fan, 92mm x 25mm	One fan, 92mm x 25mm	Two fans, 80mm x 25mm	Two fans, 80mm x 25mm
Built-in Self Test LED	No	Yes	Yes	Yes	Yes	Yes	Yes
Power consumption in sleep mode (as defined by ENERGY STAR)	<3 W	<4 W	<10 W	<10 W	<15 W	<15 W	<35 W

*The 1125 W power supply can also supply 1450 W of output power when the input voltage is greater than 180V. If the input voltage is less than 180V, but greater than 105V for any reason, the maximum power that can be drawn is 1275 W.

Power consumption and heat dissipation

Power consumption and heat dissipation specifications are available for multiple configurations. To review available specifications, see <http://www.hp.com/go/quickspecs>.

To reach zero power consumption, unplug the workstation from the power outlet or use a power strip with an on/off switch. For additional information about power-saving features, see the operating system installation instructions.

This product is in compliance with U.S. Executive Order 13221.

Resetting the power supply

If an overload triggers the power supply overload protection, power is immediately disconnected.

To reset the power supply:

1. Disconnect the power cord from the workstation.
2. Determine what caused the overload and fix the problem. For troubleshooting information, see [Diagnostics and troubleshooting on page 112](#).
3. Reconnect the power cord and restart the workstation.

When you power off the workstation through the operating system, power consumption falls below what is considered low power consumption but does not reach zero. This low power consumption feature extends the life of the power supply.

System board

If you replace the system board:

- Make a note of the cable connections before disconnecting them from the system board.
- Follow good cable management practices. See [Cable management on page 78](#).

The following tables show system cabling for the workstations.

System cabling

HP Z220 SFF Workstation system cabling

See [HP Z220 SFF Workstation components on page 1](#) to determine the location of system board connectors.

Cable	To	Cable designator on system board
PSU cable	PCA (Main power)	P1 (White)
PSU cable	PCA (PWR COMM)	P2 (White)
SATA power cable	PCA (CPU power)	P3 (White)
SATA power cable	HDD/ODD	P160 (Black)
SATA power cable	First HDD	D4
SATA power cable	First ODD	D6
Speaker	PCA	P6 (White)
Cooler fan cable	PCA	P9 (Brown)
Front audio cable	PCA	P23 (Blue)
LED/Power button cable	PCA	P5 (Black)
Front USB 2.0 cable-1	PCA	P24 (Yellow)
Front USB 2.0 cable-2	PCA	P25 (Green)
Serial cable	PCA	P52
Chassis solenoid lock	PCA	P124
SATA cable	First HDD	P60 (Blue)
SATA cable	Second HDD	P61 (Blue)
SATA cable	First ODD	P62 (Black)
SATA power cable	First HDD	D4
SATA power cable	Second HDD	D5
SATA power cable	First ODD	D6
eSATA bracket cable (optional)	First External SATA device	P64 (black)

HP Z220 CMT Workstation system cabling

See [HP Z220 CMT Workstation system board component on page 12](#) to determine the location of system board connectors.

Cable	To	Cable designator on system board
PSU cable	PCA (Main Power)	P1 (White)
PSU cable	PCA (CPU Power)	P3 (White)
PSU cable	First hard drive (Bay 6)	P8 (Black)
PSU cable	Second hard drive (Bay 5)	P9 (Black)
PSU cable	Third hard drive (Bay 4)	P10 (Black)
PSU cable	First optical drive (Bay 1)	P12 (Black)
PSU cable	Second optical drive (Bay 2)	P13 (Black)
PSU cable	Other drive (Bay 3)	P14 (White)
PSU cable	First graphics card	P6 (Black)
Speaker	PCA	P6 (White)
Cooler fan cable	PCA	P71 (White)
System fan cable	PCA	P8 (Brown)
Front fan cable (optional)	PCA	P9 (Brown)
Front audio cable	PCA	P28 (Black)
Front LED/Power button cable	PCA	P5 (Black)
Front USB 2.0/3.0 cable	PCA	P24 (Black)
Serial cable (optional)	PCA	P52 (Black)
Parallel cable (optional)	PCA	P126 (Black)
Hood sense	PCA	P125 (White)
Chassis solenoid lock	PCA	P124 (Black)
SATA cable	First HDD	P60 (Blue)
SATA cable	Second HDD	P61 (Blue)
SATA cable	Third HDD	P62 (Black)
SATA cable	First ODD	P63 (Black)
SATA cable	Second ODD	P64 (Black)
eSATA bracket cable (optional)	First external SATA device	P65 (Black)

HP Z420 Workstation system cabling

See [HP Z420 Workstation system board components on page 19](#) to determine the location of system board connectors.

Cable	To	Cable designator on system board
PSU cable	PCA (Main PWR)	P1
PSU cable	PCA (PWR MEM)	P2
PSU cable	First hard drive (Bay 6)	D1
PSU cable	Second hard drive (Bay 5)	D2
PSU cable	Third hard drive (Bay 4)	D3
PSU cable	First optical drive (Bay 1)	D4
PSU cable	Second optical drive (Bay 2)	D5
PSU cable	Other drive (Bay 3)	D6
PSU cable	First graphics card	G1 (600 W PSU only)
Speaker	PCA	P6 (SPKR) white
Cooler fan cable	PCA	P8 (CPU0 FAN) white
System fan cable	PCA	P95 (REAR FAN) white
Memory fan cable	PCAx	P92 (MEM FAN) white
Front audio cable *	PCA	P28 (FRONT AUD) black
Front 1394 cable	PCA	J12 1394, White
LED/Power button cable	PCA	P5 (PB/LED) black
Front USB 3.0 cable	PCA	P29 (USB 3.0) blue
Front USB 2.0 cable	PCA	P27 (FRONT USB 2.0) yellow
Media card reader	PCA	P24 (USB2) blue
Front fan cable	PCA	P9 (FRNTFAN) white
Second serial port	PCA	P52 (COM) black
Chassis solenoid lock	PCA	P124 (SOL_LOCK) black
Chassis Intrusion Sender	PCA	P125 (I_SENSE) white

* If an audio card is installed, connect the front audio cable to the audio card connector.

HP Z620 Workstation system cabling

See [HP Z620 Workstation system board components on page 26](#) to determine the location of system board connectors.

Cable	To	Cable/system board designator
PSU cable	PCA P1(PWR)	P1
PSU cable	PCA P2(PWRMEM)	P2
PSU cable	First hard drive	HDD BAY 0
PSU cable	Second hard drive	HDD BAY 1
PSU cable	Third hard drive	HDD BAY 2
PSU cable	First optical drive	D1
PSU cable	Second optical drive	D2
PSU cable	First graphic card	G1
PSU cable	Second graphic card	G2
Speaker	PCA	Pre-connected to FUI cable
CPU 0 HS fan cable	PCA	P8 (CPU 0 FAN) white
Rear fans cable	PCA	P11 (REAR FANS) white
MB memory fan cable	PCA	P91(MEM FAN) black blind-mate
Front fan cable	PCA	P9 (FRNTFAN) white
Front audio cable *	PCA	P28 (FRONT AUDIO) black
Front USB3.0 cable	PCA	P29 (FRNT USB3) blue
Front USB2.0 cable	PCA	P27 (FRNT USB2) yellow
Front UI cable	PCA	P5(PB/LED) black
Front 1394 cable	PCA	J12 (1394) white
Media card reader	PCA	P24 (I-USB2.0) blue
SAS card LED cable	PCA	P127 black
eSATA external connection	PCA	P64 (SATA4) black, P65 (SATA5) black
Hood lock cable	PCA	P124 (HOOD_LOCK) black
Hood sensor cable	PCA	P2 on FUI Cable, white
Serial option cable	PCA	P52 (COM) black
Second CPU PCA memory fan cable	Riser PCA	P9 (MEM_FAN) black blind-mate

* If an audio card is installed, connect the front audio cable to the audio card connector.

HP Z820 Workstation system cabling

See [HP Z820 Workstation system board components on page 33](#) to determine the location of system board connectors.

Cable	To	Cable/system board designator
PSU cable (C1)	PCA (P1)	P1
PSU cable (C3)	PCA (P2)	P2
PSU cable (C3)	PCA (P3)	P3
PSU cable (C3)	PCA (P4)	P4
PSU cable (C2)	Graphics card	G1
PSU cable (C2)	Graphics card	G2
PSU cable (C2)	Graphics card	G3
PSU cable (C1)	Hard drive cable	H1
PSU cable (C1)	Optical drive / hard drive	D1 (SATA power)
PSU cable (C1)	Optical drive / hard drive	D2 (SATA power)
PSU cable (C1)	Optical drive / hard drive	D3 (SATA power)
PSU cable (C1)	Optical drive	D4 (IDE power)
PSU cable (C1)	Optical drive	D5 (IDE power)
Front fan cable (top)	PCA	P94 (FRONT FAN 1) white
Front fan cable (bottom)	PCA	P93 (FRONT FAN 2) white
Rear fan cable	PCA	P8 (REAR FAN) white
Front audio cable *	PCA	P28 (FRONT AUD) black
Front 1394 cable	PCA	J13 (FRONT 1394) white
Front UI cable cable	PCA	P5 (FRONT PANEL) black
Front USB 2.0 cable	PCA	P27 (FRONT USB 2.0) yellow
Front USB 3.0 cable	PCA	P29 (FRONT USB 3.0) blue

* If an audio card is installed, connect the front audio cable to audio card connector.

4 Diagnostics and troubleshooting

This chapter describes the tools available for diagnosing and troubleshooting system issues.

- [Calling support](#)
- [Locating ID labels](#)
- [Locating warranty information](#)
- [Diagnosis guidelines](#)
- [Troubleshooting checklist](#)
- [HP troubleshooting resources and tools](#)
- [Troubleshooting scenarios and solutions](#)
- [Self-troubleshooting with HP Vision Diagnostics](#)
- [Self-troubleshooting with HP PC Hardware Diagnostics](#)
- [Diagnostic codes and errors](#)

Calling support

At times you might encounter an issue that requires support. When you call support:

- Have the computer readily accessible.
- Write down the computer serial numbers, product numbers, model names, and model numbers and have them in front of you.
- Note any applicable error messages.
- Note any add-on options.
- Note the operating system.
- Note any third-party hardware or software.
- Note the details of any blinking LEDs on the front of the computer (tower and desktop configurations) or on the side of the computer (all-in-one configurations).
- Note the applications you were using when you encountered the problem.

 **NOTE:** When calling in for service or support, you might be asked for the product number (example: PS988AV) of the computer. If the computer has a product number, it is generally located next to the 10- or 12-digit serial number of the computer.

 **NOTE:** On most models, the serial number and product number labels can be found on the top or side panel and at the rear of the computer (tower and desktop configurations) or on a pull-out card on the side of the display (all-in-one configurations).

For a listing of all worldwide support phone numbers, go to <http://www.hp.com/support>, select your region, and click **Connect with HP** in the upper-right corner.

Locating ID labels

To assist in troubleshooting, product, serial, and authentication numbers are available on each computer.

- All workstations have a serial number (unique for each workstation) and product number. Have these numbers available when you contact support.
- The Certificate of Authentication (COA) is used for systems with Windows 7 preinstalled.
- The Genuine Microsoft Label (GML) is used for systems with Windows 8 preinstalled.
- A service label shows the build ID and Feature Byte strings, which are needed for system board replacement.

In general, these labels can be found on the top, rear, or bottom of the chassis (tower and desktop configuration). Your computer might look different from the illustration.



Locating warranty information

To locate base warranty information, see <http://www.hp.com/support/warranty-lookuptool>.

To locate an existing Care Pack, see <http://www.hp.com/go/lookuptool>.

To extend a standard product warranty, visit <http://www.hp.com/hps/carepack>. HP Care Pack Services offer upgraded service levels to extend and expand a standard product warranty.

Diagnosis guidelines

If you encounter a problem with the computer, monitor, or software, the following sections provide a list of general suggestions that help you isolate and focus on the problem before taking further action.

Diagnosis at startup

- Verify that the computer and monitor are plugged into a working electrical outlet.
- Remove all CDs, or USB drive keys from your system before turning it on.
- Verify that the computer is turned on and the blue power light is blue (normal operation) and not red (error state).
- If you have installed an operating system other than the factory-installed operating system, check to be sure that it is supported on your system by visiting <http://www.hp.com/go/quickspecs>.
- Verify that the monitor is turned on and the green monitor light is on. Note that not all monitors are equipped with LED lights to indicate their functionality.
- Turn up the brightness and contrast controls of the monitor if the monitor is dim.

Diagnosis during operation

- Look for blinking LEDs on the side of the computer. The blinking lights are error codes that will help you diagnose the problem. Refer to the [Diagnostic LED and audible \(beep\) codes on page 145](#) section of this document for information on interpreting diagnostic lights and audible codes.
- Check all cables for loose or incorrect connections.
- Wake the computer by pressing any key on the keyboard or the power button. If the system remains in suspend mode, shut down the system by pressing and holding the power button for at least four seconds, then press the power button again to restart the system. If the system does not shut down, unplug the power cord, wait a few seconds, then plug it in again. If it does not restart, press the power button to start the computer.
- Reconfigure the computer after installing a non–plug and play expansion board or other option.
- Be sure that all required device drivers have been installed. For example, if you have connected a printer, you must install a printer driver.
- If you are working on a network, plug another computer with a different cable into the network connection. There might be a problem with the network plug or cable.
- If you recently added new hardware, remove the hardware and verify if the computer functions properly.
- If you recently installed new software, uninstall the software and verify if the computer functions properly.
- If the screen is blank, plug the monitor into a different video port on the computer if one is available. Alternatively, replace the monitor with a monitor that you know is working properly.
- Upgrade the BIOS. A new release of the BIOS might have been released that supports new features or fixes your problem.
- Press the [Caps Lock](#) key. If the [Caps Lock](#) LED toggles on or off, the keyboard is operating correctly.

Troubleshooting checklist

Before running diagnostic utilities, make sure that.

- The computer is connected to a working electrical outlet and powered on, and the power light is illuminated.
- The monitor (for tower or desktop configurations) is connected to a working electrical outlet and powered on, and the power light is illuminated.
- The monitor brightness and contrast are properly adjusted.
- The keyboard is operating correctly (press and hold any key and listen for a beep).
- All cables are properly connected.
- All necessary device drivers are installed
- All external media (such as optical disks or USB drive keys) are removed before startup.
- The latest version of BIOS, drivers, and software are installed.

HP troubleshooting resources and tools

This section provides information on the HP Help and Support Center, Online support, and Helpful Hints for troubleshooting.

HP Support Assistant

HP Support Assistant (Windows 7 systems only) helps you maintain workstation performance and resolve problems. HPSA provides automated updates, onboard diagnostics, product information, and guided assistance to help maintain optimum workstation performance. To access HPSA, click **Start > All Programs > HP Help and Support > HP Support Assistant**.



NOTE: HP Support Assistant is not available on Linux or Windows 8.

Online support

Online access and support resources include web-based troubleshooting tools, technical knowledge databases, driver and patch downloads, online communities, and product change notification services.

The following websites are also available to you:

- <http://www.hp.com>—Provides useful product information.
- http://www.hp.com/support/workstation_manuals—Provides the latest online documentation.
- <http://www.hp.com/go/workstationsupport>—Provides technical support information for workstations.
- <http://www.hp.com/support>—Provides a listing of the worldwide technical support phone numbers. Access the telephone numbers by visiting the website, then select your region, and click **Contact HP** in the upper-left corner.
- http://www.hp.com/support/workstation_swdrivers—Provides access to software and drivers for workstations.

Troubleshooting a problem

To help you troubleshoot problems with your system, HP provides the Business Support Center (BSC). The BSC is a portal to an extensive selection of online tools. To access BSC and troubleshoot a problem with the workstation, complete the following:

1. Visit <http://www.hp.com/go/workstationsupport>.
2. Under the **Business Support Center** menu on the left, select **Troubleshoot a problem**.
3. Under **Select your product** (center window), select **Workstations** (under **personal computing**).
4. Under **Select your product**, continue with selections as appropriate to the workstation series and model, and to the problem you are troubleshooting.

Instant Support and Active Chat

HP Instant Support is a set of web-based support tools that automate and speed up the resolution of desktop computing, tape storage, and printing problems.

Active Chat enables you to electronically submit a support ticket to HP over the web. When you submit a support ticket, Active Chat collects information about the computer and pass it to an online support specialist. The collection of information might take up to 30 seconds depending on the computer configuration. When you submit a support ticket, you receive a confirmation message containing your case ID, the support hours for your location, and the estimated time of response.

For more information about HP Instant Support and Active Chat and how to use them, go to <http://instantsupport.hp.com/>.

 **NOTE:** This feature is not available on Linux.

Customer Advisories, Customer and Security Bulletins, and Customer Notices

To find advisories, bulletins, and notices:

1. Visit <http://www.hp.com/go/workstationsupport>.
2. Select the desired product.
3. Under **Resources for <your selected product>**, select **See more...**
4. Under **Self-Help resources:** in the center of the window, choose the desired action and appropriate information in the scroll list to view the index.

Product Change Notifications

Product Change Notifications (PCNs) are proactive notifications for product changes occurring within a 30-60 day window of the effective date of the change in the manufacturing process. PCNs give customers advanced notice of changes to their product, such as an updated BIOS version that they may need to qualify prior to the change taking place. The latest PCNs are located at:

<http://www.hp.com/go/workstationsupport>.

Helpful hints

If you encounter a problem with the workstation, monitor, or software, the following general suggestions might help you isolate and focus on the problem before taking further action.

At startup

- Verify that the workstation and monitor are plugged into a working electrical outlet.
- Remove all optical discs and USB drive keys from the drives before powering on the workstation.
- Verify that the workstation is turned on and the power light is on.
- If you have installed an operating system other than the factory-installed operating system, check to be sure that it is supported on your system by visiting <http://www.hp.com/go/quickspecs>.
- Verify that the monitor is turned on and the green monitor light is on.
- Turn up the brightness and contrast controls of the monitor if the monitor is dim.
- If the workstation has multiple video sources and only a single monitor, the monitor must be connected to the source selected as the primary VGA adapter. During startup, the other monitor connectors are disabled; if the monitor is connected to one of these ports, it will not function after Power-on Self Test (POST). You can select the default VGA source in Computer Setup (F10).

During operation

- Look for blinking LEDs on the workstation. The blinking lights are error codes that will help you diagnose the problem. Refer to the *Diagnostic lights and audible (beep) codes* section of this document for information on interpreting diagnostic lights and audible codes.
- Press and hold any key. If the system beeps, then your keyboard is operating correctly.
- Check all cables for loose or incorrect connections.
- Wake the workstation by pressing any key on the keyboard or the power button. If the system remains in suspend mode, shut down the system by pressing and holding the power button for at least four seconds, then press the power button again to restart the system. If the system does not shut down, unplug the power cord, wait a few seconds, then plug it in again. If it does not restart, press the power button to start the workstation.
- Reconfigure the workstation after installing a non–plug and play expansion board or other option. Refer to the *Hardware installation problems* section of this document for instructions.
- Be sure that all required device drivers have been installed. For example, if you have connected a printer, you must install a printer driver.
- If you are working on a network, plug another workstation with a different cable into the network connection. There might be a problem with the network plug or cable.
- If you recently added new hardware, remove the hardware and verify if the workstation functions properly.
- If you recently installed new software, uninstall the software and verify if the workstation functions properly.
- If the monitor connected to a tower, desktop or all-in-one computer is blank:

- Plug the monitor into a different video port on the computer if one is available. Alternatively, replace the monitor with a monitor that you know is working properly.
- Verify that the computer *and monitor* are plugged into a working electrical outlet.
- Verify that the monitor is turned on and the green monitor light is on.
- Turn up the brightness and contrast controls of the monitor if the monitor is dim.
- If the internal display on an all-in-one computer is blank, open the computer and make sure the graphics card is properly installed.
- Upgrade the BIOS. A new release of the BIOS might have been released that supports new features or fixes your problem.

Customer Self-Repair program

Under the Customer Self-Repair program, you can order a replacement part and install the part without onsite HP technical assistance. Customer self-repair may be required for some components. See <http://www.hp.com/go/selfrepair> for information on the program.



NOTE: Some components are not eligible for customer self-repair and must be returned to HP for service. Call HP Support for further instructions before attempting to remove or repair these components.

Troubleshooting scenarios and solutions

This section presents troubleshooting scenarios and possible solutions for a Windows-based system.

Solving minor problems

Problem	Cause	Possible Solution
Workstation appears frozen and does not shut down when the power button is pressed.	Software control of the power switch is not functional.	<ol style="list-style-type: none">1. Press and hold the power button for at least four seconds until the computer shuts down.2. Disconnect the electrical plug from the outlet.3. Restart the computer.
Workstation seems to be frozen.	Program in use has stopped responding to commands.	<ol style="list-style-type: none">1. If possible, use the Windows Task Manager to isolate and terminate the offending process.2. Attempt the normal Windows shutdown procedure.3. Restart the computer using the power button.
Workstation date and time display is incorrect.	Real-time clock (RTC) battery might need replacement.	<ol style="list-style-type: none">1. Reset the date and time in the Control Panel.2. Replace the RTC battery.
Workstation appears to pause periodically.	Network driver is loaded and no network connection is established.	Establish a network connection, or use Computer Setup (F10) Utility or the Microsoft Windows Device Manager to disable the network controller.
Cursor does not move using the arrow keys on the keypad.	The Num Lock key might be on.	Press Num Lock . The Num Lock key can be disabled or enabled in Computer Setup (F10) Utility.
Poor performance is experienced.	Processor is hot.	<ol style="list-style-type: none">1. Verify that airflow to the computer is not blocked.2. Verify that chassis fans are connected and working properly. Some fans operate only when needed.3. Verify that the processor heatsink is installed properly.
	Hard drive is full.	Transfer data from the hard drive to create more space on the hard drive.
Workstation powered off automatically and the Power LED flashes red 2 times (once every second), followed by a 2-second pause, and then two simultaneous beeps sounded.	Processor thermal protection is activated. A fan might be blocked or not turning. OR The processor heatsink is not properly attached to the processor.	<ol style="list-style-type: none">1. Verify that the computer air vents are not blocked.2. Open the access panel and press the computer power button.3. Verify that the system fan is running.4. Verify that the processor heatsink fan spins. If the fan is not spinning, verify that the heatsink fan cable is plugged into the system board connector and that the heatsink is properly seated.5. Replace the processor heatsink.
System does not power on, and the LEDs on the front of the computer are not flashing.	System cannot power on.	Press and hold the power button for less than four seconds. If the hard drive LED turns green: <ol style="list-style-type: none">1. To find a faulty device, remove all devices one at a time:<ol style="list-style-type: none">a. Disconnect AC power to the computer.b. Remove a device.

Problem	Cause	Possible Solution
		<ul style="list-style-type: none"> c. Reconnect AC power and power on the computer.
		<ol style="list-style-type: none"> 2. Repeat this process until the faulty device is identified. Remove the graphics card last. Replace the faulty device. 3. If no faulty device is found, replace the system board.
		OR
		<ol style="list-style-type: none"> 1. Press and hold the power button for <i>less than</i> four seconds. If the hard drive LED does not illuminate: <ul style="list-style-type: none"> a. Verify that the computer is plugged into a working AC outlet. b. Verify that the power button harness is connected to the inline front panel I/O device assembly connector. 2. Verify that the power supply unit (PSU) cables are connected to the system board. 3. Verify power supply unit PSU functionality: <ul style="list-style-type: none"> a. Disconnect the AC power. b. HP Z820 Workstation only—Remove PSU. All other workstations, unplug cables connected to the system board. c. Reconnect AC power <ul style="list-style-type: none"> • If the PSU fan spins and the BIST LED illuminates, the PSU is good; replace the system board. • If the PSU fan does not spin or the LED does not illuminate, replace the PSU.

Solving hard drive problems

Problem	Cause	Solution
Hard drive error	Hard disk has bad sectors or has failed.	<p>Locate and block the usage of bad sectors. If necessary, reformat the hard disk.</p> <p>If the drive is detected by the BIOS, run DPS Self-test.</p>
Disk transaction problem	The directory structure is bad, or there is a problem with a file.	<ol style="list-style-type: none"> 1. Right-click Start, select Explore, and select a drive. 2. Select File > Properties > Tools. 3. Under Error-checking, select Check Now.
Drive not found (identified)	Improper cable connection	On computers with discrete data and power cables, ensure that the data and power cables are securely connected to the hard drive. (See the <i>Hard drive</i> section of this guide for connection details.)
	Improperly seated hard drive	<p>On systems with blind-mate drive connections, check for connector damage on the drive and in the chassis.</p> <p>Reseat the hard drive and its carrier in the chassis to ensure a proper connection. (See the <i>Hard drive</i> section of this guide for connection details.)</p>
	The system might not have automatically recognized a newly installed device.	<ol style="list-style-type: none"> 1. Run Computer Setup (F10) Utility. 2. If the system does not recognize the new device, verify that the device is listed in Computer Setup (F10) Utility. <ul style="list-style-type: none"> If it is listed, the probable cause is a driver problem. If it is not listed, the probable cause is a hardware problem. 3. If this drive is newly installed, enter Setup and try adding a POST delay under Advanced > Power-On.
	Drive responds slowly immediately after power-up.	Run Computer Setup (F10) utility and increase the POST Delay in Advanced > Power-On Options .
Non-system disk or NTLDR missing message	System is trying to start from nonbootable media.	Remove the optical disc or USB drive.
	System is trying to start from a damaged hard drive.	<ol style="list-style-type: none"> 1. Insert a bootable system optical disc or USB drive and restart the computer. 2. If the hard drive is still inaccessible and MBR Security is enabled, try restoring the previously saved MBR image by entering Setup and selecting Security > Restore Master Boot Record.
	System files missing or not properly installed.	<ol style="list-style-type: none"> 1. Insert a bootable system optical disc or USB drive and restart. 2. Verify that the hard drive is partitioned and formatted. 3. Install the system files for the appropriate operating system, if necessary.
	Hard drive boot disabled in Computer Setup.	Run Computer Setup (F10) Utility and enable the hard drive entry in the Storage > Boot Order list.
Workstation will not start.	Hard drive is damaged.	Replace the hard drive.

Solving display problems

These suggestions apply to monitors connected to desktop and tower configurations, and to external monitors connected to all-in-one configurations.

Problem	Cause	Solution
Blank screen (no video).	The cable connections are not correct.	Verify the cable connections from the monitor to the computer and to a working electrical outlet.
	The monitor is off.	Turn the monitor on (LED is on). You might need to refer to the monitor manual for an explanation of LED signals.
	Screen blanking utility installed or energy saver features enabled.	Press a key or the mouse button and, if set, enter your password.
	System ROM is bad; system is running in FailSafe Boot Block mode (indicated by 8 beeps).	Reflash the ROM using a SoftPaq.
	Fixed-sync monitor does not sync at the resolution specified.	Verify that the monitor can accept the same horizontal scan rate as the resolution specified.
	Computer is in Hibernate mode.	Press the power button to resume from Hibernate mode.
	Workstation monitor settings are not compatible with the monitor.	<ol style="list-style-type: none"> 1. When you see Press F8 in the bottom-right corner of the screen, restart the computer and press F8 during startup. 2. Using the keyboard arrow keys, select Enable VGA Mode and then press Enter. 3. For Windows, double-click the Display icon in the Control Panel and then select the Settings tab. 4. Use the sliding control to reset the resolution.
The display works properly during the POST but goes blank when the operating system starts.	The display settings in the operating system are incompatible with your graphics card and monitor.	<ol style="list-style-type: none"> 1. For Windows, restart your computer in VGA mode. 2. After the operating system starts, change the display settings to match those supported by your graphics card and monitor. 3. Refer to your operating system and graphics card documentation for information about changing display settings.
Power LED flashes red 6 times (once every second), followed by a two-second pause, and then the computer beeps 6 times.	Pre-video graphics error.	<p>For systems with a graphics card:</p> <ol style="list-style-type: none"> 1. Reseat the graphics card. 2. If the card requires external power, make sure the power cable is properly connected. 3. Replace the graphics card. 4. Replace the system board. <p>For systems with no graphics card installed, the CPU may have no integrated graphics capability.</p>
Monitor does not function when used with Energy Saver features.	Monitor without Energy Saver capabilities is being used with	Disable the monitor Energy Saver feature.

Problem	Cause	Solution
	Energy Saver features enabled.	
Dim characters	The brightness and contrast controls are not set properly.	Adjust the monitor brightness and contrast controls.
	Cables are not properly connected.	Verify that the graphics cable is connected to the graphics card and the monitor.
Blurry video or requested resolution cannot be set.	If the graphics controller was upgraded, the correct video drivers might not be loaded.	Install the video drivers included in the upgrade kit, or download and install the latest drivers for your graphics card from http://welcome.hp.com/country/us/en/support.html .
	Monitor cannot display requested resolution.	Change the requested resolution.
The picture is broken up, rolls, jitters, or flashes.	The monitor connections might be faulty, or the monitor might be incorrectly adjusted.	<ol style="list-style-type: none"> 1. Be sure the monitor cable is securely connected to the computer. 2. In a multiple CRT monitor system, ensure that the monitors' electromagnetic fields are not interfering with each other. Move them apart if necessary. 3. Move fluorescent lights or fans that are too close to the CRT monitor.
	Monitor must be degaussed.	Degauss the monitor.
Vibrating or rattling noise coming from inside a CRT monitor when powered on.	Monitor degaussing coil has been activated.	None. It is normal for the degaussing coil to be activated when the monitor is powered on.
Clicking noise coming from inside a CRT monitor.	Electronic relays have been activated inside the monitor.	None. It is normal for some monitors to make a clicking noise when turned on and off, when going in and out of Standby mode, and when changing resolutions.
High pitched noise coming from inside a flat-panel monitor.	Brightness and contrast settings are too high.	Lower brightness and contrast settings.
Fuzzy focus; streaking, ghosting, or shadowing effects; horizontal scrolling lines; faint vertical bars; or unable to center the picture on the screen (flat-panel monitors using an analog VGA input connection only.)	Flat-panel monitor's internal digital conversion circuits might be unable to correctly interpret the output synchronization of the graphics card.	<ol style="list-style-type: none"> 1. Select the monitor's Auto-Adjustment option in the monitor's onscreen display menu. 2. Manually synchronize the Clock and Clock Phase onscreen display functions. 3. Download SoftPaq SP22333 to assist with the synchronization).
Some typed symbols do not appear correctly.	The font you are using does not support that symbol.	Use the Character Map to locate and select the appropriate symbol.
		Select Start>All Programs> Accessories>System Tools>Character Map . You can copy the symbol from the Character Map into a document.

Solving audio problems

Problem	Cause	Solution
Sound does not come out of the speaker or headphones.	Software volume control is turned down.	Double-click the Speaker icon on the taskbar and use the volume slider to adjust the volume.
	The external speakers are not turned on.	Turn on the external speakers.
	External speakers plugged into the wrong audio jack.	See your sound card documentation for proper speaker connection.
	Digital CD audio is not enabled.	Enable digital CD audio: <ol style="list-style-type: none"> From the Control Panel, select System. On the Hardware tab, select the Device Manager button. Right-click the CD/DVD device and select Properties. On the Properties tab, select Enable digital CD audio for this CD-ROM device.
	Headphones or devices connected to the line-out connector have muted the internal speaker.	Turn on and use headphones or external speakers, if connected, or disconnect headphones or external speakers.
	Volume is muted.	<ol style="list-style-type: none"> From the Control Panel, select Sound, Speech and Audio Devices, and then select Sounds and Audio Devices. Deselect the Mute checkbox.
Computer is in Standby mode.	Press the power button to resume from Standby mode.	
Noise or no sound comes out of the speakers or headphones.		<ol style="list-style-type: none"> If you are using digital speakers that have a stereo jack and you want the system to autoswitch to digital, use a stereo-to-mono adapter to engage the auto sense feature, or use multimedia device properties to switch the audio signal from analog to digital. If the headphones have a mono jack, use the multimedia device properties to switch the system to analog out. <p>NOTE: If you set digital as the Output Mode, the internal speaker and external analog speakers no longer output audio until you switch back to an auto sense or analog mode.</p> <p>If you set analog as the Output Mode, external digital speakers do not function until you change the output mode back to an auto-sense or digital mode.</p>
Sound occurs intermittently.	Processor resources are being used by other open applications.	Shut down all open processor-intensive applications.
Workstation appears to be locked up while recording audio.	The hard disk might be full.	<ol style="list-style-type: none"> Before recording, be sure there is enough free space on the hard disk. Try recording the audio file in a compressed format.

Solving printer problems

Problem	Cause	Solution
Printer does not print.	Printer is not turned on and online.	Turn the printer on and be sure it is online.
	The correct printer driver for the application is not installed.	<ol style="list-style-type: none">1. Install the correct printer driver for the application.2. Try printing using the MS-DOS command: DIR C:\> [printer port] Replace <i>printer port</i> with the address of the printer used. If the printer works, reload the printer driver.
	If you are on a network, you might not have made a connection to the printer.	Make the proper network connection to the printer.
	Printer might have failed.	Run printer self-test.
Printer does not turn on.	The cables might not be connected properly.	

Solving power supply problems

This section presents power supply troubleshooting scenarios.

Testing power supply

Before replacing the power supply unit (PSU), use the Built-In Self-Test (BIST) feature to learn if the power supply still works.

 **NOTE:** Not all PSUs have the BIST functionality. Refer to the *Rear panel components* section of this document to determine BIST availability for your workstation.

To test the power supply:

1. Unplug the AC power.

 **NOTE:** For the HP Z820 Workstation, you **must** remove the power supply from the chassis.

2. Unplug all power cables to the system boards.
3. Plug in AC power and verify the following:
 - If the green BIST LED on the rear of the workstation is illuminated **and** the fan is spinning, the PSU is functional.
 - If the green BIST LED is not illuminated **or** the fan is not spinning, replace the PSU.

See the *Rear panel components* section of this document to locate the BIST LED on your workstation.

Problem	Cause	Solution
PSU shuts down intermittently.	Power supply fault.	Replace the PSU.
Workstation powers off and the Power LED flashes red 2 times (once every second), followed by a two-second pause.	Processor thermal protection is activated. A fan might be blocked or not turning. OR The processor heatsink fan assembly is not properly attached to the processor.	<ol style="list-style-type: none">1. Ensure that the workstation air vents are not blocked.2. Open the access panel and press the workstation power button.3. Verify that the system fan is running.4. Verify that the processor heatsink fan spins. If the heatsink fan is not spinning, verify that the fan cable is plugged into the system board connector. Verify that the fan is properly seated.5. Replace the processor heatsink.
Power LED flashes red (once every 2 seconds).	Power failure (power supply is overloaded).	<ol style="list-style-type: none">1. Determine whether a device is causing the problem by performing the following:<ol style="list-style-type: none">a. Disconnect AC power.b. Remove all attached devices.c. Power on the workstation.If the system enters the POST, perform the following:<ol style="list-style-type: none">a. Power off the workstation.

Problem	Cause	Solution
		<ul style="list-style-type: none"> b. Replace one device at a time and repeat this procedure until a failure occurs. c. Replace the device causing the failure d. Continue adding devices one at a time to verify that all devices are functioning. <p>2. Verify power supply functionality.</p> <ul style="list-style-type: none"> a. Disconnect AC power. b. Remove the Z820 PSU from the chassis. c. Unplug all system board power cables for the Z220 CMT, Z420, and Z620. d. Plug in AC power. <ul style="list-style-type: none"> • If the PSU fan spins and the LED illuminates (see Testing power supply on page 129), the power supply is good. Replace the system board. • If the PSU fan does not spin or the LED does not illuminate (see Testing power supply on page 129), replace the power supply.

Self-troubleshooting with HP Vision Diagnostics

Hewlett-Packard Vision Diagnostics is a diagnostic tool that can be used by the end user or technical support personnel to view information about the hardware configuration of the computer and perform hardware troubleshooting on HP desktop and workstation systems. This diagnostic tool is used to troubleshoot hardware failures. Accessible by either CD or USB key, these diagnostics run outside the operating system and make it easy to isolate potential issues that may be related to the operating system and not to the hardware.

HP Vision Diagnostics benefits:

- Captures complete system configuration information that can be shared as an HTML file, including:
 - System serial number, product number and BIOS revision
 - Memory size and configuration
 - Processor information
 - Storage device information and configuration
 - Graphics, audio, and communications information and configuration
- Comprehensive list of diagnostic tests:
 - Highly configurable testing options: quick, complete, custom, interactive, non-interactive
 - Identifies specific failed memory DIMM
 - Tests video card memory
 - Launches DST SMART tests for both SATA and SAS drives
 - Many other tests and diagnostics
- Diagnostic Failure Code Output — A unique warranty code is generated for each failure and can be used to validate diagnostic use for a specific system.
- Easy to use — Interface is similar to previous field diagnostics, HP Insight Diagnostics.
- True End2End diagnostics — Same diagnostics modules used in factory.
- Easy to obtain:
 - Download from HP website.
 - Install on bootable USB key, CD or DVD.
 - Included with restore media.

Overview

HP Vision Diagnostics allows you to view information about the hardware configuration of the computer and perform hardware diagnostic tests on the subsystems of the computer. The utility simplifies the process of effectively identifying, diagnosing, and isolating hardware issues.

When started, HP Vision Diagnostics displays the **Survey** tab, which shows the current configuration of the computer. Other tabs provide additional information, including diagnostic test options and test results. The information in each tab can be saved as an HTML file and stored on an optical disc or USB flash drive.

Use HP Vision Diagnostics to determine if all the devices installed on the computer are recognized by the system and functioning properly. Running tests is optional but recommended after installing or connecting a new device.

Before placing a call to the Customer Support Center HP recommends you run the tests, then save and print the test results so that you have the reports available.

 **NOTE:** Third-party devices may not be detected by HP Vision Diagnostics.

Downloading and accessing HP Vision Diagnostics

Follow these steps to download the HP Vision Diagnostics utility from the HP website to a DVD or USB, and then use it to perform diagnostics on the computer:

1. Go to <http://www.hp.com>.
2. Click the **Support and Drivers** link.
3. Click the **Drivers and Software** link.
4. Enter your product number in the text box, and then press **Search**.
5. Select your operating system.
6. Under the operating system section, select **Diagnostic**.
7. Locate **HP Vision Diagnostics**. Click **Download** next to the most recent version appropriate for your target media (USB flash or ISO file for CD).
8. Copy the file to an optical disc or follow the instructions to install the diagnostics on a USB flash drive.
9. While the computer is on, insert the disc or flash drive.
10. Shut down the operating system and turn off the computer.
11. Turn on the computer. The system will boot into HP Vision Diagnostics.

 **NOTE:** If the system does not boot to the disc in the optical drive or to the USB flash drive, you might need to change the boot order. Use Computer Setup (F10) utility to change the boot order, or press **F9** to select the appropriate boot device.

12. At the boot menu, select either the **HP Vision Diagnostics** utility to test the various hardware components in the computer or the **HP Memory Test** utility to test memory only.
13. If running HP Vision Diagnostics, select the appropriate language and click **Continue**.
14. In the End User License Agreement page, select **Agree** if you agree with the terms. The HP Vision Diagnostics utility launches with the Survey tab displayed.

Accessing HP Vision Diagnostics on the computer

The following procedures describe how to access the HP Vision Diagnostics utilities that are included in the computer software.

Creating and using a bootable USB key

This section describes how to use a USB key to access the HP Vision Diagnostics.

 **NOTE:** Using a USB key is the most convenient method to access the HP Vision Diagnostics. It is faster than using a CD, and it accommodates both Memory and Vision diagnostics.

The HP Memory Test is a comprehensive memory diagnostic utility that is run as a stand-alone application, outside of HP Vision Diagnostics. If the computer is booted from a CD, a separate boot CD will be required to use the memory diagnostic.

1. In the C:\VisionDiagnostics\ directory, double-click on VisionDiagUSB.exe. A setup menu appears.
2. Follow the setup prompts to create a bootable ISO image of the diagnostic utilities on a USB key.
3. Turn off the computer and restart it with the USB key installed. The computer will boot to the USB key and initiate the HP Vision Diagnostics utility.
4. Follow the HP Vision Diagnostic prompts to troubleshoot the computer.

Creating and using a bootable DVD

This section describes how to use a DVD to access the HP Vision Diagnostics.

1. In the C:\VisionDiagnostics\ directory, double-click on the VisionDiagISO.exe file. A setup menu appears.
2. Follow the setup prompts to create a bootable ISO image of the diagnostic utilities on a DVD.
3. Enable the computer to boot from DVD.
4. Turn off the computer and restart it with the DVD installed in the optical drive. The computer will boot to the DVD and initiate the HP Vision Diagnostics utility.
5. Follow the HP Vision Diagnostic prompts to troubleshoot the computer.

Using the HP Memory Test utility

This section describes how to access the HP Memory Test utility.

 **NOTE:** The HP Memory Test is a comprehensive memory diagnostic utility that is run as a stand-alone application, outside of HP Vision Diagnostics.

If the computer is booted from a CD, a separate boot CD will be required to use the memory diagnostic. Hence, HP recommends that a USB key be used to boot the diagnostic utilities. It is faster than using a CD, and it accommodates both Memory and Vision diagnostics.

1. In the C:\VisionDiagnostics\ directory, double-click on the MemoryDiagISO.exe file. A setup menu appears.
2. Follow the setup prompts to create a bootable ISO image of the memory diagnostic utility on a DVD.
3. Turn off the computer and restart it with the DVD installed in the optical drive. The computer will boot to the DVD and initiate the memory diagnostic utility.
4. Follow the diagnostic prompts to troubleshoot computer memory.

User interface

The HP Vision Diagnostics application provides six major functions, accessible through tabs:

- **Survey** — Current system hardware information
- **Test** — List of all diagnostics available for the system; tests are started here
- **Status** — Progress and status of currently running diagnostics
- **History** — Past diagnostics runs and status
- **Errors** — Past diagnostics failures
- **Help** — User help about HP Vision Diagnostics

Common operations include:

- **Exit Diagnostics** button — Closes HP Vision Diagnostic application and reboots the system; any running test is aborted.
- **Reload** button — If available, rescans your system hardware and reloads the diagnostics without the need to restart the system.
- **Save** button — If available, saves your system survey, test history or error data as an HTML file to removable media.

Survey tab

The Survey tab shows your system hardware information, organized into eleven Categories (for example *Processors*) and device instances (for example *Processor 1*).

You can control the amount of information displayed by selecting a combination of **View Level** and **Category**.

The **View Levels** include:

- **Overview** (default) — High-level summary of the system hardware
- **Summary** — Limited configuration data for each specific category
- **Advanced** — More technical and low-level data for the computer-savvy user

The **Categories Levels** include:

- **All** — All categories
- **Architecture** — System architecture information such as high-level PCI devices, low-level SMBIOS, CMOS, and PCI configuration space data
- **Audio** — All embedded and add-on audio devices
- **Asset Control** — Asset control related information such as product name, serial number, asset tag, and universal unique ID information
- **Communication** — Communication devices such as serial, parallel, USB, network, IEEE-1394a, modem, and Bluetooth ports and devices
- **Graphics** — All embedded and add-on video cards
- **Input Devices** — User input devices such as all connected mice and keyboards
- **Memory** — System memory information
- **Miscellaneous** — Any device or data that doesn't belong to any other category
- **Processors** — System processors
- **Storage** — Mass storage devices such as floppy drives, optical drives, SATA, SAS hard disk drives and controllers, as well as any RAID arrays
- **System** — Information about system board devices such as fans and cables

Test tab

The Test tab lists all available diagnostics. The lists have been tailored according to your system configuration. Individual test may be selected or deselected.

Tests have three modes:

- **Quick** — Test runs quickly while covering all hardware. Test parameters cannot be modified.
- **Complete** — Includes all available tests and may take a long time to complete. Test parameters cannot be modified.
- **Custom** — Includes all available tests and may take a long time to complete. Test parameters may be modified to fit specific needs. For advanced users only!

By default, the three test modes do not display prompts and require no interaction. Any errors are displayed when testing is complete.

However, for each test type, you may also optionally add interactive tests by clicking the **Include interactive tests** box under **Test mode**. Selecting interactive tests provides the maximum control over the testing process. The diagnostic software will prompt you for input during tests.



NOTE: Memory can not be tested from within the HP Vision Diagnostics application. To test the memory in your computer, exit HP Vision Diagnostic, boot to either the CD or USB flash drive and select **HP Memory Test** from the boot menu.

The **Duration of Test** options control the duration of the test sequence:

- **Number of loops** — Test runs specified number of times (default is 1).
- **Total test time (hours:minutes)** — Test runs for a specified amount of time; some tests might not run if the specified time is not long enough to run all tests.
- **Stop at first error** — Test stops as soon as one error is encountered.

Test Controls provide additional functions:

- **Select All, Unselect All** — Select/unselect all tests in test selection tree
- **Expand, Collapse** — Expand/collapse test selection tree
- **Start Test** — Starts executing selected tests and switches to the Status tab to display test execution and status



WARNING! Once started, do not reboot or power off your computer until all the tests have been completed.

To begin testing:

1. Select the **Test** tab.
2. Select the type of tests you want to run: **Quick**, **Complete**, or **Custom**.
3. Include optional interactive tests by selecting **Include interactive tests**.
4. Choose how you want the test to be executed, either **Number of Loops** or **Total Test Time**. When choosing to run the test over a specified number of loops, enter the number of loops to perform. If you want the diagnostic test for a specified time period, enter the amount of time in minutes.

5. Click the **Start Test** button. The **Status** tab, which allows you to monitor the progress of the tests, automatically displays during the testing process. When the tests are complete, the Status tab shows whether the devices passed or failed.
6. If errors are found, go to the **Errors** tab to view detailed information and recommended actions.

Status tab

The color-coded Status tab displays the overall progress and status of the test scenario and of each test.

The states and colors are:

- **Waiting** (black) — No test is running.
- **Running** (blue) — At least one test is currently running.
- **Passed** (green) — All tests have run successfully, meaning that no hardware error or defect was detected.
- **Failed** (red) — The tests have detected at least one error with your system.
- **Canceled** (orange) — The test scenario has been explicitly canceled, in which case no pass or fail conclusion can be drawn.

The available data is:

- **Current Loop** — Current execution loop out of total number of loops specified in the Test panel
- **Test Time** — Total time elapsed since the beginning of the test execution
- **Test Complete** — Number of tests successfully completed out of the total number of test to execute
- **Cancel** button — Immediately terminates all currently running tests

History tab

The History tab shows the history of the past test executions.

The History Log displays all tests that have been executed, the number of times of execution, the number of times failed, the date each test was executed, and the time it took to complete each test. The **Clear History** button will clear the contents of the History Log.

The contents of the History Log may be saved as a HTML file to either floppy or USB flash drive by clicking the **Save** button.

Errors tab

The Errors tab displays detailed information about any errors found, as well as any recommended actions.

The Error Log displays the tests for devices that have failed during the diagnostic testing and includes the following information:

- Device — Device tested
- Test — Type of test run
- Times Failed — Number of times the device has failed a test
- Defect Code — Numerical code for the failure (error codes are defined in the Help tab)
- Description — Error the diagnostic test found
- Reason — Likely cause of the error
- Recommended Repair — Recommended action that should be performed to resolve the failed hardware
- Warranty ID — A unique error code associated with the specific error on your computer; be prepared to provide it when contacting the HP Support Center for assistance with a hardware failure.
- Clear Errors — Clears the contents of the Error Log

Click the **Save** button to save the Error Log as an HTML file to removable media.

Help tab

The Help tab contains a Vision Help section and a Test Components section. This tab includes search and index features. You may also review the HP End User License Agreement (EULA), as well as the HP Vision Diagnostic application version information on this tab.

The Help sections are:

- **Vision Help** — Help on the major functions of HP Vision Diagnostics
- **Test components** — A description of each test, as well as the parameters that may be adjusted when running in Custom test mode
- **Defect codes** — Descriptions of the numerical error codes that appear in the Errors tab
- **Memory test tab** — Information on the HP Memory Test application that can be launched from the boot menu
- **HP Support** — How to obtain support from HP

Saving and printing information in HP Vision Diagnostics

You can save the information displayed in the HP Vision Diagnostics Survey, History and Errors tabs to removable media. You cannot save to the hard drive. The system automatically creates an HTML file that has the same appearance as the information displayed on the screen.

1. Insert removable media.
2. Click **Save** in the bottom on any of the **Survey**, **History** or **Errors** tabs. The three log files are saved regardless of where the **Save** button is clicked.
3. Select the removable media drive and click **Save**.



NOTE: Do not remove the media until a message indicates the files have been written.

4. Print the desired information HTML file.



NOTE: To exit HP Vision Diagnostics, click **Exit Diagnostics** at the bottom of the screen. Be sure to remove the removable media.

Self-troubleshooting with HP PC Hardware Diagnostics

HP PC Hardware Diagnostics is a Unified Extensible Firmware Interface (UEFI) based diagnostic tool that can be used by the end user or technical support personnel to view information about the system configuration and to perform hardware troubleshooting. The diagnostic tool runs outside of the operating system to isolate hardware failures from issues that might be caused by the operating system or other software components.

HP PC Hardware Diagnostics:

- Easy to obtain:
 - Installed on original image of every system hard drive (HDD)
 - Core set of tests installed in the BIOS of every system
 - Download to a USB key drive
- Captures complete system configuration information, including:
 - System serial number, product ID number, asset tag, and model
 - Memory size and configuration
 - Processor information (including, type and speed)
 - Storage device information
 - HDD: Launches Drive Self Test (DST) SMART tests for SATA drives
 - Keyboard controller revision
 - Bundles of tests to perform a quick test or extensive test of the entire system
 - BIOS date and revision
- Diagnostic tests:
 - System tests (Start-up, Run-In and System Tune-Up)
 - Individual component tests (Hard Disk Test and Memory Tests)
- Diagnostic Failure Code Output — A unique, 24-digit Failure ID code is generated for each failure:
 - Randomly generated, unique each occurrence
 - Identifies the specific components that did not pass validation
 - Includes warranty information with information about the customer's service entitlement
 - Provides information about the model, serial number, test time stamp, and failure
 - Includes recommended actions with URL information on whom to contact
 - Generation of the failure code indicates a definite hardware failure – no additional troubleshooting is required
- Error Log — The tool automatically saves an error log on the device from which the test was run (either the hard drive or USB drive). This log is available for future access from the tool and includes the test that was run, date of the test, and Pass/Fail information including the Failure ID if one was generated.

Downloading HP PC Hardware Diagnostics

 **NOTE:** The most likely cause of the diagnostics file being unavailable on the hard drive is a hard drive fault, or a missing or corrupted HP_TOOLS partition. For example, some corporate customers reimaged the workstation with their own custom image, which can remove the HP_TOOLS partition. In this case, a SoftPaq is available from the HP website.

The HP UEFI Support Environment must be installed on and run from a FAT or FAT32 partition with a volume name of HP_TOOLS. The installer gives you the option to install to the HDD or a USB drive. If you install to the hard drive and the HP_TOOLS partition is not present, the installer prompts you to create the HP_TOOLS partition. If you install to a USB drive, the installer renames the partition on the USB drive to HP_TOOLS. If you use a custom image, you can create the HP_TOOLS partition manually with FAT32 and make the volume name HP_TOOLS.

Follow these steps to download the HP PC Hardware Diagnostics utility from the HP website to a USB key:

1. Navigate to <http://www.hp.com> and select **Support & Drivers**.
2. Select **Drivers & Software**.
3. Enter the product name: Z220 to search for the Z220 product media.
4. Select the specific model of HP Z220 Workstation.
5. Choose the software/driver language. English (International) is the default.
6. Select the appropriate operating system.
7. On the Quick jump to downloads by category list, click **Diagnostic**.
8. Next to HP UEFI Support Environment, click **Download** and save the file.
9. Double-click the downloaded file and follow the on-screen instructions to expand the contents of the SoftPaq onto a USB key drive.

 **CAUTION:** The HP_TOOLS partition is not protected and can therefore be deleted. For these reasons, HP recommends that you do not place additional data on the HP_TOOLS partition. Because the partition is not backed up, corruption or failure of the partition will result in loss of all data on the partition, plus loss of UEFI functionality. You can find more information on <http://www.hp.com/go/techcenter/startup>.

Accessing HP PC Hardware Diagnostics

The process to access the diagnostics tool is the same regardless of the location from which it is run. The user presses **ESC**, while the system boots. This brings up the BIOS menu, which include an option to run diagnostics (**F2**). Once selected, the BIOS searches for a diagnostic signature. The diagnostic tool runs from the first location where the file is found.

The system searches for the file in the follow sequence: USB device, hard drive (HDD), and BIOS.

If the system does not find the diagnostics on either a USB device or the hard drive, the system presents a core set diagnostics (memory and HDD) that are located in the BIOS. The BIOS version is only accessible if the USB or hard drive versions are not available.

User interface

The first screen to appear is the Main Menu, which includes:

- The current version of the diagnostics
- The URL at which you can find more documentation about the diagnostics

It also includes the following options:

- System Information— Includes complete system, memory, and HDD
- System Tests— Bundles of component tests to run in a sequence: Includes options for Quick and Extensive tests
- Component Tests— HDD, memory
- Error Log— Results of current and previous diagnostic tests
- Language— 34 languages are supported
- Exit button— Closes Diagnostic application and reboots the system
- Esc key—Stops a diagnostics test while it is running

Running HP PC Hardware Diagnostics

The System Information screen provides extensive system information, which is retrieved from the SMBIOS tables if they are available. Otherwise it is retrieved directly from the BIOS hardware.

System information

To display the system information, click **System Information** on the Main Menu.

System information includes:

- Memory information
 - Number of DIMMs installed
 - Device locator
 - Manufacturer
 - Serial number
 - Part number
 - Memory size
 - Memory speed
 - Memory type
- Hard drive information
 - Type
 - Model
 - Firmware version
 - Serial number
 - Capacity
 - LBA48 support
 - Self-Monitoring, Analysis, and Reporting Technology (SMART) (Enabled/Disabled)
 - Sector type

Hardware diagnostic tests

HP PC Hardware Diagnostics provides five sets of hardware diagnostic tests to validate the functionality of hardware components (including the CPU, memory, graphics, and system board) prior to booting the operating system.

If the operating system cannot load because of a hardware failure, the diagnostics can be used to determine which hardware component has failed.

In the case of system failure, the diagnostics generate a unique 24-digit Failure ID code to identify the specific components that did not pass validation.

Test	Function
Start-Up Test	Analyzes the main components to make sure they are functioning properly to start the computer, the processor (CPU), the memory modules, and the hard drive. It checks the SMART attributes of the hard drive and performs the built-in Self-Test.
Run-In Test	Repeats the Start-up Test and checks for intermittent problems that the start-up test does not detect. Use this test if the computer is having intermittent problems while running, that do not appear to be related to system startup.
System Tune-Up	Similar to the Start-Up Test, the System Tune-Up performs the Start-Up Test plus tests the video memory.
Hard Disk Test	<p>The Hard Disk Test allows the selection of the Quick Extensive Test or Extensive Test of user selected drives in the system. The user can select a single drive, or they can select all of the drives in the system to run concurrently. The tests consists of the following subtests:</p> <ul style="list-style-type: none">• Quick Test<ul style="list-style-type: none">◦ Hard Disk SMART Check◦ Hard Disk Short DST• Extensive Test<ul style="list-style-type: none">◦ Hard Disk SMART Check◦ Hard Disk Short DST◦ Hard Disk Optimized DST Check◦ Hard Disk Long DST
Memory Test	<p>Analyzes the physical condition of the memory modules and reports any faulty modules. If this test reports an error, the faulty memory module(s) should be replaced immediately.</p> <p>The Memory Test allows selection of the Quick Memory Test or Extensive Memory Test.</p> <p>The Quick Test is the same version run in the Start-Up Test, and takes around five minutes for 4GB of memory to complete.</p> <p>The Extensive Test runs a longer version of the Memory Test, which adds additional pattern and transfer types to make it a more comprehensive test of the memory. This test normally runs approximately eight minutes/GB. Test times varies depending on system architecture, processor speed, and amount of memory.</p>

Diagnostic codes and errors

This section presents information about diagnostic LED codes, LED color definitions, and POST error messages to help you troubleshoot problems.

Diagnostic LED and audible (beep) codes

This section describes the front panel LED error and operation codes as well as the audible codes that might occur before or during the POST.

Activity	Possible cause	Recommended action
Blue Power LED* on. No beeps.	Computer on.	
Blue Power LED* blinks every two seconds.* No beeps.	Computer in Sleep mode (S3-Suspend to RAM). Select models only.	
Blue Power LED* is off.* No beeps.	Computer in Hibernate mode (S4-Suspend to disk) or system is off (S5).	N/A
Blue Power LED* blinks three times*, once per second.* No beeps.	Computer in Sleep mode (S3-Suspend to RAM). Select models only.	
Blue Power LED* blinks four times*, once per second.* No beeps.	Computer in Hibernate mode (S4-Suspend to disk).	

*User-selectable. See [Computer Setup \(F10\) Utility menu on page 43](#) for details.

For the following LED activity and beeps, the beeps are heard through the chassis speaker. Blinks and beeps repeat for five cycles, after which, only the blinks continue to repeat.

Red Power LED blinks two times, once every second, followed by a two-second pause. Two beeps.	<p>CPU thermal protection activated by either of the following methods:</p> <ul style="list-style-type: none"> • A fan might be blocked or not turning. • The heatsink and fan assembly is not properly attached to the CPU. 	<p>CAUTION: Internal components might be powered even when the computer is off. To prevent damage, disconnect the computer power cord before you remove a component.</p> <ol style="list-style-type: none"> 1. Ensure that the computer air vents are not blocked and the cooling fan is running. 2. Open the access panel, press power button, and verify that the CPU fan is spinning. If the CPU fan is not spinning, make sure the fan cable is plugged into the computer board header. Ensure the fan is fully and properly seated or installed. 3. If fan is plugged in and seated properly, but is not spinning, the problem might be in the CPU fan. Contact HP for assistance. 4. Verify that the fan assembly is properly attached. If problems persist, there might be a problem with the CPU heatsink. Contact HP for assistance.
Red Power LED blinks three times, once every second, followed by a	CPU not installed (not an indicator of bad CPU).	<ol style="list-style-type: none"> 1. Verify that the CPU is present. 2. Reseat the CPU.

Activity	Possible cause	Recommended action
two-second pause. Three beeps.		
Red Power LED blinks four times, once every second, followed by a two-second pause. Four beeps.	Power failure (power supply is overloaded).	<p>CAUTION: Internal components might be powered even when the computer is off. To prevent damage, disconnect the computer power cord before you remove a component.</p> <ol style="list-style-type: none"> 1. Open the access panel and ensure that all power connections are secure on the system board. 2. Check if a device is causing the problem by removing all attached devices (such as hard, diskette, or optical disk drives, and expansion cards.) Power on the computer. If the system enters the POST, power off and replace one device at a time; repeat this procedure until failure occurs. Replace the device that is causing the failure. Continue adding devices one at a time to ensure all devices are functioning properly.
Red Power LED blinks five times, once every second, followed by a two-second pause. Five beeps.	Pre-video memory error.	<p>CAUTION: Internal components might be powered even when the computer is off. To prevent damage, disconnect the computer power cord before you remove a component.</p> <ol style="list-style-type: none"> 1. Reseat DIMMs. 2. Replace DIMMs one at a time to isolate faulty module. 3. Replace third-party memory with HP memory. 4. The problem might be on the system board. Contact HP for assistance.
Red Power LED blinks six times, once every second, followed by a two-second pause. Six beeps.	Pre-video graphics error.	<p>CAUTION: Internal components might be powered even when the computer is off. To prevent damage, disconnect the computer power cord before you remove a component.</p> <ol style="list-style-type: none"> 1. Reseat the graphics card. 2. Verify the graphics auxiliary power cable is connected (if applicable). 3. Confirm the graphics card is in the appropriate slot (PCIe x16). 4. The problem might be on the graphics card. Contact HP for assistance.
Red Power LED blinks seven times, once every second, followed by a two-second pause. Seven beeps.	System board failure (ROM detected failure prior to video).	<ol style="list-style-type: none"> 1. Clear CMOS. <p>NOTE: Refer to the <i>Maintenance and Service Guide</i> for the computer model for detailed information on clearing CMOS.</p> <ol style="list-style-type: none"> 2. The problem might be on the system board. Contact HP for assistance.
Red Power LED blinks eight times, once every second, followed by a two-second pause. Eight beeps.	Invalid ROM based on bad checksum.	<p>CAUTION: Internal components might be powered even when the computer is off. To prevent damage, disconnect the computer power cord before you remove a component.</p> <ol style="list-style-type: none"> 1. Clear CMOS. <p>NOTE: Refer to the <i>Maintenance and Service Guide</i> for the computer model for detailed information on clearing CMOS.</p> <ol style="list-style-type: none"> 2. Upgrade the ROM using SoftPaq, either from the hard disk drive, CD, diskette, or USB removable device (for example,

Activity	Possible cause	Recommended action
		<p>HP Drive Key). See the ROM Flash section of the <i>Maintenance and Service Guide</i> at http://www.hp.com/support/workstation_manuals. SoftPaq is a self-extracting executable, which contains instructions for its use, that enables you to upgrade the ROM. To download the Softpaq executable, visit http://www.hp.com/go/workstationsupport.</p> <ol style="list-style-type: none"> 3. The problem might be on the system board. Contact HP for assistance. 4.
<p>Red Power LED blinks nine times, once every second, followed by a two-second pause. Nine beeps.</p>	<p>System powers on but does not start.</p>	<ol style="list-style-type: none"> 1. The problem might be on the system board. Contact HP for assistance. 2. The problem might be in the CPU. Contact HP for assistance.
<p>System does not power-on and LEDs are not blinking. No beeps.</p>	<p>System unable to power on.</p>	<p>CAUTION: Internal components might be powered even when the computer is off. To prevent damage, disconnect the computer power cord before you remove a component.</p> <p>To resolve the problem, choose one of the following options:</p> <p>Press and hold the power button for less than four seconds. If the hard disk drive LED turns green, then:</p> <ol style="list-style-type: none"> 1. Remove the expansion cards one at a time and try holding the power button again for less than four seconds. 2. The problem might be on the system board. Contact HP for assistance. <p>Press and hold the power button for less than four seconds. If the hard disk drive LED does not turn on green then:</p> <ol style="list-style-type: none"> 1. Check that unit is plugged into a working AC outlet. 2. Open the access panel and check that the power button harness is properly connected to the system board. 3. Check that all power supply cables are properly connected to the system board. 4. Check the power supply functionality. <ol style="list-style-type: none"> a. Disconnect the AC power. b. HP Z820 Workstation only—Remove the power supply from the chassis. All other workstations, unplug cables connected to system board. c. Plug in AC power. <ul style="list-style-type: none"> • If the power supply fan spins and the BIST LED illuminates, the power supply is good; replace the system board. • If the power supply fan does not spin or the LED does not illuminate, replace the power supply.

* The BIOS option you select controls the blue LED function during these suspend modes.

LED color definitions

The following table describes what each LED light on the computer front panel signifies.

LED state	LED color	System status
Solid	Blue	System is on.
Flashing	Blue	System is in Standby.
Solid or flashing	Red	System has experienced an error. (See POST error messages on page 148.)
None	No light	System is in Hibernate, or is off.

POST error messages

The Power-On Self Test (POST) is a series of diagnostic tests that runs automatically when the computer is powered on.

Audible and visual messages occur before the operating system starts if the POST encounters a problem. POST checks the following items to ensure that the computer system is functioning properly:

- Keyboard
- DIMMs
- Diskette drives
- All mass storage devices
- CPUs
- Controllers
- Fans
- Temperature sensors
- Cables (front/rear panels, audio, and USB ports)

The table shown next describes the POST error messages.

Screen message	Probable cause	Recommended action
102—System Board Failure		Potential system board problem; contact HP Support.
110—Out of memory space for option ROMs	Option ROM for a device could not run because of memory constraints.	Run Computer Setup (F10) Utility to disable unneeded option ROMs, and to enable ACPI/USB Buffers at Top of Memory.
161—Real-Time Clock Power Loss		<ol style="list-style-type: none">1. Run Computer Setup (F10) utility and set default settings.2. Replace the CMOS battery.3. Replace the system board.
162—Systems Options Error		<ol style="list-style-type: none">1. Run Computer Setup (F10) utility and set default settings.2. Replace the CMOS battery.

Screen message	Probable cause	Recommended action
		3. Replace the system board.
163—Time and Date Not Set	<ul style="list-style-type: none"> Invalid time or date in configuration memory. RTC battery might need replacement. CMOS jumper might not be properly installed. 	<ol style="list-style-type: none"> Set the date and time from the Control Panel or in Computer Setup (F10) Utility (depending on the operating system). If the problem persists, replace the RTC battery.
164—Memory Size Error	Memory configuration is incorrect.	Confirm that the correct memory is installed in the system.
201—Memory Error	RAM failure.	<ol style="list-style-type: none"> Run Computer Setup (F10) utility or the Windows utilities. Be sure that memory modules are installed correctly. Verify the memory module type. Remove and replace memory modules one at a time to isolate faulty modules. Replace faulty memory modules. If the error persists after replacing memory modules, replace the system board.
214—DIMM Configuration Warning	DIMMs are not installed correctly (not paired correctly).	See the service label on the computer access panel for the correct memory configurations, and reseal the DIMMs accordingly.
301—Keyboard Error	Keyboard failure.	<ol style="list-style-type: none"> Reconnect the keyboard with the computer powered off. Connect a keyboard directly to the computer (instead of through a switch box). Be sure that none of the keys are pressed. Replace the keyboard.
303—Keyboard Controller Error	I/O board keyboard controller is defective or is not set properly.	<ol style="list-style-type: none"> Reconnect the keyboard with the computer powered off. Connect a keyboard directly to the computer (instead of through a switch box). Replace the system board.
304—Keyboard or System Unit Error	Keyboard failure.	<ol style="list-style-type: none"> Reconnect the keyboard with the computer powered off. Connect a keyboard directly to the computer (instead of through a switch box). Be sure that none of the keys are pressed. Replace keyboard. Replace system board.
510—Splash Screen image corrupted	Splash Screen image has errors.	Update system BIOS/UEFI.
511—CPU Fan not detected	Fan is not connected or is defective.	1. Reseat the fan cable.

Screen message	Probable cause	Recommended action
		<ol style="list-style-type: none"> 2. Reseat the fan. 3. Replace the fan.
512—Rear chassis fan not detected	Fan missing, disconnected, or defective.	<ol style="list-style-type: none"> 1. Reseat the fan cable. 2. Reseat the fan. 3. Replace the fan.
513—Front Chassis fan not detected	Front fan missing, disconnected, or defective.	<ol style="list-style-type: none"> 1. Reseat the fan cable. 2. Reseat the fan. 3. Replace the fan.
514—Power supply wattage insufficient for hardware configuration	Computer configuration requires more power than the power supply can provide	Reduce the computer power consumption.
515—Power supply fan not detected	Power supply fan is disconnected or defective.	<ol style="list-style-type: none"> 1. Reseat the power supply cables. 2. Replace the power supply.
517—Memory fan not detected	Memory fan missing, disconnected, or defective.	<ol style="list-style-type: none"> 1. Reseat the fan cable. 2. Reseat the fan. 3. Replace the fan.
518—PCI fan not detected	PCI fan missing, disconnected, or defective.	<ol style="list-style-type: none"> 1. Reseat the fan cable. 2. Reseat the fan. 3. Replace the fan.
519—Hard drive fan not detected	Hard drive fan missing, disconnected, or defective.	<ol style="list-style-type: none"> 1. Reseat the fan cable. 2. Reseat the fan. 3. Replace the fan.
520—Memory fan (2) not detected	Memory fan (2) missing, disconnected, or defective.	<ol style="list-style-type: none"> 1. Reseat the fan cable. 2. Reseat the fan. 3. Replace the fan.
521—Memory fan (3) not detected	Memory fan(3) missing, disconnected, or defective.	<ol style="list-style-type: none"> 1. Reseat the fan cable. 2. Reseat the fan. 3. Replace the fan.
522—Memory fan (4) not detected	Memory fan(4) missing, disconnected, or defective.	<ol style="list-style-type: none"> 1. Reseat the fan cable. 2. Reseat the fan. 3. Replace the fan.
523—CPU fan (2) not detected	CPU fan(2) missing, disconnected, or defective.	<ol style="list-style-type: none"> 1. Reseat the fan cable. 2. Reseat the fan. 3. Replace the fan.
524—Rear chassis fan(2) not detected	Rear chassis fan(2) missing, disconnected, or defective.	<ol style="list-style-type: none"> 1. Reseat the fan cable. 2. Reseat the fan. 3. Replace the fan.

Screen message	Probable cause	Recommended action
525—Front chassis fan(2) not detected	Front chassis fan(2) missing, disconnected, or defective.	<ol style="list-style-type: none"> 1. Reseat the fan cable. 2. Reseat the fan. 3. Replace the fan.
526—CPU Liquid Cooling pump not detected	Liquid cooling pump on CPU1 is not detected.	<ol style="list-style-type: none"> 1. Reseat the pump cable. 2. Replace the pump.
527—CPU Liquid Cooling pump (2) not detected	Liquid cooling pump on CPU2 is not detected.	<ol style="list-style-type: none"> 1. Reseat the pump cable. 2. Replace the pump.
528—CPU requires Liquid Cooling solution	Invalid system configuration.	<ol style="list-style-type: none"> 1. Remove incorrect processor and reinstall original processor. 2. Remove incorrect cooling solution and reinstall original liquid cooling solution.
529—Unsupported WiFi Device(s) Detected	An unsupported WiFi device has been installed into an internal slot.	Remove the unsupported device.
917—Front Audio Not Connected	Front Audio mechanism is missing or is not connected.	<ol style="list-style-type: none"> 1. Replace or reconnect the missing front audio mechanism to the system board. 2. Reseat or replace the missing mechanism cable.
918—Front USB Not Connected	Front USB mechanism is missing or is not connected.	<ol style="list-style-type: none"> 1. Replace or reconnect the missing Front USB mechanism to the system board. 2. Reseat or replace the missing mechanism cable.
921—Front USB Not Connected	Front USB mechanism is missing or is not connected.	<ol style="list-style-type: none"> 1. Replace or reconnect the missing Front USB mechanism to the system board. 2. Reseat or replace the missing mechanism cable.
922—Front USB 2 Not Connected	Front USB 2 mechanism is missing or is not connected.	<ol style="list-style-type: none"> 1. Replace or reconnect the missing Front USB 2 mechanism to the system board. 2. Reseat or replace the missing mechanism cable.
923—Fatal IRPP error.		Potential system problem; contact HP Support.
924—Fatal IIO error		Potential system problem; contact HP Support.
925—Fatal Misc. Error	A fatal miscellaneous chipset error is selected.	
927—Fatal error on DIMM in slot CPU X DIMM Y	Fatal multibit ECC error detected on the DIMM in the slot labeled DIMM Y (where Y is a number), as labeled on the system board.	Replace the DIMM in the identified slot.
928—Fatal error occurred in the designated slot.	Fatal error occurred in the designated slot.	Move the card to a different slot. If the problem persists, replace the card.
929—Fatal MCA Errorr	An MCA condition is detected on the system.	
939—Front USB 3.0 Not Connected	Front USB 3.0 mechanism is missing or is not connected.	<ol style="list-style-type: none"> 1. Replace or reconnect the missing Front USB 3.0 mechanism to the system board. 2. Reseat or replace the missing mechanism cable.
940—Front 1394 Not Connected	Front 1394 mechanism is missing or is not connected.	<ol style="list-style-type: none"> 1. Replace or reconnect the missing Front 1394 mechanism to the system board.

Screen message	Probable cause	Recommended action
		2. Reseat or replace the missing mechanism cable.
941—PCIe Device(s) installed in slots 3 or 4 with a single CPU	Invalid system configuration.	<ol style="list-style-type: none"> 1. Move the PCIe device from PCIe slots 3 and/or 4 to other PCIe slots. 2. Add a second processor using appropriate HP accessory kit.
942—Memory Train Error	A DIMM or DIMMs did not train correctly.	
1801—Microcode Update Error	Unknown or unsupported processor stepping.	The microcode update failed. If the processor stepping is supported, contact HP Support.
1802—Processor Not Supported	The system board does not support the processor.	Replace the processor with a compatible one.

5 Configuring password security and resetting CMOS

This chapter describes how to configure password security and to reset CMOS.

- [Preparing to configure passwords on page 153](#)
- [Resetting the password jumper on page 154](#)
- [Clearing and resetting the CMOS on page 155](#)

Preparing to configure passwords

Computer Setup (F10) Utility enables you to create setup and power-on passwords.

There are three possibilities for setting passwords:

- Define a setup password only. You will need the password to enter Computer Setup (F10) Utility, but you will not need a password to start the workstation.
- Define a power-on password only. This password lets you start the workstation or enter the setup utility.
- Define both. In this case, the setup password lets you start the workstation and enter the setup utility. The power-on password starts the workstation but does not let you enter the setup utility.

After you create both passwords, you can use the setup password in place of the power-on password as an override to log into the computer (a useful feature for a network administrator).

 **NOTE:** You can only clear the passwords with the password jumper. Clearing CMOS does not clear the passwords.

 **CAUTION:** Before pressing the Clear CMOS button, back up your computer CMOS settings.

Pressing the Clear CMOS button resets CMOS values to factory defaults and erases customized information, including asset numbers and special settings.

To back up the CMOS settings, run Computer Setup (F10) Utility and select **Save to Diskette** from the File menu.

Resetting the password jumper

Use the following procedure to disable the power-on or setup password features and clear the power-on and setup passwords.

⚠ WARNING! To reduce the risk of personal injury from electrical shock and hot surfaces, be sure to disconnect the power cord from the wall outlet and allow the internal system components to cool before touching.

⚠ CAUTION: When the computer is plugged in, the power supply has voltage applied to the system board, even when the computer is turned off. Failure to disconnect the power cord can result in damage to the system.

⚠ CAUTION: Static electricity can damage the electronic components of the computer or optional equipment. Before beginning these procedures, be sure that you are discharged of static electricity by briefly touching a grounded metal object.

1. Access the jumper:
 - a. Shut down the operating system, turn off the computer and external devices, and then disconnect the computer power cord and external devices from power outlets.
 - b. Disconnect any external devices.
 - c. Verify that the AC power cord is disconnected from the power outlet.
 - d. Open the workstation.
 - e. Locate the password header and jumper.

The password header is E49. The password jumper is blue so it can be easily identified.
2. Remove the jumper from pins 1 and 2. Do not lose the jumper.
3. Restart the computer:
 - a. Close the workstation.
 - b. Reconnect the AC power cord to the power outlet.
 - c. Turn on the computer and wait for the workstation to display the HP splash screen.
4. Repeat step 1.
5. Replace the jumper on pins 1 and 2.
6. Repeat step 3, except press the **F10** key during startup to access Computer Setup (F10) Utility.
7. Use the setup utility to create new passwords.

Clearing and resetting the CMOS

This section describes the steps necessary to successfully clear and reset the CMOS. The CMOS of the computer stores password information and information about the computer configuration.

Using the CMOS button to reset CMOS

To clear CMOS using the Clear CMOS button, use the following procedure:

 **WARNING!** To reduce the risk of personal injury from electrical shock and hot surfaces, disconnect the power cord from the wall outlet and allow the internal system components to cool before touching.

 **CAUTION:** When the computer is plugged in, the power supply has voltage applied to the system board, even when the computer is powered off. Failure to disconnect the power cord can result in damage to the system.

Static electricity can damage the electronic components of the computer or optional equipment. Before beginning these procedures, be sure that you are discharged of static electricity by briefly touching a grounded metal object.

1. Back up your computer CMOS settings run Computer Setup (F10) Utility, and select **File > Save to Disk**.

 **CAUTION:** Pressing the Clear CMOS button resets CMOS values to factory defaults and erases customized information, including asset numbers and special settings.

2. Shut down the operating system, power off the computer and external devices, and disconnect peripheral devices.
3. Disconnect the AC power cord from the power outlet.

 **NOTE:** The CMOS button does not clear CMOS if the power cord is connected.

4. Open the workstation.
5. Locate, press, and hold the CMOS button for five seconds.

For assistance locating the CMOS button and other system board components, see the system board layout in [HP Z820 Workstation system board components on page 33](#).

6. Close the workstation, reconnect external devices, connect the power cord and power on the workstation.
7. The system boots to an F1 prompt and displays a message that the date/time has changed and that system options have changed.
8. Press **F1**. The system shuts down for three seconds and then powers on again.
9. Use the F10 (Setup) Utility to reset the date and time.

Using Computer Setup (F10) Utility to reset CMOS

1. Access Computer Setup (F10) Utility menu.
2. When Computer Setup message appears in the lower-right corner of the screen, press **F10**, and then press **Enter** to bypass the title screen, if necessary.

If you do not press **F10** while the message is displayed, the computer must be rebooted to access this utility.

3. From Computer Setup (F10) Utility menu, select **File > Default Setup**.
This restores the settings that include boot sequence order and other factory settings. However, it does not force hardware rediscovery.
4. Choose **Restore Factory Settings as Default**, and then press **F10** to accept.
5. Select **File > Apply Defaults and Exit**, and then press **F10** to accept.
6. Reset the computer passwords and configuration information, such as the system date and time.



NOTE: This step does not clear the passwords.

A Linux technical notes

HP offers a variety of Linux solutions for HP workstation customers:

- HP certifies and supports Red Hat Enterprise Linux (RHEL) on HP workstations.
- HP certifies SUSE Linux Enterprise Desktop (SLED) on HP workstations.
- HP offers a SLED 11 preload on some Z Series Workstations.

For Linux setup and restore procedures, see the user guide for your workstation at http://www.hp.com/support/workstation_manuals.

- [System RAM](#)
- [Audio](#)
- [Network cards](#)
- [Hyper-Threading Technology](#)
- [NVIDIA Graphics Workstations](#)
- [AMD Graphics Workstations](#)

 **NOTE:** After you set up the operating system, make sure that the latest BIOS, drivers, and software updates are installed.

 **CAUTION:** Do not add optional hardware or third-party devices to the workstation until the operating system is successfully installed. Adding hardware might cause errors and prevent the operating system from installing correctly.

System RAM

HP supports different amounts of total RAM in various HP workstations, based on the number of hardware DIMM slots and the capabilities of the system. The total memory supported for each configuration is listed in the *Hardware Support Matrix for HP Linux Workstations* at http://www.hp.com/support/linux_hardware_matrix.

Audio

All HP workstations come with built-in audio hardware. The audio hardware is supported by the *Advanced Linux Sound Architecture* (ALSA) drivers included with all modern Linux distributions.

The audio hardware provides basic playback and recording features. The ability to simultaneously play audio from multiple sources, such as applications and CDs, is provided in the ALSA driver that provides audio mixing. The performance of software audio mixing and playback is greatly improved in ALSA version 1.0.13 and later.

After the driver is installed, the optional NVIDIA and AMD graphics cards that are supported in HP workstations also provide audio functionality over HDMI. The signal can be passed through the DisplayPort connector to a monitor with audio capabilities. The vendor driver must be installed. Such a configuration might present two audio hardware choices. If you do not hear sound through the speakers, one possible reason is that the graphics card (default) is selected for audio output instead of the DisplayPort. Check the audio settings (for example, **Sound** in gnome-control-center).

In some systems, embedded Intel HD graphics may also present a similar HDMI audio device that can be used through the DisplayPort interface. No proprietary driver is needed for this device, just a sufficiently recent kernel.

Network cards

All HP workstations include one or two integrated network interface controllers. Some support optional NICs. Most Linux distributions have drivers for these interfaces.

Hyper-Threading Technology

The Z Series Workstations support Hyper-Threading Technology (HTT), an Intel technology that improves processor performance by enabling the processor to simultaneously performing multiple tasks. The operating system treats an HTT-enabled processor as two virtual processors and shares the workload between them when possible. This feature can be used only if the operating system support multiple processors and is specifically optimized for HTT.

To enable HTT:

1. During startup, press **F10** to enter Computer Setup (F10) Utility.
2. Select **Advanced > Device Options**.
3. Set **Hyper-Threading** to **Enable**, and then press **F10** to exit the menu.
4. Select **File > Save Changes and Exit**.
5. Restart the system to enable HTT.



NOTE: On most recent Linux distributions (including RHEL 5, RHEL 6, SLED 11, and updates to those streams), the kernel automatically detects that HTT is enabled and works correctly.

NVIDIA Graphics Workstations

Some workstation configurations come with NVIDIA Quadro graphics hardware. HP recommends the use of NVIDIA drivers for best results on Linux systems.

HP provides recommended versions of the drivers with RPM-compatible installers for RHEL and SLED distributions. These are available from the HP Installer Kit for Linux and from workstation driver repositories on hp.com. When HP installers are used, their contents and documentation links are located in the `/opt/hp/nvidia` folder.

When installing Linux on a workstation that contains an NVIDIA card, administrators should select a VESA-compatible driver to avoid the instability that is experienced with some open-source versions of the Nouveau and DRM drivers.

Open-source versions of Nouveau drivers and NVIDIA drivers cannot coexist in the same runtime environment because they use the same hardware resources. If administrators create their own Linux environments using NVIDIA drivers but choose not to use HP-packaged versions, HP recommends that they manually append the following boot loader parameters to properly suppress the Nouveau driver at runtime (grub example below):

```
kernel /vmlinuz ... rdblacklist=nouveau nouveau.modeset=0
```

This action is applied by HP installers but must be applied/restored under other circumstances.

To customize display characteristics and resolutions when the computer is using an NVIDIA driver, execute the following command:

```
/usr/bin/nvidia-settings
```

To create and manipulate the `/etc/X11/xorg.conf` file, execute:

```
/usr/bin/nvidia-xconfig
```

AMD Graphics Workstations

Some workstation configurations include AMD graphics hardware. HP recommends use of AMD graphics drivers for best results on Linux systems.

HP also provides recommended versions of AMD graphics drivers with RPM-compatible installers for RHEL and SLED distributions. These are available from the HP Installer Kit for Linux and workstation driver support packages on hp.com.

The open source RADEON and RADEONHD drivers can conflict with the AMD graphics drivers by claiming the hardware early in the boot process. The AMD driver installation process usually blacklists conflicting drivers and turns off kernel mode-setting in the initial RAM image.

Administrator customization of the display characteristics and many other aspects of an AMD graphics driver environment is available through the following command, which starts the Catalyst Control Center:

```
/usr/bin/amdcccle
```

Some settings for AMD graphics, including reconfiguration of the `/etc/X11/xorg.conf` file, can be accomplished through the many options provided by the following command:

```
/usr/bin/aticonfig
```

Information can be found in these directories after the driver is installed:

```
/opt/hp/ati
```

```
/usr/share/ati
```

```
/usr/share/doc/fglrx
```

If the automatic init script attempts to rebuild the kernel module, the name of the log file is `/var/log/fglrx-build.log`.

B Configuring RAID devices

This appendix explains how to configure RAID arrays on your workstation.

- [RAID hard drive maximum and associated storage controller options](#)
- [Supported RAID configurations](#)
- [Configuring Intel SATA RAID](#)
- [Configuring RAID on an LSI 2308 or LSI 9212-4i controller](#)
- [Configuring RAID on an LSI 9260-8i MegaRAID controller](#)
- [Software RAID solution](#)

For additional information about RAID configuration, go to http://www.hp.com/support/RAID_FAQs.

RAID hard drive maximum and associated storage controller options

This section lists the maximum number of hard drives supported on HP workstations according to RAID configuration and storage controller options.

 **NOTE:** This section applies to internal workstation configurations that do not use add-in cards and external enclosures.

	Hard Drives				Storage Controllers				
	SATA		SAS		Onboard		Optional		
	8.5 mm (3.5 in)	6.3 mm (2.5 in)	8.5 mm (3.5 in)	6.3 mm (2.5 in)	RST	RSTe	LSI 2308	LSI 9212-4i	LSI 9260-8i
Z220 SFF	2	2	—	—	Yes	—	—	—	—
Z220 CMT	3	3	—	—	Yes	—	—	—	—
Z420	4	4	4	4	—	Yes	—	Yes	Yes
Z620	4	4	4	4	—	Yes	—	Yes	Yes
Z820	6	8	6	8	—	Yes	Yes	—	Yes

Supported RAID configurations

All workstation platforms have Intel controllers, as follows:

- LSI 2308 controllers — HP Z820 Workstations
- LSI 9212-4i controllers — HP Z420 and Z620 Workstations (optional)
- LSI 9260-8i controllers — HP Z420, Z620, and Z820 Workstations (optional)

The following RAID configurations are supported:

Configuration	Description	Controllers
RAID 0 Integrated striped disk array	<ul style="list-style-type: none"> • Requires a minimum of two drives. • Provides improved I/O performance. • Provides no fault tolerance. • Loses all data if any disk in the array fails. • Increases disk performance. 	<ul style="list-style-type: none"> • Intel with RSTe or RST • LSI 2308 • LSI 9212-4i • LSI 9260-8i
RAID 1 Mirrored disk array	<ul style="list-style-type: none"> • Supports a minimum of two drives.. • Provides 100% redundancy: all data from one drive is duplicated on a second drive. • Recovers from a single-drive failure. • Serves as a good entry-level redundant system. 	<ul style="list-style-type: none"> • Intel with RSTe or RST • LSI 2308 • LSI 9212-4i • LSI 9260-8i
RAID 5 Striped disk array with distributed parity	<ul style="list-style-type: none"> • Supports three or more drives. • Provides fault tolerance and I/O performance improvement, especially for write-biased applications. • Retains all data if a single drive fails but performance is compromised until the failed drive is replaced and the array rebuilt. 	<ul style="list-style-type: none"> • Intel with RSTe or RST • LSI 9260-8i
RAID 10 Striped and mirrored disk array	<ul style="list-style-type: none"> • Supports four or more drives. • Provides excellent. • Uses several drives to stripe data, then copies the striped drives to provide redundancy. • Offers high data transfer of striped arrays and provides increased data accessibility (reads). 	<ul style="list-style-type: none"> • Intel with RSTe or RST • LSI 2308 • LSI 9212-4i • LSI 9260-8i
RAID 1E Two-way mirroring	<ul style="list-style-type: none"> • Provides benefits comparable to RAID 10. • Requires an odd number of drives. • Delivers improved read performance. 	<ul style="list-style-type: none"> • LSI 2308 • LSI 9212-4i

Configuring Intel SATA RAID

This section describes how to use Intel® Rapid Storage Technology enterprise (Intel® RSTe) or Intel® Rapid Storage Technology (RST) to set up and manage SATA RAID volumes.



NOTE: These instructions apply to Windows-based systems. They also apply to Linux distributions that include the iscsi kernel driver support for the RSTe technology. This driver is included on recent releases of most upstream and enterprise distributions, and may be available for addition to some previous releases. If this driver is not available in the distribution, or is not applicable to the platform (e.g., the RST controller), the Software RAID solution is recommended.

You can create a SATA RAID array that contains up to the maximum number of internal SATA hard disk drives and eSATA drives (if you use an optional eSATA bulkhead cable) supported on your workstation.

Two or more hard drives must be attached to a controller (AHCI or SCU) for that controller's option ROM to run. If two or more drives are on each controller, a unique option ROM executes for each controller.

The Intel SATA AHCI option ROM and SCU option ROM configuration utilities run when you select **RAID+AHCI** for the SATA emulation mode.

Configuring system BIOS

To set up a RAID configuration, the emulation mode must be set to RAID+AHCI in Computer Setup (F10) Utility. This is the default setting. If the mode has been changed, follow these steps to reinstate it.

1. During startup, press **F10** to enter Computer Setup (F10) Utility. Use the arrow keys to navigate and select options.
2. Select a language from the list, and then press **Enter**.
3. Select **Storage > Storage Options**, then press **Enter**.
4. Select **SATA Emulation > RAID+AHCI**, then press **F10** to accept the new settings.
5. Select **Advanced > Power-On Options**, then press **Enter**.
6. Select **POST Messages > Enable**, and then press **F10** to accept the new settings.
7. Select **Advanced > Device Options**, then press **Enter**.
8. Select **SATA RAID Option ROM Download**, then press **Enter**.
9. Select **Enable**, then press **F10** to accept the new settings.
10. Select **File > Save Changes and Exit**, then press **Enter**.
11. Press **Enter** to accept the changes.

Configuring RAID with the Intel utility

Follow these steps to create RAID volumes.

 **NOTE:** The option ROM displays once for each controller. For example, if you have two drives on the AHCI controller and two on the SCU controller, then both option ROMs display. Following the prompt, select **Ctrl+I** to choose the controller.

1. Press **Ctrl+I** when prompted to enter the Intel Rapid Storage Technology enterprise utility (RSTe). Use the arrow keys and the space bar to navigate and select options.

 **NOTE:** If only one hard drive is attached, the utility does not open.

 **NOTE:** On the HP Z220 Workstation, the Intel Rapid Storage Technology utility (RST) is used.

2. Select **Create RAID Volume**, then press **Enter**.
3. Type the a name for the RAID volume in the Name field, then press **Tab**.
4. Select a level in the RAID Level field, then press **Tab**.
5. If three or more hard drives are installed, complete the following steps:
 - a. Press **Enter** to display the Select dialog box.
 - b. Select individual physical members of the volume.
 - c. Press **Enter** to exit the Select dialog box and to return to the Create Volume Menu dialog box.
6. If appropriate, select a size in the Stripe Size field, and then press **Tab**.
7. Enter the desired volume size in the Capacity field, and then press **Tab**.
8. Press **Enter** to initiate volume creation.
9. When the warning message appears, press **Y** to create the volume.
10. Select **5 > Exit**, then press **Enter**.
11. Press **Y** to confirm the exit.

Configuring RAID on an LSI 2308 or LSI 9212-4i controller

This section explains how to use the LSI Logic Configuration Utility to set up a SATA or SAS RAID array on the LSI 2308 or LSI 9212-4i controllers.



NOTE: These instructions apply to both Windows-based systems and Linux-based systems.

RAID 0 configuration

Follow these steps to configure an Integrated Striped (IS) volume with the BIOS-based configuration utility. The procedure assumes that the system has the required disk and disk controllers.

1. During startup, press **Ctrl-C** when prompted to start the LSI Logic Configuration Utility. Use the arrow keys and the space bar to navigate and select options.
2. Select an appropriate adapter, then press **Enter**.
3. Select **RAID Properties**, and then press **Enter**.
4. Select **Create IS Volume**, and then press **Enter**.
5. On the Create New Array screen, select the first disk for the IS volume. In the RAID Disk column for this disk, and then select **Yes**.

WARNING! If partitions have been defined on the selected disk, data on the disk will be lost when the striped volume is created.

6. To select additional drives for the striped volume (up to the maximum number allowed for the workstation), repeat step 5.
7. When all drives are selected, press **C** to create the array. Select **Save changes then exit this menu**, and then press **Enter**.
8. When the new array is created, the Adapter Properties screen appears. Press **Esc** twice, and then select **Exit**.

RAID 1 configuration

Follow these steps to configure an Integrated Mirroring (IM) volume with the BIOS-based configuration utility. The procedure assumes that the system has the required drives and drive controllers.

1. During BIOS startup, press **Ctrl-C** when prompted to start the LSI Logic Configuration Utility. Use the arrow keys and the space bar to navigate and select options.
2. Select an appropriate adapter, then press **Enter**.
3. Select **RAID Properties**, and then press **Enter**.
4. Select **Create IM Volume**, and then press **Enter**.
5. To configure a two-disk mirrored volume with an optional hot-spare disk:
 - a. On the Create New Array screen, select the primary disk for the IM volume (the disk with the data you want to mirror.)
 - b. On the RAID Disk column for this disk, and then select **Yes**. The value in the Array Disk column changes to Primary.

 **WARNING!** If partitions have been defined on the selected disk, data on the disk will be lost when the mirrored volume is created.

 - c. Select the secondary (mirrored) disk for the IM volume and set the Array Disk column value to **Yes**.
 - d. Press **Delete** to allow the data on the disk to be erased, or press any other key to deselect the disk.
6. When all drives are selected, press **C** to create the array.
7. Select **Save changes then exit this menu**, and then press **Enter**.
8. When the new array is created, the Adapter Properties screen appears. Press **Esc** twice, and then select **Exit**.

RAID 1E/10 configuration

Follow these steps to configure an Integrated Mirroring Extended (IME) volume. The procedure assumes the system has the required disk and disk controllers.



NOTE: If an odd number of drives is used, a RAID 1E array is created. If an even number of drives is used, a RAID 10 array is created.

1. During BIOS startup, press **Ctrl-C** when prompted to start the LSI Logic Configuration Utility. Use the arrow keys and the space bar to navigate and select options.
2. Select an appropriate adapter, and then press **Enter**.
3. Select **RAID Properties**, and then press **Enter**.
4. Select **Create IME Volume**, and then press **Enter**.
5. To configure a mirrored volume or an optional hot spare drive with up to the maximum number of drives allowed for the workstation, complete the following steps:
 - a. On the Create New Array screen, select the primary disk for the IME volume (the disk with the data you want to mirror.)
 - b. In the **RAID Disk** column for this disk, select **Yes**. The value in the Array Disk column changes to Primary.

WARNING! If partitions have been defined on the selected disk, data on the disk will be lost when the mirrored volume is created.

 - c. Select the next disk for the IME volume (mirrored) disk for the IM volume and set the Array Disk column value to **Yes**.
 - d. Press **Delete** to allow the data on the disk to be erased, or press any other key to deselect the disk.
6. Repeat step 5 to select up to the workstation-specific maximum number of drives for the IME volume, including of a hot spare.
7. After all drives are selected, press **C** to create the array.
8. Select **Save changes then exit this menu**, and then press **Enter**.
9. When the new array is created, the Adapter Properties screen appears. Press **Esc** twice, and then select **Exit**.

Configuring RAID on an LSI 9260-8i MegaRAID controller

This section explains how to use the LSI Logic Configuration Utility to set up SATA or SAS RAID arrays on the LSI 9260-8i MegaRAID controller.

 **NOTE:** These instructions apply to both Windows-based systems and Linux-based systems.

RAID 0

Follow these steps to configure a RAID 0 volume with the BIOS-based configuration utility. The procedure assumes that the system has the required disk and disk controllers.

 **NOTE:** For more information about the 9260-8i RAID controller, see the *MegaRAID SAS Software User Guide* at http://www.lsi.com/downloads/Public/MegaRAID%20Common%20Files/51530-00_RevE.pdf, particularly the “Introduction to RAID” and “WebBIOS Configuration Utility” sections.

1. Be sure the drives you want to configure are connected to the LSI 9260-8i MegaRAID controller.

 **NOTE:** For details, see *LSI MegaRAID SAS 9260-8i Card Installation* at <http://bizsupport1.austin.hp.com/bc/docs/support/SupportManual/c02027249/c02027249.pdf>.

2. During startup, press **Ctrl-H** to enter the LSI 9260-8i WebBios utility. Use the arrow keys and the space bar to navigate and select options.

3. Configure the array:

- a. In the left pane, select **Configuration Wizard**.
- b. Select **Add Configuration**, and then select **Next**.
- c. Select **Manual Configuration**, and then select **Next**.
- d. Select the drives to include in the RAID array, and then select **Add To Array**.
- e. Select **Accept DG**, and then select **Next**.
- f. Select **Add to SPAN**, and then select **Next**.

4. Select the desired options for your RAID array. Available options:

- RAID Level (available options depend on the number of disks in your RAID volume): RAID 0, RAID 1, RAID 5, RAID 6
- Strip Size: 8KB, 16KB, 32KB, 64KB, 128KB, 256KB, 512KB, 1MB
- Access Policy: RW (Read/Write), Read Only, Blocked
- Read Policy: Normal, Ahead
- Write Policy: Write Through, Always Write Back, Write Back with BBU
- IO Policy: Direct, Cached
- Drive Cache: No Change, Enable, Disable
- Disable BGI: No, Yes
- Select Size: Specify the size of the RAID array

5. Select **Next**.

6. A message warns you of the effect of your particular Write Policy setting:

- **Write Through:**The configuration might result in slower performance.
 - **Always Write Back:** The configuration results in optimal performance, but there is a risk of data loss in the event of power failure.
 - **Write Back with BBU:** If you have not installed BBU, write back is enabled only when the battery has a sufficient charge. During a learning cycle, the caching policy reverts to write-through until the learning cycle is complete.
7. Select **Yes** to accept the warning, and then select **Next**.
 8. Select **Accept**, and then select **Yes** to save the configuration.
 9. Select **Yes** to initialize the virtual drive you created.

Software RAID solution

This section summarizes software RAID considerations that are specific to the Linux environment, and provides links to additional configuration resources.

Software RAID considerations

The Linux kernel software RAID driver (called *md*, for *multiple device*) offers integrated software RAID without the need for additional hardware disk controllers or kernel patches. Unlike most hardware RAID solutions, software RAID can be used with all types of disk technologies, including SATA, SAS, SCSI, and solid-state drives. This software solution requires only minimal setup of the disks themselves.

However, when compared to hardware-based RAID, software RAID has disadvantages in managing the disks, breaking up data as necessary, and managing parity data. The CPU must assume some extra loading: disk-intensive workloads result in roughly double the CPU overhead (for example, from 15% to 30%). For most applications, this overhead is easily handled by excess headroom in the processors. But for some applications where disk and CPU performance are very well balanced and already near bottleneck levels, this additional CPU overhead can become troublesome.

Hardware RAID offers advantages because of its large hardware cache and the capability for better scheduling of operations in parallel. However, software RAID offers more flexibility for disk and disk controller setup. Additionally, hardware RAID requires that a failed RAID controller must be replaced with an identical model to avoid data loss, whereas software RAID imposes no such requirements.

Some software RAID schemes offer data protection through mirroring (copying the data to multiple disks in case one disk fails) or parity data (checksums that allow error detection and limited rebuilding of data in case of a failure). For all software RAID solutions on HP workstations, redundancy can be restored only after the system is shut down so that the failed drive can be replaced. This replacement requires only a minimum amount of work.

Performance considerations

Disk I/O bandwidth is typically limited by the system bus speeds, the disk controller, and the disks themselves. The balance of these hardware limitations, as affected by the software configuration, determines the location of the any bottleneck is in the system.

Several RAID levels offer improved performance relative to stand-alone disk performance. If disk throughput is restricted because of a single disk controller, RAID can probably do little to improve performance until another controller is added. Conversely, if raw disk performance is the bottleneck, a tuned software RAID solution can dramatically improve the throughput. The slower disk performance is, relative to the rest of the system, the better RAID performance will scale, because the slowest piece of the performance pipeline is being directly addressed by moving to RAID.

Configuring software RAID

See the following sites for additional information about configuring software RAID on Red Hat Enterprise Linux (RHEL) or SUSE Linux Enterprise Desktop (SLED):

- Red Hat Enterprise Linux 6—See the *Storage Administration Guide* at http://docs.redhat.com/docs/en-US/Red_Hat_Enterprise_Linux/6/html/Storage_Administration_Guide/index.html
- Red Hat Enterprise Linux 5—See the *Deployment Guide* at http://docs.redhat.com/docs/en-US/Red_Hat_Enterprise_Linux/5/html/Deployment_Guide/ch-raid.html.
- SLED 11—See the *Deployment Guide* at http://www.suse.com/documentation/sled11/book_sle_deployment/?page=/documentation/sled11/book_sle_deployment/data/book_sle_deployment.html.

For more information about Open Source and Linux at HP, go to <http://h10018.www1.hp.com/wwsolutions/linux/index.html>.

C System board designators

HP Z220 SFF Workstation

Designator	Silk screen	Component/Description
E15	E15	Crisis recovery header/jumper
E49	E49	Clear password header/jumper
J9	RJ45/USB	LAN/DUAL USB 2.0
J10	J10	Quad rear USB 3.0
J20	PCI1J20	PCI slot (white)
J31	J31 X1PCIEXP1	PCIe2 x1 slot (black)
J41	J41 X16PCIEXP	PCIe3 x16 slot (black)
J42	J42 X4PCIEXP	PCIe2 x16(4) slot (black)
J53	VGA/COMA	Serial port connector stacked over VGA port
J64	DISPLAYPORT	Display port connector
J68	PS2	Mouse connector stacked over keyboard connector
J78	IN/OUT	Audio line in stacked over audio line out
SW50	SW50 CMOS	Clear CMOS switch/push button
P1	PWR	Power supply, 6-pin (white)
P2	PWRCMD	Power command, 6-pin (white)
P3	PWRCPU	Power supply, 4-pin (white)
P5	P5 PB/LED	Front power button/LED (black)
P6	SPRK	Internal speaker (white)
P9	CHFAN1	Front chassis fan
P23	FRONT AUD	Front audio (blue)
P24	FRONT USB	Front I/O USB (yellow)
P25	FRONT USB2	Front I/O USB (green)
P52	COMB	Serial port
P124	HLCK	Hood lock solenoid (black)
P125	HSENSE	Hood sensor
P126	PAR	Flying parallel port (black)
P150	MEDIA	Media card reader
P151	MEDIA2	Media card reader

Designator	Silk screen	Component/Description
P160	SATAPWR1	HDD power (black)
XBT1	XBT1 BAT	Battery holder
XMM1 - XMM4	XMM1 - XMM4 DIMM1 - DIMM4	Memory slots
XU1	XU1	CPU socket

HP Z220 CMT Workstation

Designator	Silk screen	Component
E15	E15	Crisis recovery header/jumper
E49	E49	Clear password header/jumper
J9	J9 RJ/USB	LAN/DUAL USB
J10	J10 QUAD USB	Dual USB3.0/Dual USB2.0
J20	J20 SLOT6 PCI 32/33	PCI slot
J21	J21 SLOT7 PCI 32/33	PCI slot
J31	J31 SLOT3 PCIe2 x1	PCIe2 x1 slot
J32	J32 SLOT5 PCIe2 x1	PCIe2 x1 slot
J33	J33 SLOT1 PCIe2 x8(4)	PCIe2 x8(4) slot
J34	J34 SLOT4 PCIe2 x16(4)	PCI slot
J41	J41 SLOT2 PCIe3 x16 75W	PCIe3 x16 slot
J64	DP	Display port connector
J65	DVI	DVI-I connector
J68	J68 PS2	Stacked keyboard/mouse connector
J83	J83	Triple stacked audio jacks
J86	J86	Slot2 PCIe x16 retention clip
MTG1-MTG10	N/A	Mounting holes
P1	P1	Power supply connector (18-pin)
P3	P3 CPU PWR	CPU power connector (4-pin)
P5	P5	Power button/HDD LED/Power LED switch/Side access panel sensor/Temperature header
P6	SPKR	Speaker
P8	P8 CHFAN	Rear system fan
P9	P9	Front fan header
P24	P24 FRONT USB	Front panel USB header
P25	P25 INTERNAL USB2	Dual internal USB header

Designator	Silk screen	Component
P26	P26 INTERNAL USB3	Single internal USB header
P27	DASH/USB1	DASH/Dual internal USB
P29	P29 HDD LED	Hard disk drive LED connector
P54	COM	Serial port header
P60-P64	SATA0 - SATA4	SATA connectors
P65	eSATA	eSATA connector
P66 - P67	P66 - P67 SATA4 - SATA5	SATA connectors
P70	P70 CPU0 FAN	Primary CPU fan header
P124	P124 HOOD LOCK	Side access panel solenoid lock header
P126	PAR	Parallel port header
SW50	SW50 CMOS	Clear CMOS switch/push button
XBT1	XBT1 BAT	Battery holder
XMM1 - XMM4	XMM1 - XMM4 DIMM1 - DIMM4	Memory slots
XU1	XU1	Primary CPU socket

HP Z420 and Z620 Workstation system board designators

Designator	Name on board	Component
E14	BB	ROM bootblock header
E15	BBR	ROM bootblock recovery header
E16	ROM RCVRY	ROM Recovery header/jumper
E17	LPC	LPC Debug
E49/JP49	PSWD	Clear Password header
J9	RJ45/USB	Stacked RJ45/Dual USB
J10	USB	Quad Stacked USB
J20-22	PCIx (x=1-3)	PCI slots
J31-32	X1PCIEXPx (x=1-2)	PCI Express X1 slot
J41	X16PCIEXP or MXM	PCI Express x16 or MXM graphics slot
J42	X4PCIEXP	PCI Express x4 graphics slot
J68	PS2	Stack keyboard/mouse connector
J69	VGA or VGA/COMA	VGA connector or VGA+serial port
J70	USB	Primary Single USB

Designator	Name on board	Component
J71	USB	Secondary Single USB
J90	USB	3rd Single USB
J91	USB	4th Single USB
J72	MIC	Microphone jack
J73	IN	Line-In audio jack
J74	OUT	Line-out audio jack
J76	HDPH	Headphone jack
J77	PH/MIC	Double Stacked PH/MIC
J78	IN/OUT	Double Stacked Line-in/out
J80	SER/AUD	Stacked Serial/Audio
J81	USB	Primary Double USB
J82	USB	Secondary Double USB
J83	AUD	Triple Stacked Audio
J103	PWR	DC Input Power
P1	PWR	P/S connector
P2	PWRMEM	P/S memory power connector
P3	PWRCPU	VCCP 12V header
P4 (Z620 only)	PWRCPU2	P/S 2nd CPU & Memory 12V Connector
P5	PB/LE	Control panel
P6	SPKR	Speaker connector
P8	CPUFAN	CPU fan header
P9	CHFAN	Front chassis fan header
P10	FLOPPY	Floppy header
P11	CHFAN2	Rear chassis fan header (Z620)
P23	FRONT AUD	Header for Front Panel Audio
P24/25	FRONT USB/FRONT USB2	Header for Front Panel USB
P52	COMAB	Header/Connector for 2nd Serial Port
P54	COMA	Header/Connector for 1st Serial Port
P60	SATA0	SATA0 connector
P61	SATA1	SATA1 connector
P626	SATA2	SATA2 connector
P63	SATA3	SATA3 connector
P66	SATA4	SATA4 connector
P91	P91	Z620 memory fan

Designator	Name on board	Component
P92	P92	Z420 memory fan
P95	CHFAN2	Rear chassis fan header (Z420)
P125	SATA4	Hood sense (Z420)

HP Z820 Workstations

Designator	Name on board	Component
E1/JP1	SPI	BIOS ME/AMT Flash Override Header
E15/JP15		BIOS Crisis Recovery Header
E49/JP49	PSWR	Password Clear Jumper
J2	SAS OPT	SAS Option ROM Header
J9	RJ-45/USB	Stacked RJ-45/Dual USB 2.0
J11	RJ-45/USB2.0	Stacked RJ-45/Dual USB 2.0
J12	1394A/USB3.0	Stacked 1394a/Dual USB 3.0
J13	FRONT 1394A	Front 1394a
J20	J20 SLOT7-PCI	PCI 32/33 Slot
J31	J31 SLOT1-PCIe3 x8(4)	PCI Express Gen 3 x8(4) Slot, Open-Ended
J32	J32 SLOT5-PCIe2 x8(4)	PCI Express Gen 2 x8 (4) Slot, Open-Ended
J33	J33 SLOT4-PCIe3 x16	PCI Express Gen 3 x16 Graphics Slot
J34	J34 SLOT3-PCIe3 x16(8)	PCI Express Gen 3 x16(8) Slot
J41	J41 SLOT2-PCIe3 x16	PCI Express Gen 3 x16 Graphics Slot
J42	J42 SLOT6-PCIe3 x16	PCI Express Gen 3 x16 Graphics Slot
J68	PS2	Stacked Keyboard/Mouse
J83		Triple Stacked Audio
P1	MAIN POWER	Main Power Connector
P2	MEM PWR	Memory Power Connector
P3	CPU0 PWR	CPU0 Power Connector
P4	CPU1 PWR	CPU1 Power Connector
P5	FRONT UI	Front Power Button/LED/Speaker Header
P8	REAR FANS	Rear Chassis Fans Header
P24	USB 2.0	Internal USB 2.0 2x5 Header
P25	USB 2.0	Internal USB 2.0 2x5 Header
P26	USB 2.0 DASH	Internal USB 2.0 2x5 Header
P27	FRONT USB 2.0	Front USB 2.0 Header

Designator	Name on board	Component
P28	FRONT AUDIO	Front Audio
P29	Front USB 3.0	Front USB 3.0 Header
P54	SERIAL	Serial Port
P60	SATA0	AHCI SATA0 Connector
P61	SATA1	AHCI SATA1 Connector
P62	SCU3	SCU SATA3 Connector
P63	SCU2	SCU SATA2 Connector
P64	SCU1	SCU SATA1 Connector
P65	SCU0	SCU SATA0 Connector
P70	CPU+MEM FANS	CPU and Memory Fans
P80	SAS0	SAS/SATA Port 0
P81	SAS1	SAS/SATA Port 1
P82	SAS2	SAS/SATA Port 2
P83	SAS3	SAS/SATA Port 3
P84	SAS4	SAS/SATA Port 4
P85	SAS5	SAS/SATA Port 5
P86	SAS6	SAS/SATA Port 6
P87	SAS7	SAS/SATA Port 7
P93	FRNT FAN2	Front Fan 2 Header
P94	FRNT FAN1	Front Fan 1 Header
P125	LC1	Liquid Cooling Header 1
P126	LC0	Liquid Cooling Header 0
SW3	SW3	Rear Power Button/LED
SW50	CMOS	Clear CMOS Button
XBT1	XBT1	Battery
XMM1	CPU0-DIMM8	CPU0 Memory DIMM8
XMM2	CPU0-DIMM7	CPU0 Memory DIMM7
XMM3	CPU0-DIMM6	CPU0 Memory DIMM6
XMM4	CPU0-DIMM5	CPU0 Memory DIMM5
XMM5	CPU0-DIMM1	CPU0 Memory DIMM1
XMM6	CPU0-DIMM2	CPU0 Memory DIMM2
XMM7	CPU0-DIMM3	CPU0 Memory DIMM3
XMM8	CPU0-DIMM4	CPU0 Memory DIMM4
XMM9	CPU1-DIMM1	CPU1 Memory DIMM1

Designator	Name on board	Component
XMM10	CPU1-DIMM2	CPU1 Memory DIMM2
XMM11	CPU1-DIMM3	CPU1 Memory DIMM3
XMM12	CPU1-DIMM4	CPU1 Memory DIMM4
XMM13	CPU1-DIMM8	CPU1 Memory DIMM8
XMM14	CPU1-DIMM7	CPU1 Memory DIMM7
XMM15	CPU1-DIMM6	CPU1 Memory DIMM6
XMM16	CPU1-DIMM5	CPU1 Memory DIMM5

Index

- B**
 - BIOS ROM 40
- C**
 - Cable management 78
 - CMOS 153
 - clearing and resetting 155
 - Computer Setup (F10) Utility 41
 - Menu description 43
 - Configuring RAID devices 161
 - maximum hard drives allowed 161
 - SAS RAID on LSI 2308 or LSI 9212-4i controllers 166
 - SAS RAID on LSI 9260-8i MegaRAID controller 169
 - SATA RAID 163
- D**
 - Desktop management 57
 - Altiris Client Management Solutions 60
 - FailSafe Boot Block ROM 61
 - Fault notification and recovery 72
 - HP Client Manager Software 60
 - HP SoftPaq Download Manager 60
 - HPQFlash 61
 - Initial configuration 58
 - programmable power button 73
 - Remote ROM Flash 61
 - Remote system install 58
 - ROM Flash 61
 - System Software Manager 61
 - Updating software 60
 - Workstation security 62
 - Diagnostic codes and errors 145
 - LED and beep codes 145
 - LED colors 148
 - POST errors 148
 - Diagnostics 112
 - Diagnostics and troubleshooting
 - Diagnosis guidelines 115
 - HP PC Hardware Diagnostics 140
 - HP Vision Diagnostics 131
 - Locating ID labels 114
 - Locating warranty info 115
 - DIMM configurations, supported 98
 - DIMM installation order
 - HP Z420 Workstation 100, 101
 - HP Z620 Workstation 102
 - HP Z820 Workstation 103
- E**
 - Expansion card slot identification
 - HP Z220 CMT Workstation 83
 - HP Z220 SFF Workstation 81
 - HP Z420 Workstation 85
 - HP Z620 Workstation 87
 - HP Z820 Workstation 89
- M**
 - Memory
 - DIMM installation guidelines 99
- O**
 - Operating system setup 157
- P**
 - Password configuration 153
 - Password jumper
 - resetting 154
 - Power supply
 - Expansion card configuration restrictions 80
 - power consumption 106
 - resetting 106
 - specifications 104
 - Product features 1
 - Computer components 4
 - ERP compliance mode 38
 - Front panel components 2
 - HP Cool Tools 39
 - Hyper-threading 39
 - Physical characteristics 7, 14, 21, 28, 35
 - Rear panel components 3, 9, 10
 - SATA Power Management 39
 - System board architecture 6, 13, 20, 27
 - Turbo Boost 39
 - Product overview 1
- R**
 - Replacing components
 - Battery 77
 - cable management 78
 - Component locations 5, 12, 19, 26, 33
 - CPU (processor) and CPU heatsink 79
 - expansion slots 80
 - guidelines 77
 - hard disk drive 91
 - information and guidelines 74
 - Memory 98
 - power supply 104
 - Service considerations 75
 - warnings and cautions 74
- S**
 - System board components 5
 - System board designators 173
 - System management 38
- T**
 - Troubleshooting 112
- W**
 - Workstation components
 - HP Z420 Workstation 15
 - HP Z420 Workstation front panel 16
 - HP Z420 Workstation rear panel 17
 - HP Z620 Workstation 23

HP Z620 Workstation chassis
25

HP Z620 Workstation front
panel 23

HP Z620 Workstation rear
panel 24

HP Z820 Workstation 30

HP Z820 Workstation chassis
32

HP Z820 Workstation front
panel 30

HP Z820 Workstation rear
panel 31

Workstation setup

Ensuring proper ventilation 37